

SpecialWheels



Nitro Aero FF G.Blk



Nitro Spark G.Blk/Red



Nitro Throne FF

FÄLGAR & TILLBEHÖR 2021



Fälgar • Mutter & bult • Kåpor • Navringar • Spacers • Fälgås
Ventiler & TPMS • Mätverktyg • Vikter • Monteringstillbehör

Nordens största oberoende fälgleverantör.

NYTT INFÖR VÅREN 2021

Vi fortsätter lanseringen av monteringsmaterial från Italmatic! Nu utökar vi med fler ventiler - även för lastbilar, TPMS och programmeringsverktyg, fler vikter, verktyg, lyftblock osv.

Bland fälgnyheterna finner ni bland andra:

Nitro Aero FF – originalanpassad för Tesla, OE cap code 6005879-00-A, nu även till andra bilar.

Nitro Throne FF – nu även i 21”

Image Montana – ny pick-up fälg i 20” även till Mercedes Sprinter.

MSW 27T – dedikerad för Tesla 3 och Y, OE cap code 6005879-00-A.

MSW 50 – sportig fälg i mesh-design från MSW lackad i blank svart.

MSW 85 – klassisk sportig design lackad i blank svart.

Lättviktsfälgar – viktexempel

Fälgmodell	Vikt kg/st	Fälgmodell	Vikt kg/st	Fälgmodell	Vikt kg/st
Nitro Throne FF		Nitro Turismo FF		Nitro Aero FF	
8,5x20 5-108 E40 C63,3	11,9	8x19 5-108 E50 C63,3	11,2	8,5x18 5-114,3 E40 C70/64	10,7
9x20 5-108 E40 C63,3	12,3	8,5x19 5-108 E45 C63,3	12,1	8x19 5-120 E40 C64,1	11,8
10x20 5-112 E40 C66,4	12,1	9x19 5-108 E53 C63,3	11,7	8,5x19 5-114,3 E40 CC70/64	11,8
10,5x20 5-112 E40 C66,4	12,7	9,5x19 5-112 E50 C66,5	12,3	8x20 5-108 E50 C63,3	12,3
9x22 5-108 E40 C63,3	13,6	10x19 5-112 E50 C66,5	12,4	8,5x20 5-114,3 E35 CC70/64	13,3
9,5x22 5-108 E42 C63,3		10,5x19 5-112 E25 C66,5	13,2	9x20 5-108 E53 C63,3	13,3
10,5x22 5-112 E40 C66,4	14,5	8x20 5-108 E50,5 C63,3	12,5		
11x22 5-112 E45 C66,4	14,4	8,5x20 5-108 E45 C63,3	13,1		
		9x20 5-108 E58,5 C63,3	13,1		
Nitro Sapphire FF		9,5x20 5-130 E64 C71,6	13,1		
7,5x18 5-108 E50 C63,3	10,1	10x20 5-112 E50 C66,5	13,6		
8x18 5-108 E42 C63,3	11	10,5x20 5-130 E64 C71,5	13,2		
8,5x18 5-114,3 E40 C64,1	11,3	11x20 5-130 E58 C71,5	13,6		
7,5x19 5-108 E50 C63,3	11,3	11,5x20 5-130 E64 C71,5	14,1		
8x19 5-108 E42 C63,3	11,5				
8,5x19 5-108 E56 C63,3	11,6				
8x20 5-108 E50 C63,3	12,8				
8,5x20 5-108 E47 C63,3	12,8				
9x20 5-108 E53 C63,3	13,4				



2. Nitro Aero FF G.Gun/Pol



4. Nitro Throne FF



61. Image Montana Slv



75. MSW 50 G.Blk



79. MSW 27T G.Gun



82. MSW 85 G.Blk

INNEHÅLLSFÖRTECKNING

Caps – Emblem	Sid.
Advanti	4-5
CSP	5-6
Nitro	7-9
BM Wheels	10-11
Team Dynamics	11
Ballistic, Incubus & PCW	12
Image	13-15
Breyton	16
ATS	17
4X4	17
Spacers	18
Mutter – Bult – Fälgåls	19-21
Bimecc OEM Mutter/bult	22-36
Monteringstillbehör Italmatic	37-43
Mätverktyg	43
Speedline Truck Ventiler och ventilförlängare	44
Centreringsringar	45
Satser	46-48
Villkor	49
Stålfälgar för lastbilar bussar och släpvagnar	50-51
Speedline lastbilsfälgar	52-53
Prislista sortiment 2021	54-57
Prislista beställningssortiment 2021	58-89
Sortiment 2021	90-95

Advanti



Bild	Modell	Märkning	Ytter dia. (mm)	Inner dia. (mm)	Djup (mm)	Pris Exkl.	Cap + Logo	Cap	Logo
4	Advanti Falcon*	PC286-1-C Beskrivning: Advanti Racing Blk	110 total		106 höjd Dia. (mm): 60 kvx	160:-	x	07005046	x
7	Advanti Forza	C590 Beskrivning: Advanti Racing Car	55	50	11 Dia. (mm): 56 plan	100:-	07005028	07005029	07006031
2	Advanti Nebullar*	PC993 Beskrivning: Advanti Blk	69 total		10 höjd Dia. (mm): 50 plan	100:-	07005043	x	x
8	Advanti Nova (6-114)	C118-2-20 Beskrivning: Advanti Blk	113 total		37 plan Dia. (mm): 37 plan	160:-	07005093	07005094	07006027
8	Advanti Nova (6-139,7)	C118-1-20 Beskrivning: Advanti Blk	137 total		54 plan Dia. (mm): 54 plan	160:-	07005095	07005096	07006028
7	Advanti Black Pearl	XC287CH Beskrivning: Advanti Racing G.Blk	62,5	57,6	Dia. (mm):	100:-	07005145	07005004	07006038
12	Advanti Inizio DST	XC647VW M.Blk Beskrivning: Advanti Blk			60 kvx Dia. (mm): 60 kvx	100:-	07005044	07005124	07006047
9	Advanti Pulsar (6-114)	C118-2-20 Beskrivning: Advanti Blk	113 total		37 plan Dia. (mm): 37 plan	160:-	07005099	07005100	07006027
9	Advanti Pulsar (6-139,7)	C118-1-20 Beskrivning: Advanti Blk	137 total		54 plan Dia. (mm): 54 plan	160:-	07005101	07005102	07006028
3	Advanti Raid/Peak	C-098-A Beskrivning: Advanti Racing Slv	71,2	63,7	14,3 Dia. (mm): 62 kvx	100:-	07005047	x	07006022
3	Advanti Raid (5-112)	XC585A-C Beskrivning: Advanti Racing Slv			60 kvx Dia. (mm): 60 kvx	100:-	x	07005007	x
6	Advanti Raptor	XC287C Beskrivning: Advanti Racing Car	62,5	57,6	9,7 Dia. (mm): 62 kvx	100:-	07005080	07005016	07006026
11	Advanti Siren	C398-MGM6 Beskrivning: Advanti Racing Car			65 kvx Dia. (mm): 65 kvx	100:-	07005113	07005114	07006016
9	Advanti Titan (5-139,7)	C118-6-20 Beskrivning: Advanti Blk			54 plan Dia. (mm): 54 plan	160:-	07005135	07005136	07006028
9	Advanti Titan (6-114)	C398C Beskrivning: Advanti Racing Slv			62 kvx Dia. (mm): 62 kvx	160:-	07005159	07005034	07006041
9	Advanti Titan (6-139,7)	C118-1-20 Beskrivning: Advanti Blk	137 total		54 plan Dia. (mm): 54 plan	160:-	07005101	07005102	07006028
9	Advanti Titan M.Gun (5-139,7)	C118-6-20 Beskrivning: Advanti Blk			54 plan Dia. (mm): 54 plan	160:-	07005150	07005151	07006028
9	Advanti Titan M.Gun (6-114)	C398-MGM6 Beskrivning: Advanti Blk			62 kvx Dia. (mm): 62 kvx	160:-	07005154	07005114	07006043
9	Advanti Titan M.Gun (6-139,7)	C118-1-20 Beskrivning: Advanti Blk		137 total	54 plan Dia. (mm): 54 plan	160:-	07005152	07005153	07006028

Advanti

Bild	Modell	Märkning	Ytter dia. (mm)	Inner dia. (mm)	Djup (mm)	Pris Exkl.	Cap + Logo	Cap	Logo
1	Advanti Touring*	C-G96-R Beskrivning: Advanti Racing Blk	65	60	9,4 Dia. (mm): 62 kvx	100:-	x	07005061	07006018
1	Advanti Touring <100*	PCG45-R Beskrivning: Advanti Racing Blk	56,4	52	10 Dia. (mm): 62 kvx	100:-	x	07005060	07006018
10	Advanti Viper / Trophy	C287 Beskrivning:	62	57	10 Dia. (mm): 62 kvx	100:-	07005026	07005016	07006003
5	Advanti Vulkan*	C287 Beskrivning: Advanti Racing Slv	62,5	57,6	9,7 Dia. (mm): 62 kvx	100:-	07005026	07005016	07006003

* Utgår vid slut

CSP



Bild	Modell	Märkning	Ytter dia. (mm)	Inner dia. (mm)	Djup (mm)	Pris Exkl.	Cap + Logo	Cap	Logo
2	CSP 5/Trailer	PCF56 Beskrivning: CSP Slv	62,5	57,4	8,6 Dia. (mm): 60 plan	100:-	x	07005068	07006051
2	CSP 5/Trailer 4/5-100	PCF86-C Beskrivning: CSP Slv	56,5	51	8,9 Dia. (mm): 60 plan	100:-	x	07005069	07006051
1	CSP 6*	C-G96 Beskrivning: CSP Slv	65	60	9,4 Dia. (mm): 62 kvx	100:-	07005066	07005053	07006054
1	CSP 6 (5-112*)	R200 Beskrivning: CSP Slv	72	64	14 Dia. (mm): 62 kvx	100:-	x	07005081	07006058
1	CSP 7/11 5-112*	A05 Beskrivning: CSP Slv	56,5 59,6	51	10 Dia. (mm): 60 kvx	100:-	09005055	09005043	09006009
1	CSP 8 PCD <100	PCW3B Beskrivning: CSP Slv	55	50	8 Dia. (mm): 55 kvx	100:-	09005058	09005003	09006008
1	CSP 8 PCD >100	PCW3B-60 Beskrivning: CSP Slv	62	57	9 Dia. (mm): 65 kvx	100:-	09005059	09005038	09006010
1	CSP Work <100	PCW3B Beskrivning: CSP Slv	55	50	9 Dia. (mm): 55 kvx	100:-	09005058	09005003	09006008
1	CSP Work >100	PCW3B-60 Beskrivning: CSP Slv	62	56	10,5 Dia. (mm): 64 kvx	100:-	09005060	09005038	09006019
1	CSP Work (Et 62)	Mercy Polos Beskrivning: CSP Slv			70 plan Dia. (mm): 70 plan	100:-	09005063	09005061	09006024
3	CSP 10	C-043 Beskrivning: CSP Slv	67	60	12 Dia. (mm): 62 plan	100:-	02005008	02005009	02006006
3	CSP 10 (5-112)	C-137 Beskrivning: CSP Slv	53	46,7	10,8 Dia. (mm): 53 plan	100:-	02005037	02005035	02006032
4	CSP 10 M.Blk	C-043 Beskrivning: CSP Blk	67	60	12 Dia. (mm): 62 plan	100:-	02005016	02005015	02006008
4	CSP 10 M.Blk (5-112)	C-137 Blk Beskrivning: CSP Blk	53	46,7	10,8 Dia. (mm): 53 plan	100:-	02005038	02005036	02006033
6	CSP 12	VV-05 Beskrivning: CSP Slv	62,2	56,5	15,6 Dia. (mm): 63 plan	100:-	02005013	02005011	02006010
5	CSP 12 M.Gun	VV-05 Beskrivning: CSP Blk	62,2	56,5	15,6 Dia. (mm): 63 plan	100:-	02005014	02005011	02006011

* Utgår vid slut

CSP

Bild	Modell	Märkning	Ytter dia. (mm)	Inner dia. (mm)	Djup (mm)	Pris Exkl.	Cap + Logo	Cap	Logo
	CSP 13 (5-100)	XC648VW Beskrivning: CSP Slv			Dia. (mm): 50 kvx	100:-	07005160	07005161	07006074
3	CSP 13	XC647VW Beskrivning: CSP Slv			Dia. (mm): 60 kvx	100:-	07005125	07005123	07006070
	CSP 13 M.Gun (5-100)	XC648VW Blk Beskrivning: CSP Blk			Dia. (mm): 50 kvx	100:-	07005162	07005163	07006075
4	CSP 13 M.Gun	XC647VW Blk Beskrivning: CSP Blk			Dia. (mm): 60 kvx	100:-	07005126	07005124	07006071
3	CSP 14	XC566VW Beskrivning: CSP Slv			Dia. (mm): 60 kvx	100:-	07005129	07005127	07006070
4	CSP 14 M.Blk	XC566VW Blk Beskrivning: CSP Blk			Dia. (mm): 60 kvx	100:-	07005130	07005128	07006071
3	CSP 15	R200 Beskrivning: CSP Slv			Dia. (mm): 60 kvx	100:-	07005120	07005081	07006068
4	CSP 15 M.Blk	R200 blk Beskrivning: CSP Blk			Dia. (mm): 60 kvx	100:-	07005121	07005122	07006069
3	CSP 16 PCD <100	PCW3B Beskrivning: CSP Slv	55	50	8 Dia. (mm): 55 kvx	100:-	09005120	09005003	09006027
3	CSP 16 PCD >100	PCW3B-60 Beskrivning: CSP Slv	62	57	9 Dia. (mm): 65 kvx	100:-	09005121	09005038	09006028
4	CSP 16 M.Gun PCD <100	PCW3B FSDG Beskrivning: CSP Blk	55	50	8 Dia. (mm): 55 kvx	100:-	09005069	09005068	09006029
4	CSP 16 M.Gun PCD >100	PCW3B-60 FSDG Beskrivning: CSP Blk	62	57	9 Dia. (mm): 65 kvx	100:-	09005071	09005070	09006030
6	CSP 17	VV-05 Beskrivning: CSP Slv	62,2	56,5	15,6 Dia. (mm): 63 plan	100:-	02005013	02005011	02006010
6	CSP 17 G.Blk/Pol	VV-05 Beskrivning: CSP Slv	62,2	56,5	15,6 Dia. (mm): 63 plan	100:-	02005014	02005011	02006011
	CSP 18 (5-112)	C-137 Beskrivning: CSP Slv	53	46,7	10,8 Dia. (mm): 53 plan	100:-	02005078	02005077	02006032
	CSP 18 (5-120)	C-043 Beskrivning: CSP Slv	67	60	12 Dia. (mm): 62 plan	100:-	02005076	02005075	02006006
	CSP 18 G.Blk (5-112)	C-137 Beskrivning: CSP G.Blk	53	46,7	10,8 Dia. (mm): 53 plan	100:-	02005082	02005081	02006048
	CSP 18 G.Blk (5-120)	C-043 Beskrivning: CSP G.Blk	67	60	12 Dia. (mm): 62 plan	100:-	02005080	02005079	02006047
	CSP 18 G.Blk/Pol (5-112)	C-137 Beskrivning: CSP G.Blk	53	46,7	10,8 Dia. (mm): 53 plan	02005082	02005081	02006048	
	CSP 18 G.Blk/Pol (5-120)	C-043 Beskrivning: CSP G.Blk	67	60	12 Dia. (mm): 62 plan	02005080	02005079	02006047	

* Utgår vid slut



Nitro



Bild	Modell	Märkning	Ytter dia. (mm)	Inner dia. (mm)	Djup (mm)	Pris Exkl.	Cap + Logo	Cap	Logo
5	Nitro Daytona*	C-015 Beskrivning: Nitro Slv				100,-	02005025	02005029	02006031
7	Nitro Demon Pcd <112	XC566VW Blk Beskrivning: Nitro Blk				100,-	07005132	07005128	07006072
7	Nitro Demon Pcd >110	XC287MB Beskrivning: Nitro Blk	62,5	57,6	9,7	100,-	07005134	07005106	07006073
6	Nitro Demon H.Slv Pcd <112	XC566VW Beskrivning: Nitro Slv				100,-	07005131	07005127	07006024
6	Nitro Demon H.Slv Pcd >110	XC287 Beskrivning: Nitro Slv	62,5	57,6	9,7	100,-	07005133	07005004	07006015
4	Nitro Edge	C398-MGM6 Beskrivning: Nitro Blk				100,-	07005117	07005114	07006034
4	Nitro Edge M.Blk	C398-MB Beskrivning: Nitro Blk				100,-	07005018	07005017	07006034
6	Nitro Epic (5-108)	VV-05 Beskrivning: Nitro Slv	62,2	56,5	15,6	100,-	02005057	02005011	02006038
6	Nitro Epic (5-112 Et 21)	C-140 Beskrivning: Nitro Slv	47	44	12,5	100,-	02005058	02005062	02006036
6	Nitro Epic (5-112)	C-284-1 Beskrivning: Nitro Slv	55	48,4	8	100,-	02005059	02005002	02006036
6	Nitro Epic (5-120 - 5-130)	C-043 Beskrivning: Nitro Slv	67	60	12	100,-	02005060	02005009	02006037
6	Nitro Epic M.Gun (5-108)	VV-05 Beskrivning: Nitro Blk	62,2	56,5	15,6	100,-	02005053	02005011	02006039
6	Nitro Epic M.Gun (5-112 Et 21)	C-140 Blk Beskrivning: Nitro Blk	47	44	12,5	100,-	02005054	02005063	02006012
6	Nitro Epic M.Gun (5-112)	C-284-1 Beskrivning: Nitro Blk	55	48,4	8	100,-	02005055	02005002	02006012
7	Nitro Epic M.Gun (5-120 - 5-130)	C-043 Blk Beskrivning: Nitro Blk	67	60	12	100,-	02005056	02005015	02006035
4	Nitro Hammer	C398-MGM6 Beskrivning: Nitro Blk				100,-	07005117	07005114	07006034
4	Nitro Magnum	C398-MGM6 Beskrivning: Nitro Blk				100,-	07005117	07005114	07006034
4	Nitro Magnum HL	C398-MGM6 Beskrivning: Nitro Blk				100,-	07005117	07005114	07006034
3	Nitro Mystic*	XC987-MB Beskrivning: Nitro Slv	64,8	60	16,2	100,-	x	07005008	07006025
1	Nitro Octane*	C-284-1 Beskrivning: Nitro Slv	55	48,4	7,8	100,-	02005006	02005002	02006002

* Utgår vid slut

Nitro

Bild	Modell	Märkning	Ytter dia. (mm)	Inner dia. (mm)	Djup (mm)	Pris Exkl.	Cap + Logo	Cap	Logo
6	Nitro Razor Pcd <112	XC566VW Beskrivning: Nitro Slv			Dia. (mm): 60 kvx	100:-	07005131	07005127	07006024
6	Nitro Razor Pcd >110	XC287CH Beskrivning: Nitro Slv	62,5	57,6	9,7 Dia. (mm): 62 kvx	100:-	07005133	07005004	07006015
7	Nitro Razor M.Gun Pcd <112	XC566VW-MB Beskrivning: Nitro Blk			Dia. (mm): 60 kvx	100:-	07005132	07005128	07006072
7	Nitro Razor M.Gun Pcd >110	XC287-MB Beskrivning: Nitro Blk	62,5	57,6	9,7 Dia. (mm): 62 kvx	100:-	07005134	07005106	07006073
8	Nitro Sabre (5-108/112)	XC566V-BR Beskrivning: Nitro Bronze			Dia. (mm): 60 kvx	100:-	07005146	07005147	07006039
8	Nitro Sabre (5-114/120)	CXC287-BR Beskrivning: Nitro Bronze	62,5	57,6	9,7 Dia. (mm): 62 kvx	100:-	07005148	07005149	07006040
9	Nitro Sabre G.Blk (5-114)	XC287-GB Beskrivning: Nitro G.Blk			Dia. (mm): 62 kvx	100:-	07005082	07005083	07006108
9	Nitro Sabre G.Blk	XC566VW-GB Beskrivning: Nitro G.Blk			Dia. (mm): 60 kvx	100:-	07005042	07005041	07006107
11	Nitro Sapphire FF (5-108)	XCVOL-GM Beskrivning: Nitro G.Gun			Dia. (mm): 60 kvx	100:-	07005169	07005175	07006079
11	Nitro Sapphire FF	XC566VW-G.Gun Beskrivning: Nitro G.Gun			Dia. (mm): 60 kvx	100:-	07005084	07005085	07006080
9	Nitro Spark (5-108)	C398-G.Blk Beskrivning: Nitro G.Blk			Dia. (mm): 65 kvx	100:-	07005157	07005158	07006042
9	Nitro Spark	C073A-G.Blk Beskrivning: Nitro G.Blk			Dia. (mm): 65 kvx	100:-	07005155	07005156	07006042
9	Nitro Spark G.Blk/Grey (5-108)	C398-G.Blk Beskrivning: Nitro G.Blk			Dia. (mm): 65 kvx	100:-	07005157	07005158	07006042
9	Nitro Spark G.Blk/Grey	C073A-G.Blk Beskrivning: Nitro G.Blk			Dia. (mm): 65 kvx	100:-	07005155	07005156	07006042
9	Nitro Spark G.Blk/Red (5-108)	C398-G.Blk Beskrivning: Nitro G.Blk			Dia. (mm): 65 kvx	100:-	07005157	07005158	07006042
9	Nitro Spark G.Blk/Red	C073A-G.Blk Beskrivning: Nitro G.Blk			Dia. (mm): 65 kvx	100:-	07005155	07005156	07006042
4	Nitro Speed	C398-MGM6 Beskrivning: Nitro Blk			Dia. (mm): 65 kvx	100:-	07005117	07005114	07006034
4	Nitro Speed M.Gun	C398-MGM6 Beskrivning: Nitro Blk			Dia. (mm): 65 kvx	100:-	07005117	07005114	07006034
2	Nitro Sprint Pcd 100/108*	XC-585 Beskrivning: Nitro Slv	54	51	10,6 Dia. (mm): 50 kvx	100:-	07005077	07005006	07006023
2	Nitro Sprint Pcd >110*	XC585A Beskrivning: Nitro Slv	62,5	57,6	9,5 Dia. (mm): 60 kvx	100:-	07005078	07005007	07006024
6	Nitro Spyder (5-108)	VV-05 Beskrivning: Nitro Slv	62,2	56,5	15,6 Dia. (mm): 63 kvx	100:-	02005067	02005011	02006041
6	Nitro Spyder (5-112)	C-143 Beskrivning: Nitro Slv			Dia. (mm): 62 kvx	100:-	02005065	02005064	02006042
6	Nitro Spyder (5-120)	C-043 Beskrivning: Nitro Slv	67	60	12 Dia. (mm): 62 kvx	100:-	02005066	02005009	02006042
6	Nitro Spyder	C-284-1 Beskrivning: Nitro Slv	55	48,4	8 Dia. (mm): 60 plan	100:-	02005006	02005002	02006002
7	Nitro Spyder G.Blk/Pol (5-108)	VV-05 Beskrivning: Nitro Blk	62,2	56,5	15,6 Dia. (mm): 63 kvx	100:-	02005072	02005011	02006043
7	Nitro Spyder G.Blk/Pol (5-112)	C-143-MBK Beskrivning: Nitro Blk			Dia. (mm): 62 kvx	100:-	02005069	02005068	02006044
7	Nitro Spyder G.Blk/Pol (5-120)	C-043 Blk Beskrivning: Nitro Blk	67	60	12 Dia. (mm): 62 kvx	100:-	02007073	02005015	02006044
7	Nitro Spyder G.Blk/Pol	C-284-1 Beskrivning: Nitro Blk	55	48,4	8 Dia. (mm): 60 plan	100:-	02005074	02005002	02006045
12	Nitro Throne FF (5-108)	XCVOL G.Blk Beskrivning: Nitro G.Blk			Dia. (mm): 60 kvx	100:-	07005203	07005204	07006109
12	Nitro Throne FF	XC647VW G.Blk Beskrivning: Nitro G.Blk			Dia. (mm): 60 kvx	100:-	07005206	07005207	07006107

* Utgår vid slut

Nitro

Bild	Modell	Märkning	Ytter dia. (mm)	Inner dia. (mm)	Djup (mm)	Pris Exkl.	Cap + Logo	Cap	Logo
11	Nitro Turismo FF (5-108) Beskrivning: Nitro G.Gun	C-154 Nitro G.Gun			Dia. (mm):	100:-	02005084	02005083	02006052
11	Nitro Turismo FF (5-112 60° Kona) Beskrivning: Nitro G.Gun	C-137Gm Nitro G.Gun			Dia. (mm):	100:-	02005086	02005085	02006049
11	Nitro Turismo FF (5-112 R14) Beskrivning: Nitro G.Gun	C-140Gm Nitro G.Gun			Dia. (mm):	100:-	02005088	02005087	02006050
11	Nitro Turismo FF Beskrivning: Nitro G.Gun	C-C43Gm Nitro G.Gun			Dia. (mm):	100:-	02005090	02005089	02006051
11	Nitro Turismo FF G.Gun/Pol (5-108) Beskrivning: Nitro G.Gun	C-154 Nitro G.Gun			Dia. (mm):	100:-	02005084	02005083	02006048
11	Nitro Turismo FF G.Gun/Pol (5-112 60° Kona) Beskrivning: Nitro G.Gun	C-137Gm Nitro G.Gun			Dia. (mm):	100:-	02005086	02005085	02006049
11	Nitro Turismo FF G.Gun/Pol (5-112 R14) Beskrivning: Nitro G.Gun	C-140Gm Nitro G.Gun			Dia. (mm):	100:-	02005088	02005087	02006050
11	Nitro Turismo FF G.Gun/Pol Beskrivning: Nitro G.Gun	C-C43Gm Nitro G.Gun			Dia. (mm):	100:-	02005090	02005089	02006051
4	Nitro Ultra Beskrivning: Nitro Blk	C398-MGM6 Nitro Blk			Dia. (mm): 65 kvx	100:-	07005117	07005114	07006034
6	Nitro Volcano (5-108) Beskrivning: Nitro Slv	XCVOL Nitro Slv			Dia. (mm): 60 kvx	100:-	07005165	07005014	07006076
6	Nitro Volcano (5-112 Radius Kona) Beskrivning: Nitro Slv		XC647VW		Dia. (mm): 60 kvx	100:-	07005166	07005123	07006024
6	Nitro Volcano (5-112 60° Kona) Beskrivning: Nitro Slv		XC512-S-BW		Dia. (mm): 56 kvx	100:-	07005167	07005174	07006077
6	Nitro Volcano (5-120) Beskrivning: Nitro Slv		XC512BW		Dia. (mm): 65,5 kvx	100:-	07005168	07005173	07006078
10	Nitro Volcano G.Gun (5-108) Beskrivning: Nitro Gm		XCVOL-GM		Dia. (mm): 60 kvx	100:-	07005169	07005175	07006079
10	Nitro Volcano G.Gun (5-112 Radius Kona) Beskrivning: Nitro Gm		XC647VW-GM		Dia. (mm): 60 kvx	100:-	07005170	07005176	07006080
10	Nitro Volcano G.Gun (5-112 60° Kona) Beskrivning: Nitro Gm		XC512-S-BW		Dia. (mm): 56 kvx	100:-	07005171	07005174	07006081
10	Nitro Volcano G.Gun (5-120) Beskrivning: Nitro Gm		XC512BW-GM		Dia. (mm): 65,5 kvx	100:-	07005172	07005177	07006082
10	Nitro Volcano G.Gun (5-112 Radius Kona) Beskrivning: Nitro Gm		XC647VW-GM		Dia. (mm): 60 kvx	100:-	07005170	07005176	07006080
10	Nitro Volcano G.Gun (5-112 60° Kona) Beskrivning: Nitro Gm		XC512-S-BW		Dia. (mm): 56 kvx	100:-	07005171	07005174	07006081
10	Nitro Volcano G.Gun (5-120) Beskrivning: Nitro Gm		XC512BW-GM		Dia. (mm): 65,5 kvx	100:-	07005172	07005177	07006082
15	Nitro Aero D.Slv Beskrivning: Nitro D.Slv	C-159 Nitro D.Slv			Dia. (mm): 57mm plan	100:-	02006046	02005045	02006053
13	Nitro Aero G.Blk Beskrivning: Nitro G.Blk	C-159 Nitro G.Blk			Dia. (mm): 57mm plan	100:-	02006048	02005045	02006054
14	Nitro Aero G.Dark Gun Beskrivning: Nitro G.Dark Gun	C-159 Nitro G.Dark Gun			Dia. (mm): 57mm plan	100:-	02006049	02005045	02006055

* Utgår vid slut

BM Wheels



Bild	Modell	Märkning	Ytter dia. (mm)	Inner dia. (mm)	Djup (mm)	Pris Exkl.	Cap + Logo	Cap	Logo
4	BM Amiata*	C-G96	65	60	9,4	100:-	x	07005053	07006014
		Beskrivning: BM Racing Slv			Dia. (mm): 62 kvx				
2	BM Bari*	PCW3B	55	50	8	100:-	09005054	09005003	09006017
		Beskrivning: BM Racing Slv			Dia. (mm): 55 kvx				
6	BM Capri Pcd 100	XCE-030-CH			9	100:-	07005110	07005005	07006062
		Beskrivning: BM Racing Slv			Dia. (mm): 56,5 kvx				
6	BM Capri Pcd >100	C-287-C	62,2	57	9	100:-	x	07005016	07006061
		Beskrivning: BM Racing Slv			Dia. (mm): 62 kvx				
2	BM Coach	PCW3B-60	62	56,8	10,4	100:-	09005065	09005038	09006053
		Beskrivning: BM Racing Slv			Dia. (mm): 65 kvx				
2	BM Cortina*	PCW3B	55	50	8,4	100:-	09005046	09005003	09006005
		Beskrivning: BM Racing Slv			Dia. (mm): 55 kvx				
9	BM Drive Pcd 100	C-030-GM6				100:-	07005139	07005140	07006037
		Beskrivning: BM Wheels GM6			Dia. (mm): 56,5 kvx				
9	BM Drive	C-287-GM6				100:-	07005137	07005138	07006036
		Beskrivning: BM Wheels GM6			Dia. (mm): 62 kvx				
9	BM Drive M.Gun Pcd 100	C-030-MB				100:-	07005107	07005108	07006060
		Beskrivning: BM Wheels M.Blk			Dia. (mm): 56,5 kvx				
9	BM Drive M.Gun	C-287-MB	62,2	57	9	100:-	07005116	07005106	07006065
		Beskrivning: BM Wheels M.Blk			Dia. (mm): 62 kvx				
10	BM Escape (5-108)	VV-05	62,2	56,5	15,6	100:-	02005012	02005011	02006040
		Beskrivning: BM Racing Slv			Dia. (mm): 63 kvx				
10	BM Escape (5-112/114)	C-284-1	55	48,4	7,8	100:-	02005050	02005002	02006013
		Beskrivning: BM Racing Slv			Dia. (mm): 60 plan				
10	BM Escape Pcd >5-114	C-043	67	60	12	100:-	02005052	02005009	02006007
		Beskrivning: BM Racing Slv			Dia. (mm): 62 plan				
1	BM Forno*	Red C-E37	60	54,5	14	100:-	x	07005037	07006056
		Black C-E37	60	54,5	14	100:-	x	07005036	07006056
		Chrome C-E37	60	54,5	14	100:-	x	07005070	07006056
		Beskrivning: BM Racing Slv			Dia. (mm): 50 plan				
5	BM Genesis*	PC-287-4	62,2	57	12,2	100:-	x	07005033	x
		Beskrivning: BM Racing Slv			Dia. (mm): 60 plan				
3	BM Hawk Pcd 100*	PCW3B-60	55	50	10,4	100:-	09005046	09005003	09006005
		Beskrivning: BM Racing Slv			Dia. (mm): 55 kvx				
3	BM Hawk Pcd >100*	PCW3B-60	62	56,8	10,4	100:-	09005053	09005038	09006018
		Beskrivning: BM Racing Slv			Dia. (mm): 65 kvx				
8	BM Macho	PCW3B-60	62	56	10,5	100:-	09005032	09005038	09006031
		Beskrivning: BM Wheels Slv			Dia. (mm): 65 kvx				
9	BM Macho M.Blk	PCW3B-60 FB	62	56	10,5	100:-	09005034	09005025	09006032
		Beskrivning: BM Wheels Blk			Dia. (mm): 65 kvx				
9	BM Power	C-284-1	55	48,4	7,8	100:-	02005095	02005002	02006046
		Beskrivning: BM Wheels Slv			Dia. (mm): 60 plan				

* Utgår vid slut

BM Wheels

Bild	Modell	Märkning	Ytter dia. (mm)	Inner dia. (mm)	Djup (mm)	Pris Exkl.	Cap + Logo	Cap	Logo
8	BM Raven	C-287-C Beskrivning: BM Wheels Slv	62,2	57	9 Dia. (mm): 62 kvx	100:-	07005115	07005016	07006064
9	BM Raven G.Blk	C-287-C MB Beskrivning: BM Wheels M.Blk	62,2	57	9 Dia. (mm): 62 kvx	100:-	07005116	07005106	07006065
10	BM Sector	C-043 Beskrivning: BM Racing Slv	67	60	12 Dia. (mm): 62 plan	100:-	02005052	02005009	02006007
10	BM Sector (5-108)	VV-05 Beskrivning: BM Racing Slv	62,2	56,5	15,6 Dia. (mm): 63 kvx	100:-	02005012	02005011	02006040
8	BM Split	PCW 3B Beskrivning: BM Wheels Slv	55	50	8,4 Dia. (mm): 55 kvx	100:-	09005067	09005003	09006054
7	BM Shadow	C-287-MB Beskrivning: BM Racing M.Blk	62,2	57	9 Dia. (mm): 62 kvx	100:-	07005105	07005106	07006059
6	BM Tornado Pcd 100	XCE-030-CH Beskrivning: BM Racing Slv			9 Dia. (mm):	100:-	07005110	07005005	07006062
6	BM Tornado Pcd >100	C-287-C Beskrivning: BM Racing Slv	62,2	57	9 Dia. (mm): 62 kvx	100:-	07005109	07005016	07006061

* Utgår vid slut

Team Dynamics



Bild	Modell	Märkning	Ytter dia. (mm)	Inner dia. (mm)	Djup (mm)	Pris Exkl.	Cap + Logo	Cap	Logo
1	TD Le Mans*	H110	59	55,7	5,8	160:-	01005056	x	x
2	TD Monza Carbon*	LC72C Beskrivning: Team Dynamics Slv	153 total	45,3	60 kvx Dia. (mm):	160:-	01005057	x	01006013
3	TD Smartie/Highway/RvR II*	H60 Beskrivning: Team Dynamics Slv	55,5	50,8	11 Dia. (mm): 60 plan	100:-	x	01005029	01006011
4	Cap TD Equinox/Mesh 3*	H067	54,5	48,6	6	100:-	01005052	x	x
5	Cap Balmoral*	H117-BAL			Dia. (mm):	100:-	01005058	x	x

* Utgår vid slut

Ballistic, Incubus & PCW



Bild	Modell	Märkning	Ytter dia. (mm)	Inner dia. (mm)	Djup (mm)	Pris Exkl.	Cap + Logo	Cap	Logo
6	Ballistic Anvil	WXORGB				480:-	09005018	09005019	09006037
					Dia. (mm): 65,3 kvx				
8	Ballistic Dakota	Cap OR-VD FB				480:-	09005008	x	x
					Dia. (mm):				
9	Ballistic Dakota Blk.Pol	CAP OR-VD GB				480:-	09005010	x	x
					Dia. (mm):				
10	Ballistic Guillotine	Cap OR-D				480:-	09005011	x	x
					Dia. (mm): 65,3 kvx				
10	Ballistic Guillotine 8-165/170	Cap OR-3				480:-	09005009	x	x
					Dia. (mm): 65,3 kvx				
7	Ballistic Morax	WXORFB				480:-	09005020	09005021	09006037
					Dia. (mm): 65,3 kvx				
6	Ballistic Ravage	WXORGB				480:-	09005018	09005019	09006037
					Dia. (mm): 65,3 kvx				
1	INC Hunter/Hunter II/Safari	PCW-4	66,3	60,5	17	100:-	09005075	x	x
2	INC Krawler/Passion 5-114-127*	CAP WX-02				360:-	x	09005088	09006044
	Beskrivning: Incubus Blk				Dia. (mm): 52,6 kvx				
2	INC Krawler/Passion 5-135/139*	CAP WX-03	138 total	93	61 hög	360:-	x	09005089	09006045
	Beskrivning: Incubus Blk				Dia. (mm): 65 kvx				
2	INC Krawler/Passion 6-135/139*	CAP WX-04				360:-	x	09005090	09006045
	Beskrivning: Incubus Blk				Dia. (mm): 65 kvx				
2	INC Krawler/Passion 8-165/170*	CAP WX-05	168 total	127	85 hög	360:-	x	09005091	09006046
	Beskrivning: Incubus Blk				Dia. (mm): 98 kvx				
3	INC Northstar 5-139*	CAP WX-08				360:-	x	09005082	09006041
	Beskrivning: Incubus Blk				Dia. (mm): 49 kvx				
3	INC Northstar 8-165-180*	CAP WX-11				360:-	x	09005084	09006038
	Beskrivning: Incubus Blk				Dia. (mm): 65 kvx				
3	INC Northstar 6-135/139 *	CAP WX-09				360:-	x	09005085	09006041
	Beskrivning: Incubus Blk				Dia. (mm): 49 kvx				
3	INC Northstar 6-114/127*	CAP WX-13				360:-	x	09005086	09006042
	Beskrivning: Incubus Blk				Dia. (mm): 43 kvx				
5	Plastic Piece Flat Black+Rivets 17" Ballistic Morax					120:-	09005078		
5	Plastic Piece Flat Black+Rivets 18" Ballistic Morax					120:-	09005079		
5	Plastic Piece Flat Black+Rivets 20" Ballistic Morax					120:-	09005080		

* Utgår vid slut



Image



Bild	Modell	Märkning	Ytter dia. (mm)	Inner dia. (mm)	Djup (mm)	Pris Exkl.	Cap + Logo	Cap	Logo
8	Image Atlas PCD <100	PCW3B Beskrivning: Image Slv	55	50	9	100:-	09005006	09005003	09006022
8	Image Atlas PCD >100	PCW3B-60 Beskrivning: Image Slv	62	56	10,5	100:-	09005007	09005038	09006023
8	Image Atlas (Et 62)	Mercy Polos Beskrivning: Image Slv			70 plan	100:-	09005065	09005061	09006026
11	Image Atlas M.Gun PCD <100	PCW3B FSDG Beskrivning: Image Gun	54,8	50	8,4	100:-	09005069	09005068	09006035
11	Image Atlas M.Gun PCD >100	PCW3B-60 FSDG Beskrivning: Image Gun	62	56	10,5	100:-	09005036	09005070	09006034
11	Image Atlas M.Gun (Et 62)	Mercy Polos FSDG Beskrivning: Image Gun			70 plan	100:-	09005029	09005028	09006033
6	Image Arctis	C126 Beskrivning: Image Slv	150 total		59,6 plan	100:-	02005034	02005033	02006003
2	Image Avalon*	C-284-1 Beskrivning: Image Slv	55	48,4	7,8	100:-	02005001	02005002	02006003
3	Image Blade gamla*	SH004-CAP	150 total			160:-	x	09005045	09006006
3	Image Blade nya*	CAP SH004-2 Beskrivning: Image Slv	150 total		58 plan	160:-	x	09005047	09006006
	Image Brio					100:-	08005001	08005003	07006046
7	Image Carrier PCD <100	PCW3B FB Beskrivning: Image Blk	54,8	50	8,4	100:-	09005022	09005023	09006020
7	Image Carrier PCD >100	PCW3B-60 FB Beskrivning: Image Blk	62	56	10,5	100:-	09005024	09005025	09006021
7	Image Carrier (Et 62)	Mercy Polos FB Beskrivning: Image Blk			70 plan	100:-	09005064	09005062	09006025
8	Image Classic	PCW3B-60 Beskrivning: Image Slv	62	56	10,5	100:-	09005007	09005038	09006023
7	Image Colt (5-100)	C-030-GB Beskrivning: Image G.Blk			56,5 kvx	100:-	07005030	07005031	07006106
7	Image Colt	C398C-G.Blk Beskrivning: Image G.Blk			65 kvx	100:-	07005184	07005158	07006102
7	Image Colt L.Gun (5-100)	C-030-LGM Beskrivning: Image L.Gun			56,5 kvx	100:-	07005091	07005092	07006112
	Image Colt L.Gun	C398C-L.Gun Beskrivning: Image L.Gun			65 kvx	100:-	07005142	07005143	07006111
7	Image Colt SUV	C398C-G.Blk Beskrivning: Image G.Blk			65 kvx	100:-	07005184	07005158	07006102
	Image Colt SUV L.Gun	C398C-L.Gun Beskrivning: Image L.Gun			65 kvx	100:-	07005142	07005143	07006111

Image

Bild	Modell	Märkning	Ytter dia. (mm)	Inner dia. (mm)	Djup (mm)	Pris Exkl.	Cap + Logo	Cap	Logo
11	Image Comet	XC648VW Gm Beskrivning: Image G.Gun			Dia. (mm): 50 kvx	100:-	07005179	07005178	07006096
7	Image Comet G.Bik/Pol	XC648VW G.Bik Beskrivning: Image G.Bik			Dia. (mm): 50 kvx	100:-	07005208	07005209	07006110
8	Image Comet Slv.	XC648VW Beskrivning: Image Slv			Dia. (mm): 50 kvx	100:-	07005164	07005161	07006044
4	Image Davos*	CAP-SH11 Beskrivning: Image Slv	155 total		Dia. (mm): 58 plan	160:-	x	09005051	09006006
8	Image Delta PCD <100	PCW3B Beskrivning: Image Slv	54,8	50	8,4 Dia. (mm): 55 kvx	100:-	09005006	09005003	09006022
8	Image Delta PCD >100	PCW3B-60 Beskrivning: Image Slv	62	56	10,5 Dia. (mm): 65 kvx	100:-	09005007	09005038	09006023
7	Image Delta M.Bik PCD <100	PCW3B FB Beskrivning: Image Slv	54,8	50	8,4 Dia. (mm): 55 kvx	100:-	09005022	09005023	09006020
7	Image Delta M.Bik PCD >100	PCW3B-60 FB Beskrivning: Image Slv	62	56	10,5 Dia. (mm): 65 kvx	100:-	09005024	09005025	09006021
8	Image Legend	PCW3B-60 Beskrivning: Image Gun	62	56	10,5 Dia. (mm): 65 kvx	100:-	09005036	09005070	09006034
1	Image Lugano*	PCW3B Beskrivning: Image Slv	54,8	50	8,4 Dia. (mm): 55 kvx	100:-	09005042	09005003	09006004
5	Image Mist hög*	PCW-3BB Beskrivning:	55	50,7	12 Dia. (mm): 45 kvx	100:-	x	09005044	x
9	Image Motion (5-100)	XC648VW Beskrivning: Image Slv			Dia. (mm): 50 kvx	100:-	07005164	07005161	07006044
9	Image Motion (5-108)	XCVOL Beskrivning: Image Slv			Dia. (mm): 60kvx	100:-	07005013	07005014	07006045
9	Image Motion	XC647VW Beskrivning: Image Slv			Dia. (mm): 60 kvx	100:-	07005141	07005123	07006046
11	Image Motion G.Gun (5-100)	XC648VW GM Beskrivning: Image G.Gun			Dia. (mm): 50 kvx	100:-	07005179	07005178	07006096
11	Image Motion G.Gun (5-108)	XCVOL Beskrivning: Image G.Gun			Dia. (mm): 60kvx	100:-	07005180	07005175	07006095
11	Image Motion G.Gun	XC647VW Beskrivning: Image G.Gun			Dia. (mm): 60 kvx	100:-	07005181	07005176	07006083
8	Image Palermo Pcd 100/108	XCE030CH Beskrivning: Image Slv			9 Dia. (mm):	100:-	07005118	07005005	07006066
8	Image Palermo >110	C-287-C Beskrivning: Image Slv	62,2	57	9 Dia. (mm): 62 kvx	100:-	07005119	07005016	07006067
10	Image Polar	PCW3B Beskrivning: Image Slv	54,8	50	8,4 Dia. (mm): 55 kvx	100:-	09005006	09005003	09006022
8	Image Rebel (4-100)	PCW3B Beskrivning: Image Slv			Dia. (mm): 55 kvx	100:-	09005006	09005003	09006022
8	Image Rebel (4-115)	PCW3B-60 Beskrivning: Image Slv			Dia. (mm): 65 kvx	100:-	09005007	09005038	09006023
7	Image Rebel M.Bik (4-100)	PCW3B FB Beskrivning: Image Bik			Dia. (mm): 55 kvx	100:-	09005022	09005023	09006020
7	Image Rebel M.Bik (4-115)	PCW3B-60 FB Beskrivning: Image Bik			Dia. (mm): 65 kvx	100:-	09005024	09005025	09006021
9	Image Ride	XC566VW Beskrivning: Image Slv			Dia. (mm): 60 kvx	100:-	07005019	07005127	07006046
	Image Ride Bik/Pol	XC566VW-GB Beskrivning: Image G.Bik			Dia. (mm): 60 kvx	100:-	07005021	07005128	07006084
9	Image Ride HL	XCB87 Beskrivning: Image Slv			Dia. (mm): 62 kvx	100:-	07005022	07005002	07006067
12	Image Ride HL M.Gun	XCB87-GM Beskrivning: Image G.Gun			Dia. (mm): 62 kvx	100:-	07005025	07005027	07006007
	Image Ride HL Bik/Pol	XCB87-GB Beskrivning: Image G.Bik			Dia. (mm): 62 kvx	100:-	07005025	07005027	07006007
	Image Rock	PCW3B DG Beskrivning: Image Gun	54,8	50	8,4 Dia. (mm): 55 kvx	100:-	09005014	09005013	09006035
	Image Rock 6-114	Beskrivning: Image Gun			Dia. (mm):	100:-	09005016	x	x

Image

Bild	Modell	Märkning	Ytter dia. (mm)	Inner dia. (mm)	Djup (mm)	Pris Exkl.	Cap + Logo	Cap	Logo
	Image Rock G.Blk	PCW3B DG Beskrivning: Image Gun	54,8	50	8,4 Dia. (mm): 55 kvx	100:-	09005127	09005126	09006016
	Image Rock 6-114 G.Blk	M-2P Beskrivning: Image Gun			Dia. (mm):	100:-	09005026	x	x
	Image Solid	PCW3B DG Beskrivning: Image Gun	54,8	50	8,4 Dia. (mm): 55 kvx	100:-	09005014	09005013	09006035
	Image Solid Gun/Pol	PCW3B DG Beskrivning: Image Gun	54,8	50	8,4 Dia. (mm): 55 kvx	100:-	09005014	09005013	09006035
	Image Star FF G.Blk/Pol	C073A-G.Blk Beskrivning: Image G.Blk			Dia. (mm): 65 kvx	100:-	07005090	07005156	07006102
	Image Star FF L.Gun	C073A-L.Gun Beskrivning: Image L.Gun			Dia. (mm): 65 kvx	100:-	07005087	07005086	07006011
	Image Star FF Slv	C073A Beskrivning: Image Slv			Dia. (mm): 65 kvx	100:-	07005088	07005081	07006100
8	Image Stella	Beskrivning: Image Slv			Dia. (mm):	100:-	09005123	x	x
7	Image Stella Blk	Beskrivning: Image Blk			Dia. (mm):	100:-	09005125	x	x
13	Image Strong <120	C398C Beskrivning: Image Slv			Dia. (mm): 65 kvx	100:-	07005182	07005034	07006100
13	Image Strong >130	TR36-C Beskrivning: Image Slv			Dia. (mm): 76,8 plan	100:-	07005186	07005185	07006103
13	Image Strong G.Blk <120	C398C-G.Blk Beskrivning: Image G.Blk			Dia. (mm): 65 kvx	100:-	07005184	07005158	07006102
13	Image Strong G.Blk >130	TR36-C-G.Blk Beskrivning: Image G.Blk			Dia. (mm): 76,8 plan	100:-	07005188	07005185	07006105
14	Image Strong M.Gun <120	C398-MGM6 Beskrivning: Image MGM			Dia. (mm): 65 kvx	100:-	07005183	07005114	07006101
14	Image Strong M.Gun >130	TR36-C Beskrivning: Image MGM			Dia. (mm): 76,8 plan	100:-	07005187	07005185	07006104
	Image Thor	Beskrivning:			Dia. (mm):	100:-	x	08005002	
1	Image Torino PCD>100	XCF56-C Beskrivning: Image Slv	54,8	50	7,8 Dia. (mm): 60 plan	100:-	07005111	07005068	07006063
1	Image Torino PCD 100	PCF86-C Beskrivning: Image Slv	56,5	51	9 Dia. (mm): 60 plan	100:-	07005112	07005069	07006063
2	Image Twist	C-284-1 Beskrivning: Image Slv	55	48,4	7,8 Dia. (mm): 60 plan	100:-	02005001	02005002	02006003
11	Image Vector (5-098/108)	XC647VW2 Beskrivning: Image G.Gun			Dia. (mm): 50 kvx	100:-	07005179	07005178	07006096
11	Image Vector	XC647VW Beskrivning: Image G.Gun			Dia. (mm): 60 kvx	100:-	07005181	07005176	07006083
	Image Vector G.Blk (5-108)	XC648VW G.Blk Beskrivning: Image G.Blk			Dia. (mm): 50 plan	100:-	07005208	07005209	07006110
	Image Vector G.Blk/Pol	XC647VW G.Blk Beskrivning: Image G.Blk			Dia. (mm): 60 kvx	100:-	07005210	07005207	07006084
9	Image Vector Slv (5-108)	XC647VW2 Beskrivning: Image Slv			Dia. (mm): 50 kvx	100:-	07005164	07005161	07006044
9	Image Vector Slv	XC647VW Beskrivning: Image Slv			Dia. (mm): 60 kvx	100:-	07005141	07005123	07006046
1	Image Wind*	PCW3B Beskrivning: Image Slv	54,8	50	8,4 Dia. (mm): 55 kvx	100:-	09005042	09005003	09006004

* Utgår vid slut

Breyton / TSW / MSW



Bild	Modell	Märkning	Ytter dia. (mm)	Inner dia. (mm)	Djup (mm)	Pris Exkl.	Cap+Logo
1	Breyton GTR/GTSR/LS Slv	C-G96	65	60	9,4	250:-	06005007
	Beskrivning:				Dia. (mm): 62 kvx		
2	Breyton GTR/GTSR/LS Blk	C-G96	65	60	9,4	250:-	06005008
	Beskrivning:				Dia. (mm): 62 kvx		
3	Breyton GTS/GTSR Gun	C-G96	65	60	9,4	250:-	06005009
	Beskrivning:				Dia. (mm): 62 kvx		
1	Breyton Race GTP Slv	PC997	65	59,8	10	250:-	06005010
	Beskrivning:				Dia. (mm): 65 plan		
2	Breyton GTP Blk	PC997	65	59,8	10	250:-	06005011
	Beskrivning:				Dia. (mm): 65 plan		
3	Breyton GTP Gun	PC997	65	59,8	10	250:-	06005012
	Beskrivning:				Dia. (mm): 65 plan		
1	Breyton Race GTS Slv	C-G96	65	60	9,4	250:-	06005013
	Beskrivning:				Dia. (mm): 62 kvx		
6	TSW USA 60	C-F80	60	55,2	7,8	200:-	04005103
	Beskrivning:				Dia. (mm): 70 plan		
7	Beyern	C-C43	66,2	62	12	200:-	04005101
	Beskrivning:				Dia. (mm): 57 plan		
8	Mandrus	C-E71	69	65,4	17	200:-	04005102
	Beskrivning:				Dia. (mm): 63,5 kvx		
9	Victor Equipment	C-E76	60	55	14,3	200:-	04005114
	Beskrivning:				Dia. (mm):		
10	Breyton GTS-AV M.Black / 5-112			70		200:-	06005014
	Beskrivning:				Dia. (mm):		
11	Breyton GTS-AV M. Gun / 5-112			70		200:-	06005015
	Beskrivning:				Dia. (mm):		
12	Breyton GTS-AV Silver / 5-112			70		200:-	06005016
	Beskrivning:				Dia. (mm):		
10	Breyton GTS-AV M.Black / 5-100			60		200:-	06005017
	Beskrivning:				Dia. (mm):		
11	Breyton GTS-AV M. Gun / 5-100			60		200:-	06005018
	Beskrivning:				Dia. (mm):		
12	Breyton GTS-AV Silver / 5-100			60		200:-	06005019
	Beskrivning:				Dia. (mm):		

För Cap och Logo till OZ och MSW, fråga oss!

* Utgår vid slut

ATS



Bild	Modell	Märkning	Ytter dia. (mm)	Inner dia. (mm)	Djup (mm)	Pris Exkl.	Cap+Logo
1	ATS Antares 6,0x15	N23				200:-	02005109
	Beskrivning:				Dia. (mm):		
1	ATS Antares VW	N50				200:-	02005110
	Beskrivning:				Dia. (mm):		
1	ATS Antares Audi	N55				200:-	02005111
	Beskrivning:				Dia. (mm):		
2	ATS Antares G.Blk 6,0x15	N23				200:-	02005106
	Beskrivning:				Dia. (mm):		
2	ATS Antares G.Blk VW	N50				200:-	02005107
	Beskrivning:				Dia. (mm):		
2	ATS Antares G.Blk Audi	N55				200:-	02005108
	Beskrivning:				Dia. (mm):		
3	ATS Evolution 5-112	N54				200:-	02005104
	Beskrivning:				Dia. (mm):		
3	ATS Evolution 5-112	N37				200:-	02005105
	Beskrivning:				Dia. (mm):		
4	ATS Evolution G.Grey 5-112	N54				200:-	02005102
	Beskrivning:				Dia. (mm):		
4	ATS Evolution G.Grey 5-120	N37				200:-	02005103
	Beskrivning:				Dia. (mm):		
5	ATS Mizar	N12				200:-	02005101
	Beskrivning:				Dia. (mm):		
6	ATS Mizar G.Blk	N12				200:-	02005100
	Beskrivning:				Dia. (mm):		

4X4

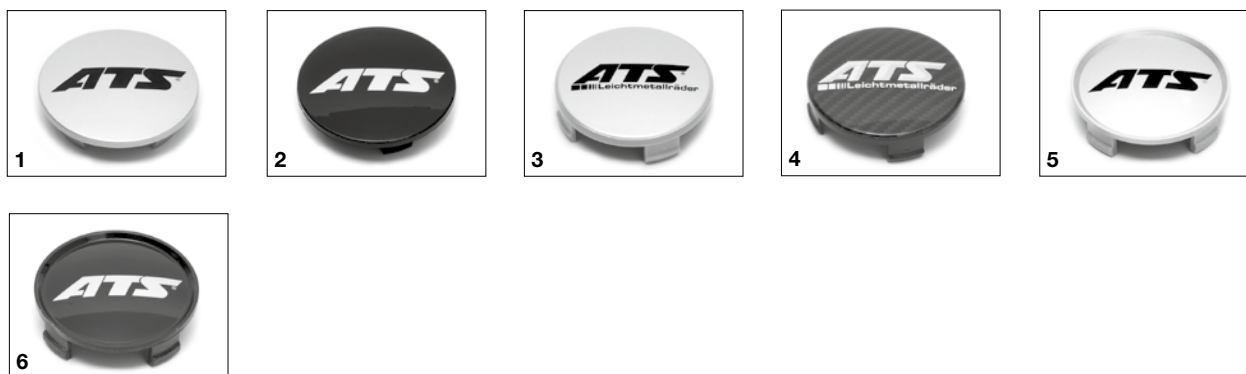

Bild	Artikelnr	Modell	Ytter dia. (mm)	Höjd (mm)	Material	Pris Exkl.
4	03005003*	Cap Stängd	84	85		100:-
2	03005022*	Cap Öppen	108	70		100:-
2	03005009*	Cap Öppen	108	112	Rostfri	100:-
1	03005014*	Cap Öppen	130	110	Rostfri	120:-
3	03005020*	Cap Öppen	108	70	Snap-on inkl. lock	120:-
	03005021*	Lock till Snap-on				48:-

* Utgår vid slut



Bild	Art.nr	Benämning	PCD	CB Fälg (mm)	CB Nav (mm)	Pris/st exkl.	
1	050090041	Universalspacer 3 mm	4/5 Universal		78	60:-	
1	050090051	Universalspacer 5 mm	4/5 Universal		75	80:-	
1	050090031	Universalspacer 10 mm	4/5 Universal		75	100:-	
2	05009014	Universalspacer 10 mm	5/6-139,7		110	160:-	
3	05009007	Universalspacer 6 mm	8-165,1		126	80:-	
5	05009032	Spacer 5 mm	4/5-100		54,1	240:-	
5	05009033	Spacer 5 mm	4/5-100		57,1	240:-	
5	05009034	Spacer 5 mm	4/5-108		63,3	240:-	
5	05009035	Spacer 5 mm	4/5-108		65,1	240:-	
5	05009036	Spacer 5 mm	5-100/112		57,1	240:-	
5	05009037	Spacer 5 mm	4/5-114,3		67,1	240:-	
		Audi/Seat/Skoda/VW					
9	05009015	Spacer 8 mm	4/5-100	73,1	57,1	360:-	
8	05009044	Spacer 15 mm	5-112	57,1	57,1	360:-	
8	05009045	Spacer 20 mm	5-112	57,1	57,1	360:-	
8	05009046	Spacer 25 mm	5-112	57,1	57,1	360:-	
		Audi/MB/Seat/Skoda/VW					
10	05009024	Spacer 8 mm	5-100/112	72,2	66,6	360:-	
10	05009025	Spacer 8 mm	5-100/112	73,1	66,6	360:-	
5	05009043	Spacer 10 mm	5-100/112		66,6	360:-	
10	05009031	Spacer 15 mm	5-100/112	72,2	66,6	360:-	
10	05009030	Spacer 15 mm	5-100/112	73,1	66,6	360:-	
		(Vänligen beställ c-ring 666571 till Audi/VW)					
		Audi/MB					
8	05009047	Spacer 20 mm	5-112	66,5	66,5	360:-	
		BMW					
8	05009028	Spacer 5 mm	5-120	74,1	72,5	360:-	
5	05009038	Spacer 5 mm	5-120	72,5	72,5	360:-	
5	05009039	Spacer 5 mm	5-120	74,1	74,1	360:-	
8	05009026	Spacer 10 mm	5-120	74,1	72,5	360:-	
5	05009058	Spacer 10 mm	5-120	72,5	72,5	360:-	
8	05009029	Spacer 15 mm	5-120	74,1	72,5	360:-	
8	05009060	Spacer 15 mm	5-120	72,5	72,5	360:-	
8	05009063	Spacer 15 mm	5-120	72,5	74,1	360:-	
8	05009048	Spacer 18 mm	5-120	72,5	72,5	360:-	
8	05009042	Spacer 20 mm	5-120	72,5	72,5	360:-	
8	05009019	Spacer 20 mm	5-120	72,5	74,1	360:-	
8	05009061	Spacer 20 mm	5-120	74,1	74,1	360:-	
8	05009064	Spacer 20 mm	5-120	74,1	72,5	360:-	
		(I.ex. 3-seriens fälgar kan monteras på en 5-serie)					
		Breyton Spacer. Säljes endast parvis, priset avser 2 st spacer.					
5	06009001	Breyton Spacer 5 mm	5-120	72,5	72,5	1200:-	
5	06009002	Breyton Spacer 5 mm	5-120	74,1	74,1	1200:-	
8	06009006	Breyton Spacer 10 mm	5-120	74,1	74,1	1500:-	
8	06009008	Breyton Spacer 10 mm	5-120	72,5	74,1	1500:-	
8	06009011	Breyton Spacer 15 mm	5-120	74,1	72,5	1700:-	
8	06009012	Breyton Spacer 15 mm	5-120	72,5	74,1	1700:-	
8	06009016	Breyton Spacer 20 mm	5-120	72,5	74,1	1800:-	
8	06009021	Breyton Spacer 11 mm	5-112	66,56	66,56	1500:-	
8	06009022	Breyton Spacer 15 mm	5-112	66,56	66,56	1700:-	
8	06009023	Breyton Spacer 20 mm	5-112	66,56	66,56	1800:-	
8	06009024	Breyton Spacer 10 mm	5-112	66,56	57,1	1500:-	
		06009025	Breyton Spacer 15 mm	5-112	66,56	57,1	1700:-
		06009026	Breyton Spacer 20 mm	5-112	66,56	57,1	1800:-
		Fiat/Renault					
9	05009096	Spacer 8 mm	5-118	73,1	71,1	360:-	
		Peugeot/Saab/Volvo					
9	05009016	Spacer 5 mm	4/5-108	73,1	65,1	360:-	
9	05009018	Spacer 8 mm	4/5-108	73,1	65,1	360:-	
9	05009023	Spacer 15 mm	4/5-108	72,2	65,1	360:-	
9	05009017	Spacer 20 mm	4/5-108	73,1	65,1	360:-	
		Porsche/Vw					
5	05009051	Spacer 7 mm	5-130	71,6	71,6	360:-	
9	05009095	Spacer 8 mm	5-120	73,1	65,1	360:-	
		Saab/Peugeot					
9	05009049	Spacer 20 mm	4/5-108	65,1	65,1	360:-	
8	05009050	Spacer 20 mm	5-110	65,1	65,1	360:-	
		Nissan					
10	05009093	Spacer 6 mm	6-114,3	66,1	83,7	360:-	
		Volvo					
7	05009027	Spacer 25 mm	5-108	65,1	65,1	960:-	
5	05009041	Spacer 10 mm	5-108		65,1	360:-	

CB kommer av CenterBore och anger fälgens centrumhål i mm

* = Utgår vid slut.



Bild	Art.nr	Gänga	Längd/ Höjd	Kona	Skalle	Övrigt	Pris Exkl
Mutter							
1	05001160	7/16"	17	60°	19	Öppen	16:-
	05001260	1/2"	17	60°	19	Öppen	12:-
	05001560	12x1,25	17	60°	19	Öppen	12:-
	05001660	12x1,50	17	60°	19	Öppen	12:-
	05001860	14x1,50	17	60°	19	Öppen	16:-
2	05001661	12x1,50	18	R12	17	Öppen	16:-
3	05001260-1	1/2"	25	60°	19	Öppen	12:-
	05001260-2	1/2"	23	60°	17	Öppen	16:-
	05001360-1	9/16"	25	60°	21	Öppen	16:-
	05001560-1	12x1,25	25	60°	19	Öppen	12:-
	05001660-1	12x1,50	25	60°	19	Öppen	12:-
	05001660-2	12x1,50	25	60°	21	Öppen	16:-
	05001860-1	14x1,50	25	60°	19	Öppen	12:-
	05001960	14x2	25	60°	19	Öppen	16:-
4	05001069	10x1,25	23	60°	19	Kupol	16:-
	05001070	10x1,50	23	60°	19	Kupol	16:-
	05001574	12x1,25	30	60°	19	Kupol	16:-
	05001674	12x1,50	30	60°	19	Kupol	16:-
	05001874	14x1,50	30	60°	19	Kupol	16:-
5	05001170	7/16"	34	60°	19	Kupol	12:-
	05001270	1/2"	34	60°	19	Kupol	12:-
	05001570	12x1,25	34	60°	19	Kupol	12:-
	05001570-1	12x1,25	34	60°	17	Kupol	16:-
	05001670	12x1,50	34	60°	19	Kupol	12:-
	05001670-1	12x1,50	34	60°	17	Kupol	16:-
6	05001271	1/2"	37	60°	21	Kupol	16:-
	05001275	1/2"	34	60°	21	Kupol	16:-
	05001673	12x1,50	34	60°	21	Kupol	16:-
	05001873	14x1,50	34	60°	19	Kupol	16:-
Bult							
13	05002520-1	12x1,25	26	60°	17	7 mm skallhöjd	28:-*
	05002620-1	12x1,50	27	60°	17	7 mm skallhöjd	28:-
	05002920-1	14x1,25	24	60°	17	7 mm skallhöjd	28:-
	05002810-1	14x1,50	20	60°	17	7 mm skallhöjd	28:-
	05002820-1	14x1,50	26	60°	17	7 mm skallhöjd	28:-
14	05002510	12x1,25	24	60°	17		16:-
	05002530	12x1,25	28	60°	17		16:-
	05002540	12x1,25	30	60°	17		16:-
	05002540-1	12x1,25	30	60°	19	Utgår vid slut	16:-
	05002550	12x1,25	36	60°	17		28:-
	05002560	12x1,25	42	60°	17		32:-
	05002560-1	12x1,25	42	60°	19	Utgår vid slut	32:-
	05002580	12x1,25	50	60°	17		32:-
	05002590	12x1,25	60	60°	17		32:-
	05002600	12x1,50	22	60°	17		16:-
	05002610-1	12x1,50	21	60°	17		28:-
	05002610	12x1,50	24	60°	17		16:-
	05002620	12x1,50	26	60°	17		16:-
	05002640	12x1,50	32	60°	17		28:-
	05002650	12x1,50	35	60°	17		28:-
	05002660	12x1,50	39	60°	17		32:-
	05002670	12x1,50	45	60°	17		32:-
	05002680	12x1,50	50	60°	17		32:-
	05002690	12x1,50	55	60°	17		32:-
	05002720	12x1,75	27	60°	19		16:-
	05002750	12x1,75	35	60°	19		16:-
	05002820	14x1,50	25	60°	17		16:-
	05002830	14x1,50	28	60°	17		16:-
	05002840	14x1,50	30	60°	17		16:-
	05002840-2	14x1,50	30	60°	19		40:-
	05002850	14x1,50	33	60°	17		16:-
	05002860	14x1,50	40	60°	17		32:-
	05002870	14x1,50	45	60°	17		32:-
	05002880	14x1,50	50	60°	17		32:-
	05002890	14x1,50	60	60°	17		32:-

Bild	Art.nr	Gänga	Längd/ Höjd	Kona	Skalle	Övrigt	Pris Exkl
Mutter							
7	05001671	12x1,50	27	R12	19	Kupol	16:-
	05001871	14x1,50	27	R12	19	Kupol	16:-
8	05001200	1/2"	29	60°	19	15,7x6 /Öppen	28:-
	05001210	1/2"	34	60°	19	15,7x6 mm	28:-
	05001300	9/16"	29	60°	19	15,7x6 /Öppen	28:-
	05001510	12x1,25	34	60°	19	15,7x6 mm	28:-
	05001610	12x1,50	34	60°	19	15,7x6 mm	28:-
	05001600	12x1,50	29	60°	19	15,7x6 /Öppen	28:-
	05001800	14x1,50	29	60°	19	15,7x6 /Öppen	28:-
	05001810	14x1,50	34	60°	19	15,7x6	28:-
9	05001220	1/2"	38,5	60°	19	17,2x14,5 mm	28:-
	05001520-1	12x1,25	38,5	60°	19	17,2x12 mm	28:-
	05001620-1	12x1,50	38,5	60°	19	17,2x12 mm	28:-
	05001820	14x1,50	38,5	60°	19	17,2x14,5 mm	28:-
10	05001770	12x1,75	41	60°	19	Kupol	16:-
	05001870	14x1,50	41	60°	19	Kupol	16:-
	05001980	14x2	41	60°	19	Kupol	16:-
11	05001280	1/2"	49	60°	21	Kupol	60:-
	05001380	9/16"	49	60°	21	Kupol	60:-
	05001880	14x1,50	49	60°	21	Kupol	60:-
12	05001383	9/16"	60	60°	22	Kupol	60:-
	05001384	9/16"	75	60°	22	Kupol	60:-
	05001970	14x2	60	60°	22	Kupol	60:-



Bild	Art.nr	Gänga	Längd/ Höjd	Kona	Skalle	Övrigt	Pris Exkl
Bult							
14	05002927	14x1,25	27	60°	17		16:-
	05002933	14x1,25	33	60°	17		32:-
	05002940	14x1,25	40	60°	17		32:-
	05002945	14x1,25	45	60°	17		32:-
	05002950	14x1,25	50	60°	17		32:-
	05002955	14x1,25	55	60°	17		32:-
	05003033	16x1,50	33	60°	19		32:-
	05001130	7/16"	30	60°	17		60:-
15	05002601	12x1,50	21	R12	17		16:-
	05002611	12x1,50	23	R12	17		16:-
	05002621	12x1,50	28	R12	17		16:-
	05002641	12x1,50	32	R12	17		16:-
	05002651	12x1,50	35	R12	17		28:-
	05002661	12x1,50	40	R12	17		32:-
	05002671	12x1,50	45	R12	17		32:-
	05002681	12x1,50	50	R12	17		32:-
	05002821	14x1,50	27	R12	17		16:-
	05002831	14x1,50	30	R11	17		28:-
	05002841	14x1,50	30	R12	17		16:-
	05002851	14x1,50	35	R12	17		28:-
	05002861	14x1,50	40	R12	17		32:-
	05002871	14x1,50	45	R12	17		32:-
	05002881	14x1,50	50	R12	17		32:-
	05002891	14x1,50	60	R12	17		32:-
	05002931	14x1,25	30	R12	17		32:-
	05002941	14x1,25	39	R12	17		32:-
	05002934	14x1,25	29	R14	17		48:-

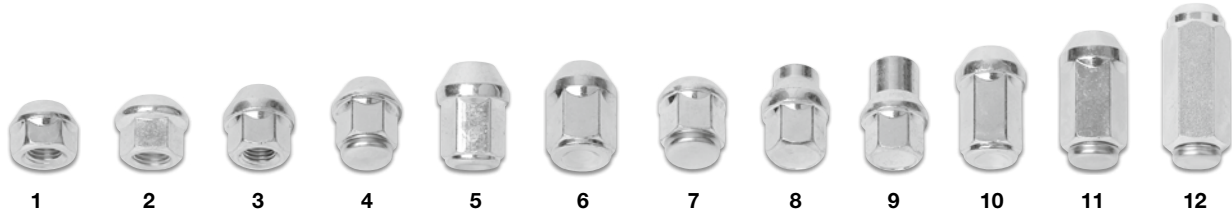





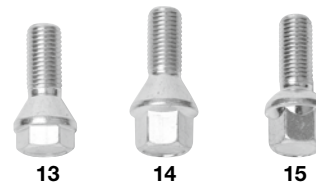
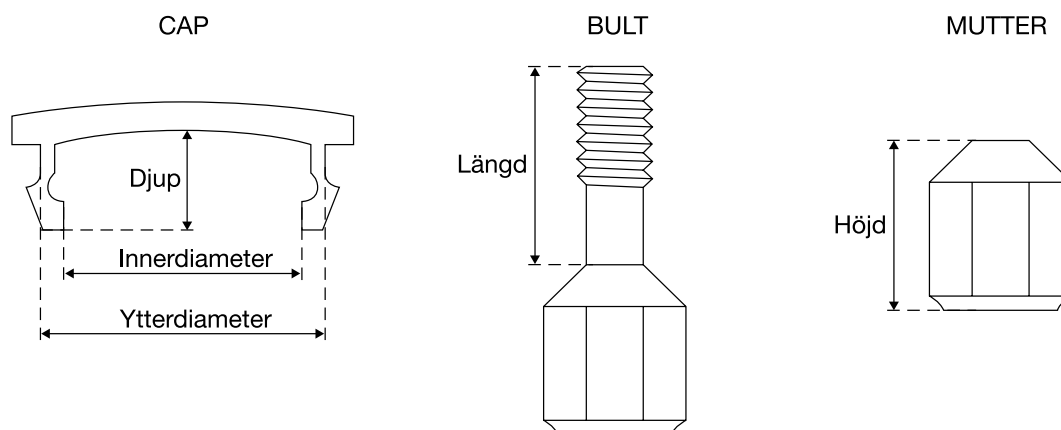

Bild	Art.nr	Gänga	Längd/ Höjd	Kona	Skalle	Övrigt	Pris Exkl	Bild	Art.nr	Gänga	Längd/ Höjd	Kona	Skalle	Övrigt	Pris Exkl
Mutter								Mutter							
1	05007007	M18x1,50	10	planbricka	32	Stängd	320:-	4	05007016	14x1,50	15	Plan	19	Öppen	40:-
	05007000	M20x1,50	10	planbricka	32	Stängd	320:-	5	05007017	16x1,50	17	Plan	22	Öppen	40:-
	05007001	22x1,50	39	planbricka	32	Öppen	160:-	6	05007018	18x1,50	18	Plan	24	Öppen	40:-
	05007003	7/8" UNF	39	planbricka	32	Öppen	160:-		05007019	20x1,50	20	Plan	27	Öppen	40:-
	05007005	7/8" BSF	39	planbricka	32	Öppen	160:-		05007020	22x1,50	22	Plan	30	Öppen	40:-
2	05007008	M18x1,50	27	planbricka		Stängd	360:-	7	05007021	14x1,50	20	R14	19	Öppen	40:-
	05007009	M20x1,50	27	planbricka		Stängd	360:-	8	05007022	16x1,50	26	R16	24	Öppen	40:-
	05007002	22x1,5	61	planbricka	32	Öppen	200:-	9	05007023	18x1,50	25	R16	24	Öppen	40:-
	05007004	7/8" UNF	61	planbricka	32	Öppen	200:-		05007024	20x1,50	27	R18	27	Öppen	40:-
	05007006	7/8" BSF	61	planbricka	32	Öppen	200:-		05007025	22x1,50	30	R18	30	Öppen	40:-
3	05007010	18x1,50	25	planbricka	27	Öppen	64:-	12	050079101	Wheel cleaning kit Xlite					1200:-
	05007011	20x1,50	27	planbricka	30	Öppen	64:-		050079102	Wheel cleaner Xlite					480:-
	05007012	22x1,50	27	planbricka	32	Öppen	64:-		050079103	Wheel polish Xlite					480:-
	05007013	22x1,50	33	planbricka	31	Öppen	64:-		05007100	Xlite Apply/Remover Plier					240:-
	05007014	7/8" BSF	30	planbricka	33	Öppen	64:-	13	050079104	Lose Nut Indicator 32mm Yellow					20:-
	05007015	7/8" UNF	30	planbricka	33	Öppen	64:-		050079105	Lose Nut Indicator 33mm Yellow					20:-
10	05007101	Wheel nut cover (Plastic)	32/33 mm				64:-		050079100	Flange wear guide					100:-
	05007102	Wheel nut cover Chromed	32 mm				48:-								
	05007103	Wheel nut cover Chromed	33 mm				48:-								
	05007104	Wheel nut cover Stainless Steel	32 mm				48:-								
	05007105	Wheel nut cover Stainless Steel	33 mm				48:-								
11	05007901	Ventil Xlite TR543C					160:-								
	05007902	Ventil Xlite 70MS/TM1670					160:-								
	05007903	Ventil Xlite TR542C					160:-								

SÅ HÄR MÄTER VI:









Bilmärke/bilmodell	Ersätter OEM art.nr.	Gänga	Gänglängd/ totallängd (mm)	Kona	Skalle	Kvalitet/ material	Passar fälgtyp	Art.nr.	Pris Exkl
ALFA ROMEO									
 147, 156, 166, GT, MITO	132 304 25	12x1,25	22/48,5	Kona 60°	17	8.8 Dacromet	Stål och aluminium	05002516	40:-
 159 09.05-, Brera 01.06-, Spider 08.06-	606 974 42 606 941 02	14x1,50	25/51	Kona 60°	17	10.9 Geomet	Stål och aluminium	05002826	40:-
AUDI									
 TT, A2, A3, A4, A6, A8, 100, 200, V8	8D0 601 139 D	14x1,50	27/47,5	Radius R13	17	10.9 White Zincplated	Stål och aluminium	05002828	40:-
 A6 (V8) Quattro, A8 (V8) Quattro, TT Quattro: S6, S8	4D0 601 139A	14x1,50	27/51	Radius R13	17	8.8 Black Zincplated	Aluminium	05002829	40:-
 A5 (B8, B9), S5 (B8, B9), RS5 A6 (4F, 4G, F2), S6, RS6 A7 (4G, F2), TT (8N, 8J, 8S)	4D0 601 139 A	14x1,50	27/51	Radius R13	17	8.8 White Zincplated 2 pcs	Aluminium	05002829	40:-
 Q3 (8U, F3), Q5 (8R, FY) Q7 (4M), Q8 (4M)	8R0 601 295	14x1,50	30/59,5	Radius R14	17	10.9 Delta- protekt KL100 2 pcs	Stål och aluminium	05002846	80:-
 Audi Q7 12.05-	7L0 601 139 A	14x1,50	37/67	Radius R14	19	10.9 White Zincplated	Aluminium	05002837	80:-
BMW									
 1-serie E82, E87, E88, 3-serie E90, E91, E92, E93, 5-serie E60, E61, 6-serie E63, E64, 7-serie E32, E38, Z3 E85, Z4 E89	36 13 1 126 191 36 13 6 781 150	12x1,50	26/51	Kona 60°	17	10.9 Black Zincplated	Stål och aluminium	05002622	40:-
 BMW X5 E53	36 13 6 756 298	14x1,50	32/44/58	Kona 60°	17	10.9 Black Zincplated	Aluminium	05002844	40:-



Bilmärke/bilmodell	Ersätter OEM art.nr.	Gänga	Gänglängd/ totallängd (mm)	Kona	Skalle	Kvalitet/ material	Passar fälgtyp	Art.nr.	Pris Exkl
BMW									
 BMW 1-serie F20,F21 2-serie F22,F23,F45,F46 3-serie F30,F31,F34,F35 / X F25 4-serie F32,F33,F36 / X F26 5-serie F10,F11,F18,F07 / X E70,F15,F85 6-serie F06,F12,F13 / X E71,E72,F16 7-serie F01,F02,F03,F04,G11,G12	36 13 6781 151	14x1,25	27/48	Kona 60°	17	8.8 Black Zincplated	Aluminium	05002923	40:-
Bild saknas i3 19-, i8 19- X5 (G05), X6 (G06), X7 (G07) 7-serie (G11, G12) 05.19-	36 13 6 795 153	14x1,25	28/54	Kona 60°	17	10.9	Aluminium Corrolube	05002928	80:-
CITROËN									
 Berlingo 09.96-04.08, Berlingo 05.08-05.18, C2, C3, C4, C5, C6, C4 Picasso, Cactus DS3, DS4, DS5, DS7 Jumpy 01.06-05.16	5405.67	12x1,25	17/57	Bricka	17	10.9 Geomet	Aluminium	05002517	40:-
 C4 Grand Picasso,Cactus 11.06-08.13, C5	5405.72	12x1,25	26/49	Kona 60°	17	10.9 Geomet	Stål	05002524	40:-
 C2, C3, C4	5405.55	12x1,25	26/52	Kona 60°	19	10.9 White Zincplated	Stål och aluminium	05002511	40:-
 Berlingo, C2, C3, C4, Saxo, Xsara	5405.66	12x1,25	26/47	Kona 60°	17	10.9 Geomet	Stål	05002526	40:-
 C1 07.05-06.14 (PM,PN)	5405.80	12x1,50	35/59,5	Bricka	17	10.9 Dacromet	Aluminium	05002618	40:-
 C1 07.14- (580W)	5405.85	12x1,50	33/53,5	Bricka	17	10.9 Dacromet	Aluminium	05002618	40:-







Bilmärke/bilmodell	Ersätter OEM art.nr.	Gänga	Gänglängd/ totallängd (mm)	Kona	Skalle	Kvalitet/ material	Passar fälgtyp	Art.nr.	Pris Exkl
CITROËN									
 Aircross (B) C-Crosser (V)	5405.82	12x1,50		Bricka	21	8 Chromeplated	Aluminium	05001697	40:-
 Jumper (lilla chassit) 03.94-03.02	5405.75	14x1,50	28/53	Kona 60°	24	10.9 Geomet	Stål	05002824	40:-
 C8 09.02-11.10	5405.69	14x1,50	26/56,5	Kona 60°	17	10.9 Geomet	Aluminium	05002819	40:-
 C8 09.02-11.10, Jumpy (lilla chassit) 04.02-05.06	5405.68	14x1,50	25/56,5	Kona 60°	17	10.9 Geomet	Stål	05002823	40:-
 Jumper (stora chassit) 06.06-08.14	5405.76	16x1,50	31/57	Kona 60°	24	10.9 Geomet	Stål	05003024	40:-
 Jumper (lilla chassit) 06.06-08.14	5405.78 5405.88	14x1,50	27/62	Kona 60°	21	10.9 Geomet	Stål och aluminium (endast 15" 5-118)	05002825	40:-
 Jumper (stora chassit) 06.06-08.14	5405.79	16x1,50	29/64	Kona 60°	21	10.9 Geomet	Stål och aluminium (endast 16" 5-130)	05003029	40:-
FIAT									
 Bravo 04.07-, Panda II, Punto II, 500 01.07-	13.230.425	12x1,25	22/48,5	Kona 60°	17	8.8 Dacromet	Stål och aluminium	05002516	40:-
 Grande Punto 10.05-, Croma 06.05-, Sedici 04.06-	51.732.885	12x1,50	22/47,5	Kona 60°	17	10.9 White Zincplated	Stål och aluminium	05002617	40:-

Bilmärke/bilmodell	Ersätter OEM art.nr.	Gänga	Gänglängd/ total längd (mm)	Kona	Skalle	Kvalitet/ material	Passar fälgtyp	Art.nr.	Pris Exkl
FIAT									
 DUCATO (lilla chassit) 03.94-03.02	1.345.713.080	14x1,50	28/53	Kona 60°	24	10.9 Geomet	Stål	05002824	40:-
 DUCATO (stora chassit) 04.02-05.06	1.345.714.080	16x1,50	31/57	Kona 60°	24	10.9 Geomet	Stål	05003024	40:-
 DUCATO (lilla chassit) 06.06-08.14	1.363.349.080 1.351.202.080	14x1,50	27/62	Kona 60°	21	10.9 Geomet	Stål och aluminium (endast 15" 5-118)	05002825	40:-
 DUCATO (stora chassit) 06.06-08.14	1.351.203.080	16x1,50	29/64	Kona 60°	21	10.9 Geomet	Stål och aluminium (endast 16" 5-130)	05003029	40:-
 Scudo 10.06-04.16	9.644.576.680	12x1,25	17/57	Bricka	17	10.9 Geomet	Aluminium	05002517	40:-
 Fullback (KTOT)	MR455707	12x1,50		Bricka	21	8 Chromeplated	Aluminium	05001697	40:-
FORD									
 KA 01.09-	1 559 373	12x1,25	22/48,5	Kona 60°	17	8.8 Dacromet	Stål och aluminium	05002516	40:-
 Ka 11.96-12.08, Fiesta 04.02-09.08	6.040.307	12x1,50		Kona 60°	19	8 Phosphated	Stål	05001663	40:-
 Fusion 10.02-06.12, Focus 12.04-02.11, Mondeo 06.07-09.14	1.007.487	12x1,50		Kona 60°	19	8 Phosphated	Stål	05001663	40:-







Bilmärke/bilmodell	Ersätter OEM art.nr.	Gänga	Gänglängd/ totallängd (mm)	Kona	Skalle	Kvalitet/ material	Passar fälgtyp	Art.nr.	Pris Exkl
FORD									
 Fiesta , Focus, C Max, Mondeo, Cougar, KA	6.111.766	12x1,50		Kona 60°	19	10 Stainless steel	Aluminium (öppen)	05001698	40:-
 Fiesta 10.08-, Focus 05.07- C-Max 10.10-, Kuga 06.08-	1.454.051	12x1,50		Kona 60°	19	10 Stainless steel	Aluminium (öppen)	05001698	40:-
 Fiesta, Focus, C Max, Mondeo, Cougar, KA	6.652.292	12x1,50		Kona 60°	19	10 Stainless steel	Aluminium (öppen)	05001698	40:-
 Fiesta 10.08-, Focus 05.07- C-Max 10.10-, Kuga 06.08-	1 454 053	12x1,50		Kona 60°	19	10 Stainless steel	Aluminium (öppen)	05001698	40:-
 Galaxy 09.95-04.01	7.201.016	14x1,50	34/66	Radius R14	19	10.9 Phosphated	Stål och aluminium	05002898	40:-
 Galaxy 05.01-06.06	1.126.877	14x1,50	34/62	Radius R14	19	10.9 Dacromet	Stål och aluminium	05002834	40:-
 S-Max 06.06- Galaxy 07.06-	1.377.748	14x1,50		Kona 60°	21	10 White Zincplated	Stål	05001878	80:-
 S-Max 06.06- Galaxy 07.06-	1.428.138 1.377.747	14x1,50		Kona 60°	21	10 Zincplated	Aluminium Stainless Steel	05001879	40:-
 Transit 2013 (single wheels only)	ACPA-1012-KXA	14x1,50		Kona 60°	21	10.9 White Zincplated 2Pcs	Aluminium	05001873-2	40:-









Bilmärke/bilmodell	Ersätter OEM art.nr.	Gänga	Gänglängd/ totallängd (mm)	Kona	Skalle	Kvalitet/ material	Passar fälgtyp	Art.nr.	Pris Exkl
FORD									
 Ford Transit 2000-2006 /2006-2011	1.576.434	14x2	25	Plan	21	10 Cromax + Magni	Stål	05001973	40:-
 Ford Transit 2013-	1.811.812	14x1,50	25	Plan	21	10 Zinclid + Magni	Stål	05001876	40:-
HYUNDAI									
 I10 (IA, PA), I20 (PB, GB) I30 (FD), I40 (VF), ix20 (JC) ix35 (EL), Kona (OS) Tucson (JM, TL)	52950-14140 52950-M1000 52951-31330	12x1,50		Kona 60°	21	8 Chromeplated	Aluminium	05001675	40:-
 I10 (IA, PA), I20 (PB, GB) I30 (FD), ix35 (EL) Kona (OS), Tucson (JM, TL)	52950-3Y000 52950-17000 52951-11210	12x1,05		Kona 60°	21	8 Chromeplated	Stål	05001676	40:-
JAGUAR									
 E-Pace (DF) F-Pace (DC)	T4A2670	14x1,50		Kona 60°	21	10 White Zincplated	Aluminium Stainless Steel	05001879	40:-
KIA									
 Carens (FC), Carnival Ceed (CD), Niro (DE) Picanto (TA), Rio (DE, UB) Sorento (XM, UM) Soul (AM, PS), Venga Sportage (QLE), Stonic (YB)	52950-14140 52950-M1000 52950-1G000 52950-H1000	12x1,50		Kona 60°	21	8 Chromeplated	Aluminium	05001675	40:-
 Carens (FC), Carnival Ceed (CD), Niro (DE) Picanto (TA), Rio (DE, UB) Sorento (XM, UM) Soul (AM, PS), Venga Sportage (QLE), Stonic (YB)	52950-3Y000 52950-17000 52951-11210	12x1,05		Kona 60°	21	8 Chromeplated	Stål	05001676	40:-

Bilmärke/bilmodell	Ersätter OEM art.nr.	Gänga	Gänglängd/ totallängd (mm)	Kona	Skalle	Kvalitet/ material	Passar fälgtyp	Art.nr.	Pris Exkl
LANCIA									
 Delta 08.08-, Kappa, Lybra, Musa 09.04-	13.230.425	12x1,25	22/48,5	Kona 60°	17	8.8 Dacromet	Stål	05002516	40:-
LAND ROVER									
 Defender -2006, Discovery I, Range Rover	ANR2763MMM	16x1,5		Bricka	27	8 Zincplated	Aluminium	05001490	80:-
 Discovery 2	ANR3679	14x1,5		Bricka	22	8 Zincplated	Aluminium	05001893	80:-
 Defender 2007-	RRD500560	14x1,5		Bricka	27	8 Zincplated	Aluminium	05001891	80:-
 Discovery III & IV, Range Rover Sport (LS) (LW) Range Rover Vouge (LM) (LG)	RRD500590	14x1,5		Bricka	22	8 Zincplated	Aluminium	05001892	80:-
 Range Rover Evoque (LV) Frelander (LF) Disc. sport (LC)	LR001381	14x1,5		Kona 60°	21	10 Zincplated	Aluminium Stainless steel	05001879	40:-
LEXUS									
 Lexus ES 07.01-, GS 08.97-, IS 01.99-, LS430, RX 02.03-	90942-01053	12x1,50		Bricka	21	8 Chromeplated	Aluminium	05001697	40:-
 Lexus ES300, GS 08.96-, GX470, IS 07.01-, LS 01.00-, RX 01.98-, SC 01.97-	90942-01858	12x1,50		Bricka	21	8 Chromeplated	Aluminium	05001696	40:-



Bilmärke/bilmodell	Ersätter OEM art.nr.	Gänga	Gänglängd/ total längd (mm)	Kona	Skalle	Kvalitet/ material	Passar fälgtyp	Art.nr.	Pris Exkl
LEXUS									
 Lexus LX470-570	90942-01103	14x1,50		Bricka	22	8 Chromeplated	Aluminium	05001897	40:-
MAZDA									
 3, 5, 6, 323, 626, MX3, MX5, MX6, Premacy	0603 26 161	12x1,50		Kona 60°	21	8 Yellow Zincplated	Stål	05001662	40:-
 CX-5, CX-7, CX-9 2 (DE, DJ, DL) 3 (BK, BL), 5 (CR, CW) 6 (GG, GH, GJ) MX-5 (NA, NB, NC, ND)	0B002-37-160 B002-37-160 KA78-37-160 UH72-37-160 UR58-37-160	12x1,50		Kona 60°	21	8 Chromeplated	Aluminium	05001675	40:-
 CX-5, CX-7, CX-9 2 (DE, DJ, DL) 3 (BK, BL), 5 (CR, CW) 6 (GG, GH, GJ) MX-5 (NA, NB, NC, ND)	0603-26-161A 0603-26-161 0603-26-161X	12x1,50		Kona 60°	21	8	Stål Chromeplated	05001676	40:-
MERCEDES									
 SLK R170, C-klass W203, CLK W208, CLK W209, E-klass W210	170 401 01 70 201 401 02 70 210 401 02 70	12x1,50	21/39,5	Radius R12	17	10.9 White Zincplated	Stål	05002602	40:-
 A-klass W169, W176, B-klass W245, W246, C-klass W204, W205, CLA C117, CLS W218 W219, E-klass W207 W211, W212, SL R230, GL W164, GLK W204, ML W163, W164, Vito W639	000 990 67 07 000 990 69 07 000 990 72 07 000 990 49 07 163 401 06 70 211 401 03 70	14x1,50	27/49	Radius R14	17	10.9 Geomet	Aluminium	05002827	40:-
 CL W215, E-klass W213 G-klass W461, W463 GLC W204X GLK W204 (steel wheels only) ML W164 (steel wheels only) R-klass W25 (steel wheels only) S-klass W140, W220	000 990 53 07	14x1,50	45/70	Radius R14	17	10.9 Deltaprotekt KL100	Aluminium och stål	05002845	40:-

Bilmärke/bilmodell	Ersätter OEM art.nr.	Gänga	Gänglängd/ totallängd (mm)	Kona	Skalle	Kvalitet/ material	Passar fälgtyp	Art.nr.	Pris Exkl
MERCEDES									
Bild saknas									
A-klass W176 B-klass W246 C-klass W204, W205 CLA C117, C118 E-klass W207, W212 GL W164, W166 GLA (W156)	000 990 83 07	14x1,50	27/46	Radius R14	17	9.8 Corrolube	Aluminium	05002845-1	40:-
Bild saknas									
CLS (C257) GL (W166) GLC (204X) ML (W166)	000 990 76 07	14x1,50	45/64	Radius R14	17	9.8 Corrolube	Aluminium	05002845-1	40:-
									
Sprinter I (207,209,209,210, 212,214,307,308,309 310,312,314) Sprinter II (906)	601 401 02 70	14x1,50	34/63	Radius R14	19	10.9 Zink, nickel + stål Finigard 105	Stål	05002834-2	40:-
									
Sprinter (616 (905); Vario 512 (667) 612 (668), 814 (670), 815 (670) 609 (668); 709 (669)	074361014205	14x1,50		Flat	19	10 White Zincplated	Stål	05007016	40:-
MINI									
									
Mini 10.01-10.06	06 36 13 0 141 574	12x1,50	26/51	Kona 60°	17	10.9 Black Zincplated	Stål och aluminium	05002622	40:-
									
Clubman F54 Convertible F57 (3rd gen) Cooper F55, Cooper S F55/F56 Countryman R60 Cupe R58 One R56 Paceman R61 Raodster R59	36 13 6 781 151-03	14x1,25	27/48	Kona 60°	17	8.8 Black Zincplated	Stål och aluminium	05002923	40:-
MITSUBISHI									
									
Carisma, Colt, Galant, Lancer, L300, Space Wagon	MR 297927 MA 103 087	12x1,50		Kona 60°	21	8 Yellow Zincplated	Stål	05001662	40:-

Bilmärke/bilmodell	Ersätter OEM art.nr.	Gänga	Gänglängd/ total längd (mm)	Kona	Skalle	Kvalitet/ material	Passar fälgtyp	Art.nr.	Pris Exkl
MITSUBISHI									
 ASX (GA0), Carisma (DA0), Colt (C50, CA0, CJ0, Z30, Z3B), Galant (E30, EA0), I-Miev (HA0, HAV), Lancer (CS0, CY0), L300 (PA0, PAOV, POOV, POOW), Outlander (CUOW, CWO), Pajero (H60W), Space Wagon (N10, N30, N50)	90942-01053	12x1,50		Bricka	21	8 Chromeplated	Aluminium	05001697	40:-
NISSAN									
 Micra K12 04.03-05.10, Note E11 03.06-09.13	40254-00QAB 40222-BC40A	12x1,50	25/51	Kona 60°	19	10.9 White	Stål och aluminium	05002619	40:-
 Qashqai J10 02.07-11.13, X-Trail T30 09.01-06.07, X-Trail T31 07.07-04.14	40224-G9501 40224-21001	12x1,25		Kona 60°	21	8 Yellow Zincplated	Stål	05001560-3	40:-
OPEL									
 Corsa A-B-C, Agila, Astra, Vectra, Omega, Signum, Meriva, Zafira A-B	1.008.504	12x1,50	22/47,5	Kona 60°	17	10.9 White Zincplated	Stål och aluminium	05002617	40:-
 Crossland X	5405.66	12x1,25	26/47	Kona 60°	17	10.9 Geomet	Stål	05002526	40:-
 Crossland X Grandland X	5405.67	12x1,25	17/57	Bricka	17	10.9 Geomet	Aluminium	05002517	40:-
PEUGEOT									
 106, 205, 206, 306, 307, 309, 405, 406	5405.35	12x1,25	17/63	Bricka	19	10.9 Chromed	Aluminium	05002518	40:-

Bilmärke/bilmodell	Ersätter OEM art.nr.	Gänga	Gänglängd/ totallängd (mm)	Kona	Skalle	Kvalitet/ material	Passar fälgtyp	Art.nr.	Pris Exkl
PEUGEOT									
 308, 3008, 407, Partner Tepee 05.08-	5405.72	12x1,25	26/49	Kona 60°	17	10.9 Geomet	Stål	05002524	40:-
 106, 205, 206, 306, 307, 309, 405, 406	5405.55	12x1,25	26/52	Kona 60°	19	10.9 White Zincplated	Stål	05002511	40:-
 106, 206, 207, 406, 1007	5405.66	12x1,25	26/47	Kona 60°	17	10.9 Geomet	Stål	05002526	40:-
 1007, 206, 207, 307, 308, 3008, 406, 407, 508, 5008, Partner Tepee 05.08	5405.67	12x1,25	17/57	Bricka	17	10.9 Geomet	Aluminium	05002517	40:-
 107 09.05-06.14	90942-W2002	12x1,50	35/59,5	Bricka	17	10.9 Geomet	Aluminium	05002618	40:-
 108 07.14- (580W)	5405.85	12x1,50	33/53,5	Bricka	17	10.9 Dacromet	Aluminium	05002618	40:-
 807 09.02-11.10	5405.69	14x1,50	26/56,5	Kona 60°	17	10.9 Geomet	Aluminium	05002819	40:-
 4007 (V); 4008 (B)	5405.82	12x1,50		Bricka	21	8 Chromeplated	Aluminium	05001697	40:-
 Expert 01.96-09.06	5405.68	14x1,50	25/56,5	Kona 60°	17	10.9 Geomet	Stål	05002823	40:-

Bilmärke/bilmodell	Ersätter OEM art.nr.	Gänga	Gänglängd/ totallängd (mm)	Kona	Skalle	Kvalitet/ material	Passar fälgtyp	Art.nr.	Pris Exkl
PEUGEOT									
 Boxer (lilla chassit) 03.94-03.02	5405.75	14x1,50	28/53	Kona 60°	24	10.9 Geomet	Stål	05002824	40:-
 Boxer (stora chassit) 03.94-03.02	5405.76	16x1,50	31/57	Kona 60°	24	10.9 Geomet	Stål	05003024	40:-
 Boxer (stora chassit) 04.02-05.06 Boxer (lilla chassit) 06.06-08.14	5405.78 5405.88	14x1,50	27/62	Kona 60°	21	10.9 Geomet	Stål och aluminium (endast 15" 5-118)	5002825	40:-
 Boxer (stora chassit) 06.06-08.14	5405.79	16x1,50	29/64	Kona 60°	21	10.9 Geomet	Stål och aluminium (endast 16" 5-130)	05003029	40:-
PORSCHE									
 911 (964), 924, 944	N 020 112 1	14x1,50		Radius R14	19	10 White Zincplated	Aluminium	05007021	40:-
 Boxter, Cayman, Panamera, 911 (930,964,993,996,997)	997 361 203 010	14x1,50	30/60	Radius R14	19	10.9 Deltaprotect KL100	Aluminium	05002839	80:-
 Macan	99635208602 WHT 006 978	14x1,50	30/60	Radius R14	19	10.9 Zinc nickel black	Aluminium	05002839-1	80:-
 Cayenne	7L0 601 139 A	14x1,50	37/67	Radius R14	19	10.9 White Zincplated	Aluminium	05002837	80:-
 Boxster, Cayman, 911		14x1,50		Radius stängd	19 Hex	Aluminium	Aluminium	05001875	80:-

Bilmärke/bilmodell	Ersätter OEM art.nr.	Gänga	Gänglängd/ total längd (mm)	Kona	Skalle	Kvalitet/ material	Passar fälgtyp	Art.nr.	Pris Exkl
SEAT									
 Toledo, Leon, Altea, Ibiza 07.08-, Cordoba 01.03- Exeo 03.09-	WHT 002 437	14x1,50	27/47,5	Radius R13	17	10.9 White Zincplated	Stål och aluminium	05002828	40:-
 Alhambra 05.96-04.01	701 601 139B	14x1,50	34/55	Radius R14	19	10.9 Phosphated	Stål och aluminium	05002898	40:-
 Alhambra 05.01-08.10	7M3 601 139B	14x1,50	34/62	Radius R14	19	10.9 Dacromet	Stål och aluminium	05002834	40:-
SKODA									
 Fabia, Octavia 04.97-05.04, Octavia 06.04-05.13, Roomster, Superb	WHT 002 437	14x1,50	27/47,5	Radius R13	17	10.9 White Zincplated	Stål och aluminium	05002828	40:-
SUZUKI									
 Ignis 09.03- SX-4 06.06-11.13, Swift III 05.05-	43423-86G00	12x1,50	22/47,5	Kona 60°	17	10.9 White Zincplated	Stål och aluminium	05002617	40:-
TESLA									
 Model S, Model X	ACPA-1012-KXA	14x1,50		Kona 60°	21	10.9 White Zincplated 2 Pcs	Aluminium	05001873-2	80:-
TOYOTA									
 Auris, Avensis, Carina, Corolla, Camry, Yaris, 4 Runner	90942-01007	12x1,50		Kona 60°	21	8 Yellow Zincplated	Stål	05001662	40:-
 Alla Toyota personbilar	90942-01033	12x1,50		Bricka	21	8 Chromeplated	Aluminium	05001697	40:-

Bilmärke/bilmodell	Ersätter OEM art.nr.	Gänga	Gänglängd/ total längd (mm)	Kona	Skalle	Kvalitet/ material	Passar fälgtyp	Art.nr.	Pris Exkl
TOYOTA									
 4 Runner, Land Cruiser, Prado, Rav4, Highlander	90942-01858	12x1,50		Bricka	21	8 Chromeplated	Aluminium	05001696	40:-
 Toyota Tundra, Land Cruiser 100-200-400	90942-01103	14x1,50		Bricka	22	8 Chromeplated	Aluminium	05001897	80:-
 Aygo 07.05-06.14	90942-W2002	12x1,50	35/59,5	Bricka	17	10.9 Geomet	Aluminium	05002618	40:-
 Aygo 07.14- (580W)	5405.85	12x1,50	33/53,5	Bricka	17	10.9 Dacromet	Aluminium	05002618	40:-
 Proace (V)	5405.67	12x1,25	17/57	Bricka	17	10.9 Geomet	Aluminium	05002517	40:-
 Proace (V)	160 873 44 80	12x1,25	26/49	Kona 60°	17	10.9 Geomet	Stål	05002524	40:-
VOLKSWAGEN									
 Transporter T2; Transporter T3	N 020 112 1	14x1,50 R14		Radius Zincplated	19	10 White	Aluminium	05007021	40:-
 Caddy 09.96-12.03, Golf I, II, III, Jetta I, II, Lupo 10.98-03.05, Vento 01.92-09.98	321601139 C 3A0 601 139	12x1,50	23,5/45,5	Radius R13	17	8.8 Yellow Zincplated	Stål och aluminium	05002623	40:-
 Sharan 05.95-04.01, Transporter T4 01.96-04.03	701 601 139 B 7M0 601 139A	14x1,50	34/55	Radius R14	19	10.9 Phosphated	Stål och aluminium	05002898	40:-

Bilmärke/bilmodell	Ersätter OEM art.nr.	Gänga	Gänglängd/ totallängd (mm)	Kona	Skalle	Kvalitet/ material	Passar fälgtyp	Art.nr.	Pris Exkl
VOLKSWAGEN									
 Sharan 05.01-04.10, Transporter T4 04.00-04.03	7M3 601 139 B	14x1,50	34/62	Radius R14	19	10.9 Dacromet	Stål och aluminium	05002834	40:-
 Bora, Beetle 10.98-09.11, Fox 04.05-, Golf IV, V, VI, VII, Passat 10.96-09.10, Phaeton, Tiguan 10.07- Touran 03.03-	8D0 601 139 D	14x1,50	27/47,5	Radius R13	17	10.9 White Zincplated	Stål och aluminium	05002828	40:-
 Touareg 10.02-04.10, Transporter T5	443 601 139 A 7L0 601 139 A	14x1,50	37/67	Radius R14	19	10.9 White Zincplated	Aluminium	05002837	80:-
 Touareg (CR)	8R0 601 295	14x1,50	30/59,5	Radius R14	17	10.9 Deltaprotekt KL100	Stål och aluminium	05002846	80:-
 Crafter 30/35 (2EC1,2FJ) LT28/35 (2Dm)		14x1,50	34/63	Radius R14	19	10.9 Zink Nickel + Finigard 105	Stål	05002834-2	40:-
VOLVO									
 S40 03.96-12.03, V40 03.96-12.03	30870000 30873148	12x1,50		Kona 60°	21	8 Yellow Zincplated	Stål	05001662	40:-
 S40 01.04-04.12, V50 04.04-04.12	8665333 999359	12x1,50		Kona 60°	19	8 Phosphated	Stål	05001663	40:-
 S60, S80, V70, XC70, XC90	31202337 30683076	14x1,50	34/60	Kona 60°	19	10.9 White Zincplated	Stål och aluminium	05002835	40:-
 C30, S40/V50, V40	3132645	12x1,50		Kona 60°	19	10 Stainless steel	Aluminium (öppen)	05001698	40:-



Bild	Art. nr	Benämning	Antal/förp	Pris ex. moms
1	050099150	TPMS Italsensor 3.0evo snap-in 433mhz	30	600:-
2	050099151	TPMS Italsensor 3.0evo clamp-in Slv 433mhz	30	600:-
3	050099152	TPMS Italsensor 3.0evo clamp-in Blk 433mhz	30	600:-
4	050099114-2	TPMS Sensor CUB Clamp-In 433Mhz Combo Silv (small)	20	600:-
5	050099115	TPMS Sensor CUB Clamp-In 433Mhz Combo Black	20	600:-
6	050099115-1	TPMS Sensor CUB Clamp-In 433Mhz Combo Black (small)	20	600:-
7	050099116	TPMS Sensor CUB Snap-in 433Mhz Combo Black		600:-
8	050099116-1	TPMS Sensor CUB Snap-in 433Mhz (small)	20	600:-
9	050099117	TPMS Sensor CUB Clamp-in 315Mhz Combo Silver	20	600:-



Bild	Art. nr	Benämning	Antal/förp	Pris ex. moms
1	050099161	Spare snap-in valve for Italsensor 3.0evo (10st)	10	400:-
1	050099161-1	Spare snap-in valve for Italsensor 3.0evo (1st)	1	44:-
2	050099162	Spare clamp-in Slv valve Italsensor 3.0evo (10st)	10	500:-
2	050099162-1	Spare clamp-in Slv valve Italsensor 3.0evo (1st)	1	55:-
3	050099163	Spare clamp-in Blk valve Italsensor 3.0evo (10st)	10	500:-
3	050099163-1	Spare clamp-in Blk valve Italsensor 3.0evo (1st)	1	55:-
4	050099164	Spare clamp-in Grey valve Italsensor 3.0evo (10st)	10	500:-
4	050099164-1	Spare clamp-in Grey valve Italsensor 3.0evo (1st)	1	55:-
5	050099165	Ersättningsventil snap-in Schrader highspeed	1	36:-
6	050099166	Ersättningsventil snap-in TPMS Schrader gen 4	1	46:-
7	050099167	Ersättningsventil snap-in TPMS Conti TG1D	1	64:-
8	050099168	Ersättningsventil snap-in TPMS Pacific	1	68:-



Bild	Art. nr	Benämning	Antal/förp	Pris ex. moms
1	0500990013	IT46 italsensor tool with OBD	1	7996:-
2	0500990014	IT41 italsensor tool with OBD	1	6996:-
3	050099001	CUB Programming tool Gen 4 incl. OBD	1	8796:-
4	0500990012	CUB TPMS Programeringsvertyg	1	6996:-



Bild	Art. nr	Benämning	Antal/förp	Pris ex. moms
1	05009181	Ventil PV TR413 monterad	100	260:-
2	05009181-1	Ventil PV TR413 lös hatt	100	260:-
3	05009181-2	Ventil PV TR413 lös hatt och nål	100	260:-
4	05009182	Ventil PV TR414 monterad	100	280:-
5	05009182-1	Ventil PV TR414 lös hatt	100	280:-
6	05009182-2	Ventil PV TR414 lös hatt och nål	100	280:-
7	05009183	Förstärkt ventil TR600XHP 6,9bar	1	23:-
8	05009184	Förstärkt skruvventil metal 14 bar	1	45:-
9	05009008	Ventil Chrome TR413	1	20:-
10	05009011	Ventil Skruv Dold / 4pack	4	320:-



Bild	Art. nr	Benämning	Antal/förp	Pris ex. moms
1	05009180-1	Ventilnål mässing	100	139:-
2	05009180-2	Ventilnål nickelbelagd (även för TPMS)	100	139:-
3	05009180-3	Ventilhatt svart	100	58:-



Bild	Art. nr	Benämning	Antal/förp	Pris ex. moms
1	05009200	Valve Truck TBL 1390 (Alive)	1	96:-
2	05009201	Valve Truck Trailer for super singel	1	96:-
3	05009202	Valve Truck 764 L.90mm	1	96:-
4	05009203	Valve Truck 65MSF L.40mm	1	96:-
5	05009204	Valve Truck TR-571-C L.57mm	1	96:-
6	05009205	Valve Truck TR-573-C L.82mm	1	96:-
7	05009206	Valve Truck Trailer (Small Valvehole) for super singel	1	96:-
8	05009207	Valve Truck Trailer (Reversed) for super singel	1	96:-



Bild	Art. nr	Benämning	Antal/förp	Pris ex. moms
1	05009101	5g zink vikter PV med clips stål fälg	100	184:-
2	05009102	10g zink vikter PV med clips stål fälg	100	272:-
3	05009103	15g zink vikter PV med clips stål fälg	100	340:-
4	05009104	20g zink vikter PV med clips stål fälg	100	416:-
5	05009105	25g zink vikter PV med clips stål fälg	100	496:-
6	05009106	30g zink vikter PV med clips stål fälg	100	576:-
7	05009107	35g zink vikter PV med clips stål fälg	50	320:-
8	05009108	40g zink vikter PV med clips stål fälg	50	376:-
9	05009109	45g zink vikter PV med clips stål fälg	50	408:-
10	05009110	50g zink vikter PV med clips stål fälg	50	456:-



Bild	Art. nr	Benämning	Antal/förp	Pris ex. moms
1	05009121	5g zink vikter PV med clips aluminium fälg	100	172:-
2	05009122	10g zink vikter PV med clips aluminium fälg	100	256:-
3	05009123	15g zink vikter PV med clips aluminium fälg	100	320:-
4	05009124	20g zink vikter PV med clips aluminium fälg	100	396:-
5	05009125	25g zink vikter PV med clips aluminium fälg	100	460:-
6	05009126	30g zink vikter PV med clips aluminium fälg	100	536:-
7	05009127	35g zink vikter PV med clips aluminium fälg	50	320:-
8	05009128	40g zink vikter PV med clips aluminium fälg	50	368:-
9	05009129	45g zink vikter PV med clips aluminium fälg	50	416:-
10	05009130	50g zink vikter PV med clips aluminium fälg	50	440:-



Bild	Art. nr	Benämning	Antal/förp	Pris ex. moms
1	05009143	Klistervikt PV steel grey 60g (4x5g+4x10g)	100	468:-
2	05009144	Klistervikt PV steel black 60g (4x5g+4x10g)	100	490:-

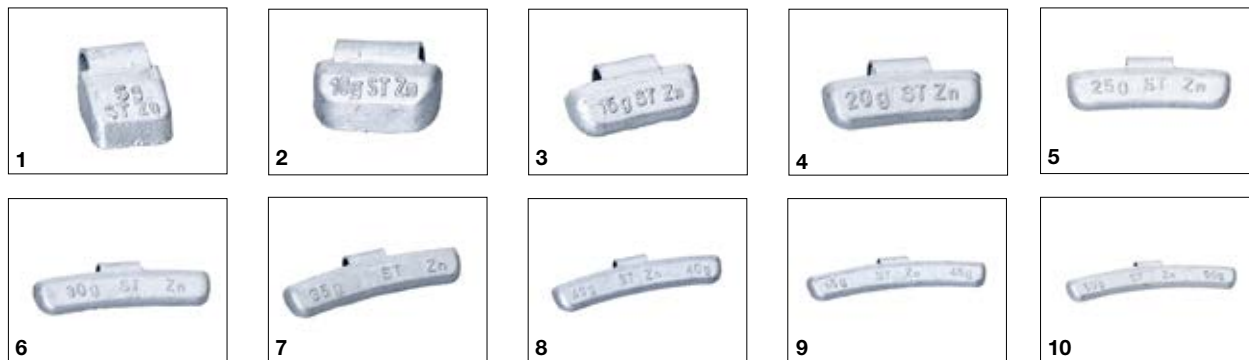

Bild	Art. nr	Benämning	Antal/förp	Pris ex. moms
1	05009154	Klistervikt PV steel rulle 5kg		700:-
2	05009155	Klistervikt PV steel grey rulle 5kg		790:-
3	05009156	Klistervikt PV steel black rulle 5kg		790:-

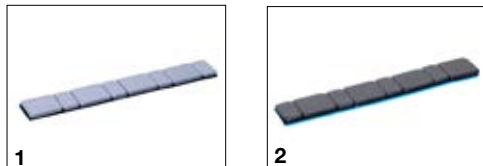

Bild	Art. nr	Benämning	Antal/förp	Pris ex. moms
1	05009131	50g bly vikt LV med clips	50	596:-
2	05009132	75g bly vikt LV med clips	50	680:-
3	05009133	100g bly vikt LV med clips	50	836:-
4	05009134	150g bly vikt LV med clips	25	588:-
5	05009135	200g bly vikt LV med clips	25	752:-
6	05009136	250g bly vikt LV med clips	25	908:-
7	05009137	300g bly vikt LV med clips	20	860:-



Bild	Art. nr	Benämning	Antal/förp	Pris ex. moms
1	05009161	Klistervikt bly LV 100g (4x25g)	25	552:-
2	05009162	Klistervikt bly LV 200g (4x50g)	25	992:-

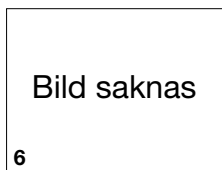

Bild	Art. nr	Benämning	Antal/förp	Pris ex. moms
1	05009166	Klistervikt MC bly 50g (7x5g 6x2,5g)	100	1072:-
2	05009167	Klistervikt MC bly black 50g (7x5g 6x2,5g)	100	1712:-



1



2



3



4



5



6

Bild	Art. nr	Benämning	Antal/förp	Pris ex. moms
1	05009191	Monteringspasta PV white 5kg	1	252:-
2	05009192	Monteringspasta PV transparent 5kg	1	272:-
3	05009195	Pastaborste rak	1	68:-
4	05009196	Pastaborste vinklad	1	236:-
5	05009199	Däckkrita Vit 17,5mm	12	388:-
6	050099231	Hållare för däckkrita	1	56:-



1



2



3



4



5



6

Bild	Art. nr	Benämning	Antal/förp	Pris ex. moms
1	050099201	Gummitrissa för borttagning av klistrerester 6 mm fäste	1	160:-
2	050099202	Tandad gummitrissa för borttagning av klistrerester	1	184:-
3	050099211	Ventildragare med gummiskydd	1	108:-
4	050099212	Ventilnålsmejsel	1	32:-
5	050099204	Mejsel för borttagning av klistervikter	1	98:-
6	050099205	Tång för borttagning av vikter	1	272:-



1



2

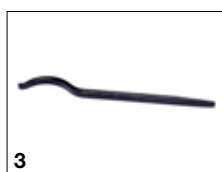

3



4

Bild	Art. nr	Benämning	Antal/förp	Pris ex. moms
1	050099221	Däckjärn PV 500mm	1	176:-
2	050099222	Däckjärn LV 800mm	1	1180:-
3	050099223	Däckjärn LV 520mm	1	976:-
4	050099224	Klinchlåstång	1	2576:-



Bild	Art. nr	Benämning	Antal/förp	Pris ex. moms
1	050099281	Hylssats slim för aluminiumfälg 17mm	1	192:-
2	050099281-1	Hylssats slim för aluminiumfälg 19mm	1	192:-
3	050099281-2	Hylssats slim för aluminiumfälg 21mm	1	192:-



Bild	Art. nr	Benämning	Antal/förp	Pris ex. moms
1	050099291	Lyftblock gummi för fordonslyft 160x120x40 (mm)	1	176:-
2	050099292	Lyftblock gummi för fordonslyft 160x120x60 (mm)	1	192:-
3	050099293	Lyftblock gummi för fordonslyft 160x120x70 (mm)	1	218:-
4	050099294	Lyftblock gummi för fordonslyft 160x120x80 (mm)	1	236:-

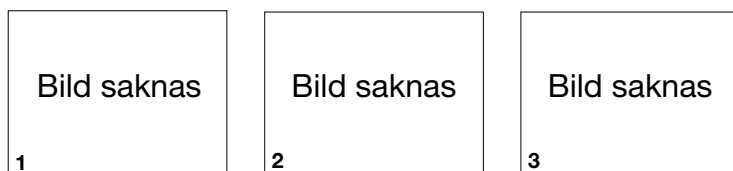

Bild	Art. nr	Benämning	Antal/förp	Pris ex. moms
1	050099241	Hållare klisterviktsrulle med viktskala och klippare	1	3780:-
2	050099242	Golvställ till hållare klisterviktsrulle	1	2180:-
3	050099243	Extra knivblad 2st	1	398:-
4	050099244	Extra viktskala	1	1298:-



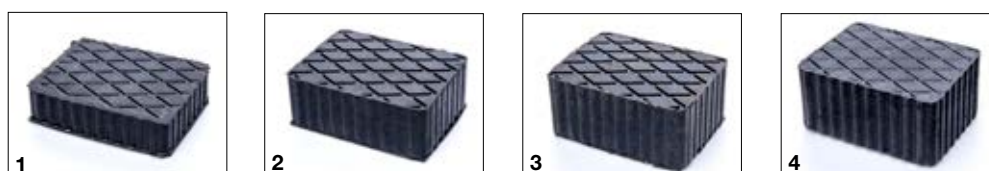

Mätverktyg

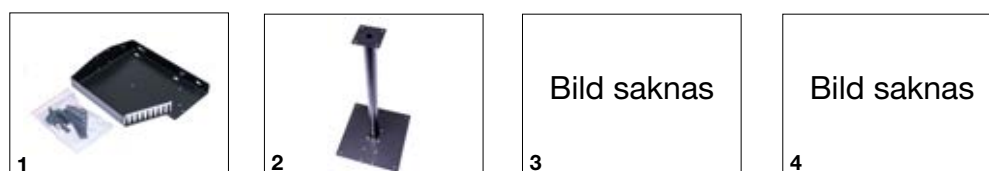



Bild	Art. nr	Benämning	Antal/förp	Pris ex. moms
1	358	Gängprovartavla HC (Plast)	1	800:-
2	353	Bultcirkelmätare	1	200:-
3	355	Gängtolk (Fickmodell)	1	400:-
4	354	Centrumhålmätare 54-90 mm	1	500:-
5	188	Mutter/Bult Påse SpF	1	40:-



SPEEDLINE TRUCKS ventiler är speciellt tillverkade för smidda lättmetallfälgar. Nedanstående rekommenderade momentvärden gäller endast för original SPEEDLINE TRUCK-ventiler. För alla liknande ETRTO ventiltypen nämnda som alternativ nedan, vänligen använd de momentvärden respektive producent rekommenderar.

Typ	Fälgstorlekar som passar	SPEEDLINE TRUCK-fälgar som passar	Lev. Art.Nr	Artikelnummer	Tekniska detaljer	Anmärkningar
SLT-003	 17.5x6.75" 22.5x8.25" 22.5x9.00"	SLT 2901, SLT 2911, SLT 2900, SLT 2897, SLT 2907	SLT-003	05009213	TRA typ: TR 553 DIN 54MS	Rekommenderat moment: 3-5 Nm
SLT-004	 17.5x6.75"	SLT 2891, SLT 3086	SLT-004	05009214	TRA typ: TR 544C ETRTO typ: V3.22.1	Rekommenderat moment: 3-5 Nm
SLT-020	 19.5x7.50", 22.5x11.75", ETO 22.5x13.00"	SLT 3087, SLT 2889, SLT 3099, SLT 3187	SLT-020	05009209	TRA typ: TR 543C ETRTO typ: V3.22.1	Rekommenderat moment: 3-5 Nm
SLT-021	 19.5x14.00" ET 120 22.5x11.75" ET 0, ET 45 ET 120, ET 135	SLT 2899, SLT 2888, SLT 2898, SLT 3063, SLT 3598, SLT 3774	SLT-021	05009210	TRA typ: TR 542 ETRTO typ: V3.20.1	Rekommenderat moment: 3-5 Nm
SLT-022	 22.5x7.50" 22.5x9.00"	SLT 3201, SLT 3211, SLT 2887	SLT-022	05009215	DIN 70MS-07	Rekommenderat moment: 3-5 Nm

Ventilförlängningar

Förlängningsbas 	45° för dubbelmontage	För alla dimensioner i dubbelmontage, vid extern hjulposition	SLT-007	05009216	Material: mässing	-
Ventilförlängningar 	115 mm längd 150 mm längd	SLT 2901, SLT 2911, SLT 3086, SLT 3087 SLT 2900, SLT 3201, SLT 3211, SLT 2887, SLT 2897, SLT 2907	SLT-008 SLT-009	05009211 05009212	Material: technopolymer	-



Mutter/bult-sortiment

Spara fraktkostnader och hjälp kunden (och dig själv) direkt, genom att ha de mest vanliga muttrar och bultar i lager.

Innehåller 18 st. olika artikelnummer, med totalt 720 st mutter och bult. Både eftermarknad och OE.

Innehåller följande:

05001570 - Mutter 12x1,25 Kona Stängd (19Hex) H34

05001670 - Mutter 12x1,50 Kona Stängd (19Hex) H34

05002530 - Bult 12x1,25 Kona L28 (17Hex)

05002620 - Bult 12x1,50 Kona L26 (17Hex)

05002830 - Bult 14x1,50 Kona L28 (17Hex)

05002927 - Bult 14x1,25 Kona L27 (17Hex)

05002601 - Bult 12x1,50 Radius L21 (17Hex)

05002821 - Bult 14x1,50 Radius L27 (17Hex)

05001671 - Mutter 12x1,50 Radius Stängd H27 (19Hex) (O.E Honda)

05001697 - Mutter 12x1,50 Bricka Stängd (21Hex) (O.E Toyota)

05001698 - Mutter 12x1,50 Lös Kona Stängd (19Hex) (O.E Ford)

05001879 - Mutter 14x1,50 Lös Kona Stängd (21Hex) (O.E Ford)

05002517 - Bult 12x1,25 Bricka L17 (17Hex) (O.E Citroen/Peugeot)

05002518 - Bult 12x1,25 Bricka L17 (19hex) (O.E Peugeot)

05002834 - Bult 14x1,50 Radius L34 (19 Hex) (R14) (O.E Seat, Vw)

05002835 - Bult 14x1,50 Kona L34 (19Hex) (O.E Volvo)

05002922 - Bult 14x1,25 Kona L27 (17Hex) Blk (O.E BMW)

05003024 - Bult 16x1,50 Kona L31 (24Hex) (O.E Fiat)



Låssatser

Komplett låssortiment med de vanligaste låssatserna.

Totalt 45 st satser.

Artikelnummer	Beskrivning
0500459030	Låsbult 12x1,25 KONA 30 mm
0500469023	Låsbult 12x1,50 KONA 23 mm
0500469026	Låsbult 12x1,50 KONA 26 mm
0500469033	Låsbult 12x1,50 KONA 33 mm
0500479033	Låsbult 12x1,75 KONA 33 mm
0500489026	Låsbult 14x1,50 KONA 26 mm
0500489033	Låsbult 14x1,50 KONA 33 mm
0500499027	Låsbult 14x1,25 KONA/TUNER 27 mm
0500469123	Låsbult 12x1,50 RADIUS 23 mm
0500469127	Låsbult 12x1,50 RADIUS 27 mm
0500489129	Låsbult 14x1,50 RADIUS 29 mm
0500457000	Låsmutter 12x1,25 KONA Stängd
0500466000	Låsmutter 12x1,50 KONA Öppen
0500467000	Låsmutter 12x1,50 KONA Stängd
0500487000	Låsmutter 14x1,50 KONA Stängd



Ringsortiment

Spara fraktkostnader och hjälp kunden (och dig själv) direkt, genom att ha de vanligaste centreringsringarna från Specialfålgar i lager.

Innehåller 30 st. olika artikelnummer och finns två olika utföranden, 120 st. ringar eller 240 st. ringar

Artikelnummer	Beskrivning
601571	Centrumringar 60,1-57,1
633541	Centrumringar 63,3-54,1
633561	Centrumringar 63,3-56,1
633566	Centrumringar 63,3-56,6
633571	Centrumringar 63,3-57,1
633601	Centrumringar 63,3-60,1
651634	Centrumringar 65,1-63,4
666571	Centrumringar 66,6-57,1
671571	Centrumringar 67,1-57,1
671651	Centrumringar 67,1-65,1
731541	Centrumringar 73,1-54,1
731561	Centrumringar 73,1-56,1
731566	Centrumringar 73,1-56,6
731571	Centrumringar 73,1-57,1
731581	Centrumringar 73,1-58,1
731601	Centrumringar 73,1-60,1
731634	Centrumringar 73,1-63,4

PRISER & ALLMÄNT

- Denna prislista annullerar föregående. Specialfälgar i Kungsbacka AB (härefter benämnt i villkoren som Specialfälgar) förbehåller sig rätten att omgående ändra priserna vid t ex kraftiga valuta- eller råvaruförändringar med avisering senast 30 dagar innan.
- Beställningar faktureras alltid till de priser som gäller leveransdagen oberoende av beställningsdatum.
- Vid order understigande 500 kr tillkommer en expeditionsavgift om 25 kr exkl. moms.
- Specialfälgar försöker i största möjliga mån att ha dagsuppdaterad information vad gäller bilmodeller, passningslistor, bil-fälgkopplingar och aktuella registreringsnummerkopplingar. Det åligger dock alltid kunden att kontrollera senast inkommen information innan fälgarna monteras på bilen. Specialfälgar står aldrig för eventuella skador som uppkommit på bilen eller fälgen när fälgar eller tillbehör monteras.

BETALNINGSVILLKOR

- Efter sedvanlig kreditprövning bestäms betalningsvillkoren. Specialfälgar förbehåller sig rätten att neka kunder köp.
- Specialfälgar förbehåller sig rätten att när som helst, utan föregående avisering, att lägga kunder mot Efterkrav, Förskottsbetalning eller spärra kundkontot för vidare köp.
- Efter förfallodagen debiteras en dröjsmålsränta med f.n. 18 %.

RETURER/REKLAMATIONER

- Alla eventuella reklamationer och/eller returer skall föregås av samtal med Specialfälgar.
- Felleverans måste meddelas Specialfälgar inom 10 arbetsdagar, därefter kommer eventuella returer inte att accepteras.
- På returer/reklamationer utan retursedel debiteras en hanteringskostnad om 250 kr exkl. moms.
- För returnerade varor som ej är rengjorda eller skadats av exempelvis felaktig emballering görs avdrag om upp till 100 % på kreditnotan.
- På varor som ej returnerats i originalkartong görs ett avdrag om 10 % på kreditnotan.
- Ej godkända returer skickas tillbaka till avsändaren med mottagarfrakt och en hanteringskostnad debiteras om 250 kr exkl. moms.

TRANSPORTSKADOR

- Kontrollera alltid att mottaget gods är oskadat och komplett i samråd med transportören direkt vid mottagandet. Skriv aldrig på gods du inte fysiskt sett.
- Ansvaret för att anmäla eventuella transportskador åligger alltid mottagande part.
- Anmälan av dold transportskada skall göras till transportören inom 7 arbetsdagar.
- Vid nekad ersättning från transportör står aldrig Specialfälgar skyldig att ersätta mottagande part.

MONTERING

- Innan du monterar däcken, provmontera fälgarna på bilen. Finns det inte möjlighet till detta så kontrollera att bult-cirkel och inpressning stämmer med din beställning och, vid fullgången restorder, senaste uppgifterna om fälg-bilpassingen tillgängliga hos Specialfälgar.
- Kontrollera att fälgarna monteras kloss an bilens anläggningsyta. I vissa fall krävs det att man demonterar små skruvar, brickor eller dylikt.
- Demontera ALDRIG detaljer som påverkar bilens funktionalitet och/eller säkerhet.
- Se till att både bilens och fälgens anläggningsytor är jämna och rena.
- Om monteringskit medföljer fälgen skall detta användas. Kontrollera eventuella centrumringars mått, bultarnas längd och muttrarnas djup så att dessa ej tar i några bromsdetaljer eller botten i skallen etc.
- Använd lämpligt vattenbaserat smörjmedel på däckfoten för att underlätta monteringen och var noga med att inte skrapa monteringsverktyget mot fälgkanten eller ekrarna vid montering.
- Muttermaskin bör ej användas vid montering av lättmetallfälgar.
- Efterdra muttrarna/bultarna efter c:a 10 mils körning.

Specialfälgar ansvarar aldrig för eventuella skador som kan uppstå genom användandet av våra produkter, ej heller för monterings- och servicekostnader vid om-/av-/påläggning av däck eller eventuellt merjobb med ompackning och transport. Specialfälgar kommer aldrig att stå för uppkomna merkostnader för produkter vi inte levererar, exempelvis däck eller liknande.

HELBILSGODKÄNNANDE

- För att ta reda på om bilen är godkänd för en viss typ av fälg, hänvisas till respektive bilmärkesrepresentant. Specialfälgar tar inget ansvar för icke godkända dimensioner och spårvidder till enskilda bilmodeller. Rådfråga din lokala gummiverkstad.
 - I katalog/fälgguide uppger vi originalinpressning på samtliga europeiska bilar samt inpressningsdjupet på våra fälgar.
 - Observera att avvikelser kan förekomma för vissa bilar där vi uppger att originalkåpa, originalmutter/bult samt centrumhål passar.
 - Vid användandet av fälgar från Specialfälgar kan i vissa fall modifiering av skärmkanter eller hårdare fjädrar och stötdämpare erfordras.
 - När vi säljer en originalanpassad fälg till en nyare bil, där original mutter/bult passar, skickar vi inte med mutter/bult!
- Specialfälgar ansvarar ej för problem uppkomna vid användandet av fälgar listade i denna katalog gentemot "Helbils godkännandet".**

GARANTI

- Vi lämnar tre (3) års garanti på samtliga produkter fr.o.m. försäljningsdatum. Undantaget alla kromfälgar där vi lämnar ett (1) års garanti.
- Undantag från garantin: Skador på fälgar som orsakas av stenskott, felaktig rengöring, vägsalt, bromsdamm eller yttre påverkan. Skador på fälgar som orsakas av felaktig hantering vid montering, demontering eller balansering.
- Teknisk support och eventuella garantianspråk rörande TPMS-sensorer (med tillbehör) hänvisas för Italmatic till Specialfälgar (tel. 0300-729 00) respektive CUB till SECUB AB (tel. 08-64 64 211).

SPECIALFÄLGAR I KUNGSBACKA AB

Borgåsvägen 2, 434 39 Kungsbacka
Tel. 0300-729 00 E-mail: info@specialfalgar.se



Fälgdim.	Art.nr.	Lev.-art.nr	Pris/st ex. moms	Bultcirkel	Navhål (mm)	Inpr. (mm)	Bulthål	Bult/nav centr.	Typ	Max.bel. (kg)	Antal/pall	Anm.
6,00x17,5	600 600 175 10	14020V*	1408:-	6-205	161	116	Kona	(MZ)	Std	1550	20	
6,00x17,5	600 600 175 11	35038V*	1408:-	6-245	202	114,5	Rak M18	MZ	ALV	1850	20	
6,00x17,5	600 600 175 09	14008V*	1408:-	6-245	202	121,5	Rak M18	MZ	ALV	1850	20	
6,00x17,5	600 600 175 06	14014V*	1408:-	6-245	191	121,5	Rak M20	MZ	ALV	1850	20	
6,00x17,5	600 600 175 05	14015V*	1408:-	10-225	176	122,5	Kona	(MZ)	Std	3150	20	
6,75x17,5	600 675 175 03	14019V*	1460:-	6-205	161	0	Kona	(MZ)	ALV	2725	20	
6,75x17,5	600 675 175 10	35037V*	1460:-	6-245	202	128	Rak M18	MZ	ALV	2240	20	
6,75x17,5	600 675 175 12	14009V*	1460:-	6-245	202	145	Rak M18	MZ	ALV	2360	20	
6,75x17,5	600 675 175 11	14007V*	1460:-	8-275	221	135	Rak M20	MZ	ALV	2360	20	
6,75x17,5	600 675 175 05	14017V*	1460:-	10-225	176	128	Kona	(MZ)	Std	3150	20	
6,75x19,5	600 675 195 04	35367V*	2056:-	8-275	221	133	Kona	(MZ)	ALV	2500	16	U DCW-G3
6,75x19,5	600 675 195 05	35366V*	2056:-	8-275	221	133	Rak M20	MZ	ALV	2500	16	U DCW-G3
6,75x19,5	600 675 195 03	11085**	2056:-	10-225	221	127	Kona	(MZ)	Std	2500	16	
7,50x19,5	600 750 195 07	35368V*	1709:-	8-275	221	138	Rak M22	MZ	ALV	2800	16	U DCW-G3
7,50x19,5	600 750 195 04	35370V*	1709:-	8-275	221	144	Kona	(MZ)	ALV	3000	16	U DCW-G3
7,50x19,5	600 750 195 05	35369V*	1709:-	8-275	221	144	Rak M20	MZ	ALV	3000	16	U DCW-G3
7,50x19,5	600 750 195 08	11054**	1709:-	10-225	176	0	Kona	(MZ)	ALV	2725	16	
7,50x19,5	600 750 195 10	35552V*	1709:-	10-225	176	140	Kona	(MZ)	Std	2725	16	U DCW-G3
8,25x19,5	600 825 195 04	35554V*	1908	8-275	221	0	Kona	BZ	ALV	3800	16	U DCW-G3
8,25x19,5	600 825 195 08	35371V*	1908	8-275	221	157	Rak M20	MZ	ALV	3150	16	U DCW-G3
8,25x19,5	600 825 195 09	35555V*	1908:-	8-275	221	65	Rak	MZ	Std	3150	16	U DCW-G3
8,25x19,5	600 825 195 01	819BC**	1908:-	10-225	176	REV	Kona	(MZ)	ALV	3150	16	
8,25x19,5	600 825 195 06	35553V*	1908:-	10-225	176	66	Rak M22	MZ	ALV	3750	16	U DCW-G3
8,25x19,5	600 825 195 03	35503V*	1908:-	10-225	176	148	-	(MZ)	Std	3150	16	U DCW-G3
11,75x19,5	60 1175 195 01	35423V*	2560:-	8-275	221	0	Rak M22	MZ	ALV	4500	12	
11,75x19,5	60 1175 195 02	35421V*	2560:-	10-335	281	0	Rak M22	MZ	ALV	4500	12	
11,75x19,5	60 1175 195 03	35422V*	2560:-	10-335	281	120	Rak M22	MZ	ALV	4500	12	
14,00x19,5	60 1400 195 04	35426V*	2560:-	8-275	221	0	Rak M22	MZ	ALV	4500	8	
14,00x19,5	60 1400 195 05	35424V*	2560:-	10-335	281	0	Rak M22	MZ	ALV	4500	8	
14,00x19,5	60 1400 195 06	35425V*	2560:-	10-335	281	120	Rak M22	MZ	ALV	4500	8	
6,75x22,5	600 675 225 03	15130V*	2588:-	8-275	221	132	Rak M20	MZ	Std	2800	12	
6,75x22,5	600 675 225 02	11039**	2588:-	10-335	281	129	Rak M22	MZ	Std	2800	12	
7,50x22,5	600 750 225 01	15014**	1980:-	8-275	221	141,5	Rak M20	MZ	ALV	3150	12	
7,50x22,5	600 750 225 10	15096V*	1980:-	8-275	221	141,5	Rak M20	MZ	ALV	3150	12	
7,50x22,5	600 750 225 02	15124V*	1980:-	8-275	221	147	Rak M20	MZ	ALV	3250	12	U DCW-G3
7,50x22,5	600 750 225 12	15121V*	1980:-	10-335	281	148	Rak M22	MZ	ALV	3750	12	U DCW-G3
7,50x22,5	600 750 225 15	15107V*	1980:-	10-335	281	152,5	Rak M22	MZ	ALV	3250	12	U DCW-G3
7,50x22,5	600 750 225 14	15123V*	1980:-	10-335	281	88	Rak M22	MZ	ALV	3550	12	U DCW-G3
8,25x22,5	600 825 225 12	15098V*	1980:-	10-335	281	152	Rak M22	MZ	ALV	3750	12	U DCW-G3
8,25x22,5	600 825 225 05	15024**	1980:-	10-335	281	152	Rak M22	MZ	ALV	3550	12	
8,25x22,5	600 825 225 06	15025**	1980:-	10-335	281	152	Kona	BZ	ALV	3550	12	
8,25x22,5	600 825 225 02	15119V*	1980:-	10-335	281	157	Rak M22	MZ	ALV	3750	12	U DCW-G3
9,00x22,5	600 900 225 10	15099V*	1756:-	10-335	281	162,5	Rak M22	MZ	ALV	4000	12	U DCW-G3
9,00x22,5	600 900 225 09	35470V*	1916:-	10-335	281	120	Rak M22	MZ	Std	4000	12	U DCW-G3

För pallpriser, rådfråga oss!



Fälgdim.	Art.nr.	Lev.-art.nr	Pris/st ex. moms	Bultcirkel	Navhål (mm)	Inpr. (mm)	Bulthål	Bult/nav centr.	Typ	Max.bel. (kg)	Antal/pall	Anm.
11,75x22,5	60 1175 225 07	35054V	2012	10-335	281	0	Kona	(MZ)	ALV	5000	12	
11,75x22,5	60 1175 225 15	15084V*	1872	10-335	281	0	Rak M22	MZ	ALV	5000	12	
11,75x22,5	60 1175 225 21	35511V*	2012	10-335	281	REV	Rak M22	MZ	ALV	5000	12	
11,75x22,5	60 1175 225 24	15122V*	2012	10-335	281	45	Rak M22	MZ	ALV	5000	12	
11,75x22,5	60 1175 225 06	15083V*	1872	10-335	281	120	Rak M22	MZ	ALV	5000	12	
11,75x22,5	60 1175 225 11	15073V*	1992	10-335	281	135	Rak M22	MZ	ALV	5000	12	
11,75x22,5	60 1175 225 13	15125V*	2064	10-335	281	140	Rak M22	MZ	ALV	3550	12	
11,75x22,5	60 1175 225 18	15126V*	2064	10-335	281	160	Rak	MZ	Std	4750	12	
13,00x22,5	60 1300 225 01	35526V*	3292	10-335	281	120	Rak M22	MZ	ALV	5150	8	
13,00x22,5	60 1300 225 02	35527V*	3292	10-335	281	0	Rak M22	MZ	ALV	5150	8	
15,00x22,5	60 1500 225 02	14003V*	3556	10-335	281	120	Rak M22	MZ	ALV	5300	8	
15,00x22,5	60 1500 225 03	35055**	3556	10-335	281	25	Rak M22	MZ	ALV	5300	8	
15,00x22,5	60 1500 225 06	11108V*	3556	10-335	281	0	Rak M22	MZ	ALV	5300	8	
15,00x22,5	60 1500 225 05	11169**	3556	10-335	281	-35	Rak M22	MZ	ALV	5300	8	

Fälgar som är markerade med grått är storsäljare!

* = Ventil sitter monterad i fälgen.

** = Utgår vid Slut.

MZ = Mittcentererad fälg med raka bulthål. Använd endast mutter med rak/plan bricka.

BZ = Bultcentererad fälg med koniska bulthål på utsidan och i vissa fall även på insidan.

(MZ) = Dessa fälgar kan användas för både mittcenterering och/eller bultcenterering.

Denna typ av fälg kan monteras med både koniska och raka muttrar.

ALV = Alive fälg med ventilen placerad utanför fälgdisken. Anpassad för bilar med skivbroms men passar även till fordon med trumbromsar.

Std = Enbart till fordon med trumbromsar. Ventilen sitter placerad innanför fälgdisken.

DCW-G3 - Vår nyaste generation av lastbilsfälgar



Fälg med hump

Fälg med DCW-G3

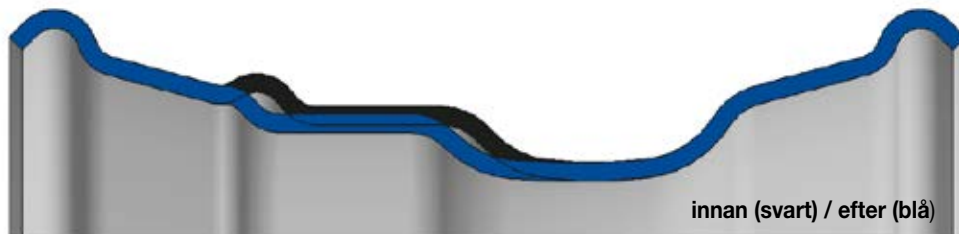









innan (svart) / efter (blå)

Direkt jämförelse

- Ökad nyttolast på grund av ökad viktoptimering (ny form på fälgen)
- Ingen hump - enklare av-/påmontering av däck
- Kompatibel med standard extern ventil (ALV)
- Kompatibilitet med godkända TMP-system
- Finns i alla vanliga fälgdimensioner
- Europeisk OE-kvalitet
- Patenterad utveckling











































































Fälgdim.	Fälgkod	Beteckning	Art. nummer	Ytfinish	Pris/st exkl. moms	Antal bulthål Bultcirck. PCD	Bulthål Ø mm	Inpr. ET (mm)	ABE-nummer (Tyskland)	Max. bel. (kg)	Fälgvikt (kg)	Navhål Ø mm	Disk- tjocklek (mm)	Half dual space (mm)	Dubbel- mont.	Ventiltyp	
6.75x17.5 6 hole 	SLT 2901	2901AM	700675 175201	Diamond	4 856:-	6-245	26	125	KBA 49488	2 500	14,9	202	21,0	146	Yes	SLT-003	
		2901 APH	700675 175101	Högglass- polerad inv/utv	5 676:-		26										
6.75x17.5 8 hole 	SLT 2911	2911AM	700675 175211	Diamond	4 856:-	8-275	24	125	KBA 49855	2 500	14,4	221	21,0	146	Yes	SLT-003	
		2911 APH	700675 175111	Högglass- polerad inv/utv	5 676:-		24										
		2911 BM	700675 175221	Diamond	4 856:-		30										
		2911 BPH	700675 175121	Högglass- polerad inv/utv	5 676:-		30										
6.75x17.5 10 hole 	SLT 3086	3086 AM	700675 175231	Diamond	4 856:-	10-225	26	117	KBA 48650	3 000	14,6	176	22,0	139	Yes	SLT-004	
7.50x19.5 8 hole 	SLT 3097	3097 AM	700750 195297	Diamond	4 732:-	8-275	26	134	KBA 48984	3 150	18,0	221	21,0	155	Yes	SLT-020	
		3097 BM	700750 195297	Diamond	4 732:-		32										
8.25x19.5 8 hole 	SLT 4015	4015 CM	700825 19501	Diamond	4 856:-	8-275	26	145	KBA 51417	3 150	18,8	221	21,0	167	Yes	SLT-003	
		4015 AM	700825 19502	Diamond	4 856:-		30										
		4015 BM	700825 19503	Diamond	4 856:-		32										
14.00x19.5 10 hole 	SLT 3598	3598 AM	701400 195201	Diamond	6 232:-	10-335	26	120	KBA 50537	4 500	22,9	281	28,0	~	No	SLT-021	
		3598 BM	701400 195202	Diamond	6 232:-		32										
7.50x22.5 	SLT 3211	3211 AM	700750 225201	Diamond	5 396:-	10-335	26	138	KBA 49688	3 750	24,0	281	23,5	162	Yes	SLT-022	
		3211 BM	700750 225211	Diamond	5 396:-		32										
8.25x22.5 	SLT 2900	2900 AM	700825 225201	Diamond	5 396:-	10-335	26	146	KBA 48829	3 750	23,3	281	20,5	166,5	Yes	SLT-003	
		2900 APH	700825 225101	Högglass- polerad inv/utv	6 376:-		26										
		2900 BM	700825 225211	Diamond	5 396:-		32										
		2900 BPH	700825 225111	Högglass- polerad inv/utv	6 376:-		32										
9.00x22.5 	SLT 2887	2887 AM	700900 225201	Diamond	5 396:-	10-335	26	151	KBA 48286	4 250	25,6	281	23,5	174	Yes	SLT-022	
		2887 APH	700900 225101	Högglass- polerad inv/utv	6 376:-		26										
		2887 BM	700900 225211	Diamond	5 396:-		32										
		2887 BPH	700900 225111	Högglass- polerad inv/utv	6 376:-		32										





































































speedline

Fälgdim.	Fälgkod	Beteckning	Art. nummer	Ytfinish	Pris/st exkl. moms	Antal bult hål Bultcirk. PCD	Bulthål Ø mm	Inpr. ET (mm)	ABE-nummer (Tyskland)	Max. bel. (kg)	Fälgvikt (kg)	Navhål Ø mm	Disk-tjocklek (mm)	Half dual space (mm)	Dubbelmont.	Ventiltyp	
 11.75x22.5 ET 0	SLT 3099	3099 AM	701175 225221	Diamond	5 392:-	10-335	26	0	KBA 49335	5 000	22,3	281	24,0	~	No	SLT-020	
		3099 APT	701175 225121	Höggglans-polerad utv.	6 088:-		26										
		3099 BM	701175 225231	Diamond	5 392:-		32										
		3099 BPT	701175 225131	Höggglans-polerad utv.	6 088:-		32										
 11.75x22.5 ET 45	SLT 3774	3774 AM	701175 50353	Diamond	6 088:-	10-335	26	45	KBA 50353	5 000	24	281	24,0	~	No	SLT-021	
		3774 BM	701175 225271	Diamond	6 088:-		32										
 11.75x22.5 ET 120	SLT 2888/SLT 3018	3018 AM	701175 225202	Diamond	5 672:-	10-335	26	120	KBA 48285	5 000	25,5	281	26,0	~	No	SLT-021	
		2888 APT	701175 225101		6 368:-		26										
		2888 BM	701175 225211	Diamond	5 672:-		32										
		2888 BPT	701175 225111	Höggglans-polerad utv.	6 368:-		32										
 13.00x22.5	SLT 3187	3187 AM	701300 225201	Diamond	6 648:-	10-335	26	-14	KBA 49687	5 800	27,9	281	28,0	~	No	SLT-020	
		3187 BM	701300 225202	Diamond	6 648:-		32										
 9.00x22.5 Design	SLT 2907	2907 AM	700900 225401	Diamond	5 536:-	10-335	26	153	KBA 49856	4 250	23,7	281	22,0	175	Yes	SLT-003	
		2907 APH	700900 225301	Höggglans-polerad inv/utv.	6 500:-		26										
		2907 BM	700900 225411	Diamond	5 536:-		32										
		2907 BPH	700900 225311	Höggglans-polerad inv/utv.	6 500:-		32										
 11.75x22.5 ET 120 Design	SLT 2898	2898 AM	701175 225401	Diamond	5 672:-	10-335	26	120	KBA 48898	5 000	24,2	281	25,0	~	No	SLT-021	
		2898 APT	701175 225301	Höggglans-polerad utv.	6 368:-		26										
		2898 BM	701175 225411	Diamond	5 672:-		32										
		2898 BPT	701175 225311	Höggglans-polerad utv.	6 368:-		32										
 11.75x22.5 ET 135 Design	SLT 3063	3063 AM	701175 225441	Diamond	5 672:-	10-335	26	135	KBA 48899	5 000	26,0	281	25,0	~	No	SLT-021	
		3063 APT	701175 225341	Höggglans-polerad utv.	6 368:-		26										
		3063 BM	701175 225451	Diamond	5 672:-		32										
		3063 BPT	701175 225351	Höggglans-polerad utv.	6 368:-		32										

Nr Modell	Dim.	Pris brutto exkl. moms	Nr Modell	Dim.	Pris brutto exkl. moms	
1 Nitro Aero FF G.Blk 	8,5x18	2 368:-	8 Nitro Volcano G.Gun 	8,5x19	2 632:-	
	7,5x19	2 808:-		9,5x19	2 632:-	
	8x19	2 808:-		8,5x20	2 896:-	
	8,5x19	2 808:-		9x20	2 896:-	
	7,5x20	3 068:-		9,5x20	2 896:-	
	8x20	3 068:-		10,5x20	2 896:-	
	8,5x20	3 068:-		9x21	3 324:-	
2 Nitro Aero FF G.Gun/Pol 	9x20	3 068:-	9,5x21	3 324:-		
	8,5x18	2 456:-	10,5x21	3 324:-		
	8x19	2 888:-	9 Nitro Volcano 	8,5x19	2 696:-	
	8,5x19	2 888:-		9,5x19	2 696:-	
	8x20	3 168:-		8,5x20	2 968:-	
8,5x20	3 168:-	9x20		2 968:-		
3 Nitro Aero FF D.Slv 	9x20	3 168:-	9,5x20	2 968:-		
	8,5x18	2 368:-	10,5x20	2 968:-		
	7,5x19	2 808:-	9x21	3 396:-		
	8x19	2 808:-	9,5x21	3 396:-		
	8,5x19	3 068:-	10,5x21	3 396:-		
	7,5x20	3 068:-	10 Nitro Spark G.Blk/Grey 	8x18	2 088:-	
	8x20	3 068:-		8,5x20	2 796:-	
8,5x20	3 068:-	11 Nitro Spark G.Blk/Red 		8x18	2 088:-	
9x20	3 068:-			8,5x20	2 796:-	
4 Nitro Throne FF 	8,5x20	3 036:-		12 Nitro Sabre G.Blk 	7,5x17	1 832:-
	9x20	3 036:-			8x17	1 864:-
	10x20	3 184:-			8x18	2 096:-
	10,5x20	3 184:-	8,5x19		2 572:-	
	8,5x21	3 356:-	8,5x20		2 880:-	
	9,5x21	3 356:-	13 Nitro Magnum Max bel. 900 kg 		9x20	2 456:-
	10x21	3 416:-			9x22	2 836:-
	10,5x21	3 416:-			10,5x22	2 836:-
	11x21	3 416:-	14 Advanti Inizio DST 		8x18	2 296:-
	9x22	3 768:-			8,5x18	2 296:-
	9,5x22	3 768:-			9x18	2 296:-
10,5x22	3 944:-	8x19		2 644:-		
11x22	3 944:-	8,5x19		2 644:-		
5 Nitro Sapphire FF 	7,5x18	2 368:-	9,5x19	2 644:-		
	8x18	2 424:-	15 ATS Antares 	6x15	828:-	
	8,5x18	2 424:-		6,5x16	1 000:-	
	7,5x19	2 744:-		7x16	1 000:-	
	8x19	2 808:-		7x17	1 252:-	
	8,5x19	2 808:-		7,5x17	1 252:-	
	8x20	3 068:-		8x18	1 660:-	
8,5x20	3 128:-	16 ATS Antares G.Blk 		6x15	856:-	
9x20	3 128:-		6,5x16	1 040:-		
6 Nitro Turismo FF 	8x19		2 696:-	7x16	1 040:-	
	8,5x19		2 696:-	7x17	1 292:-	
	9x19		2 796:-	7,5x17	1 292:-	
	9,5x19	2 796:-	8x18	1 708:-		
	10x19	2 888:-	17 ATS Evolution 	7x16	996:-	
	10,5x19	2 888:-		7,5x17	1 252:-	
	8x20	2 888:-		8x17	1 252:-	
	8,5x20	2 888:-		7x18	1 660:-	
	9x20	2 976:-		7,5x18	1 660:-	
	7 Nitro Turismo FF G.Gun/Pol 	9x20	2 976:-	8x18	1 660:-	
		10x20	3 068:-	8x19	2 136:-	
10,5x20		3 068:-	9x19	2 456:-		
11x20		3 176:-	18 ATS Evolution G.Grey 	7x16	1 036:-	
11,5x20		3 176:-		7,5x17	1 292:-	
9 Nitro Volcano 		8x19		2 784:-	8x17	1 292:-
		8,5x19		2 784:-	7x18	1 708:-
		9x19		2 888:-	7,5x18	1 708:-
		10x19	2 976:-	8x18	1 708:-	
		10,5x19	2 976:-	8x19	2 200:-	
		8x20	2 976:-	9x19	2 520:-	
	8,5x20	2 976:-				
9x20	3 028:-					
10x20	3 172:-					
10,5x20	3 172:-					
11x20	3 248:-					
11,5x20	3 248:-					

Nr Modell	Dim.	Pris brutto exkl. moms	Nr Modell	Dim.	Pris brutto exkl. moms
19 ATS Mizar	6,5x16 7,5x16 6,5x17 7x17 7,5x17 8x18 8,5x18 8x19 8,5x19	996:- 1 016:- 1 252:- 1 252:- 1 252:- 1 660:- 1 660:- 2 052:- 2 296:-	29 CSP 16 M.Gun	5x14 5,5x15 6x15 6,5x16 7x16 7x17 7,5x17 7,5x18	832:- 852:- 852:- 1 000:- 1 000:- 1 252:- 1 252:- 1 664:-
20 ATS Mizar G.Blk	6,5x16 7,5x16 6,5x17 7x17 7,5x17 8x18 8,5x18 8x19 8,5x19	1 036:- 1 056:- 1 292:- 1 292:- 1 292:- 1 708:- 1 708:- 2 200:- 2 332:-	30 Image Colt	6,5x16 7,5x17 8x18 8,5x19 8,5x20	1 328:- 1 576:- 1 896:- 2 376:- 2 696:-
21 CSP 18 G.Blk/Pol	6,5x16 7,5x17 8x17 8x18 8x19 9x19	1 328:- 1 548:- 1 548:- 2 084:- 2 548:- 2 548:-	Image Colt SUV G.Blk/Pol	8,5x19 Max bel. 1026 kg 9x20	2 788:- 3 296:-
22 CSP 18	6,5x16 7,5x17 8x17 8x18 8x19 9x19	1 164:- 1 464:- 1 464:- 2 000:- 2 464:- 2 464:-	31 Image Colt L.Gun	6,5x16 7,5x17 8x18 8,5x19 8,5x20	1 248:- 1 500:- 1 840:- 2 320:- 2 640:-
23 CSP 18 G.Blk	6,5x16 7,5x17 8x17 8x18 8x19 9x19	1 164:- 1 464:- 1 464:- 2 000:- 2 464:- 2 464:-	Image Colt SUV L.Gun	8,5x19 Max bel. 1026 kg 9x20	2 696:- 3 196:-
24 CSP 13	6x15 6,5x16 7x17 7,5x18 8x18 8x19	1 000:- 1 164:- 1 464:- 2 000:- 2 000:- 2 464:-	32 Image Star FF G.Blk/Pol	6,5x17 7x17 7,5x17 7,5x18 8x18 8,5x18 9x18	1 576:- 1 576:- 1 576:- 1 956:- 1 956:- 1 956:- 1 956:-
25 CSP 13 M.Gun	6x15 6,5x16 7x17 7,5x18 8x18 8x19	1 000:- 1 164:- 1 464:- 2 000:- 2 000:- 2 464:-	33 Image Star FF L.Gun	6,5x17 7x17 7,5x17 7,5x18 8x18 8,5x18 9x18	1 476:- 1 476:- 1 476:- 1 856:- 1 856:- 1 856:- 1 856:-
26 CSP 15	6,5x16 7x17	1 296:- 1 596:-	34 Image Star FF Slv	7,5x18 8x18 8,5x18 9x18	1 856:- 1 856:- 1 856:- 1 856:-
27 CSP 15 M.Blk	6,5x16 7x17	1 296:- 1 596:-	35 Image Comet G.Blk/Pol	6x15 6x16	996:- 1 096:-
28 CSP 16	5x14 5,5x15 6x15 6,5x16 7x16 7x17 7,5x17 7,5x18	832:- 852:- 852:- 1 000:- 1 000:- 1 252:- 1 252:- 1 664:-	36 Image Comet	5x14 5,5x14 5x15 6x15 6x16	832:- 832:- 900:- 900:- 1 000:-
			37 Image Comet Slv	5,5x14 5x15 6x15 6x16	832:- 900:- 900:- 1 000:-
			38 Image Thor	8x18 8,5x19	1 908:- 2 412:-
			39 Image Ride HL M.Gun	5x13 Max bel. 4-100 750 kg 5,5x14 Max bel. 5-112 1000 kg 6x15	1 080:- 1 168:- 1 380:-
			40 Image Ride	5x13 5,5x14 6x15 Image Ride HL 5x13 Max bel. 4-100 750 kg 5,5x14 Max bel. 5-112 1000 kg 6x15	880:- 940:- 1 060:- 1 080:- 1 168:- 1 380:-

Nr Modell	Dim.	Pris brutto exkl. moms	Nr Modell	Dim.	Pris brutto exkl. moms
41 Image Ride Blk/Pol	5x13	980:-	54 Image Vector Slv	6,5x16	1 476:-
  	5,5x14	1 040:-	Max bel. 900 kg	7x17	1 896:-
  	6x15	1 148:-	   		
Image Ride HL Blk/Pol	5x13	1 180:-	55 Image Strong G.Blk/Pol	6x15*	1 816:-
Max bel. 4-100 750 kg	5,5x14	1 268:-	*=Max bel. 1200 kg	6,5x16**	2 200:-
Max bel. 5-112 1000 kg	6x15	1 424:-	**=Max bel. 1400 kg	6,5x17**	2 476:-
				7,5x18**	2 996:-
42 Image Stella	6,5x16	1 088:-	56 Image Strong	6x15*	1 664:-
   	7x16	1 088:-	*=Max bel. 1200 kg	6,5x16**	1 964:-
	7x17	1 272:-	**=Max bel. 1400 kg	6,5x17**	2 268:-
	7,5x17	1 272:-	 	7,5x18**	2 768:-
	7,5x18	1 636:-	57 Image Strong M.Gun	6x15*	1 664:-
	8x18	1 636:-	*=Max bel. 1200 kg	6,5x16**	1 964:-
43 Image Stella M.Blk	6,5x16	1 088:-	**=Max bel. 1400 kg	6,5x17**	2 268:-
   	7x16	1 088:-	 	7,5x18**	2 768:-
	7x17	1 272:-	58 Image Solid Gun/Pol	6,5x16	2 200:-
	7,5x17	1 272:-	Max bel. 1400 kg		
	7,5x18	1 636:-			
	8x18	1 636:-	59 Image Solid	6,5x16	1 964:-
44 Image Legend	6,5x16	1 088:-	Max bel. 1400 kg		
   	7x16	1 088:-	 		
	7,5x17	1 272:-	60 Image Montana G.Blk	8,5x20	2 820:-
	8x18	1 636:-	Max bel. 955 kg		
45 Image Motion	6x15	908:-	6-130 Max bel. 1180 kg		
    	6,5x16	1 088:-	 		
	7x16	1 088:-	61 Image Montana Slv	8,5x20	2 820:-
	7x17	1 272:-	Max bel. 955kg		
	8x17	1 272:-	6-130 Max bel. 1180kg		
	8x18	1 636:-	 		
	8x19	1 908:-	62 Image Rock G.Blk/Pol	7,5x17	1 956:-
46 Image Motion G.Gun	6x15	908:-	Max bel. 955 kg	7,5x18	2 296:-
    	6,5x16	1 088:-	 		
	7x16	1 088:-	63 Image Rock	7,5x17	1 856:-
	7x17	1 272:-	Max bel. 955 kg	7,5x18	2 196:-
	8x17	1 272:-	  		
	8x18	1 636:-	64 BM Macho	7x16	1 632:-
	8x19	1 908:-	Max bel. 955 kg	7,5x17	1 856:-
47 Image Brio	6x15	908:-	   	8x18	2 196:-
	6,5x15	908:-		9x20	2 996:-
	6,5x16	1 088:-	65 BM Macho M.Blk	7x16	1 632:-
	7x17	1 272:-	Max bel. 955 kg	7,5x17	1 856:-
48 Image Spirit	6,5x16	996:-	   	8x18	2 196:-
	7x16	996:-		9x20	2 996:-
	7x17	1 164:-	66 Ballistic Dakota Blk/Pol	9x20	2 828:-
49 Image Rebel	4,5x14	948:-	Max bel. 955 kg	9x22	3 128:-
	5x15	1 132:-	67 Ballistic Dakota	9x20	2 664:-
50 Image Rebel M.Blk	4,5x14	948:-	Max bel. 955 kg	9x22	2 956:-
	5x15	1 132:-			
51 Nitro Hammer	8x18	1 776:-			
Max bel. 880 kg	8,5x20	2 476:-			
Nitro Hammer HL	8x18	1 912:-			
Max bel. 1000 kg	8,5x20	2 588:-			
   					
52 Image Vector Blk/Pol	6,5x16	1 756:-			
Max bel. 900kg	7x17	2 000:-			
  					
53 Image Vector	6,5x16	1 476:-			
Max bel. 900 kg	7x17	1 896:-			
   					

Nr Modell	Dim.	Pris brutto exkl. moms	Nr Modell	Dim.	Pris brutto exkl. moms
68 Ballistic Morax 	9x17	2 312:-	80 MSW 27T G.Bik/Pol    	8,5x18	1 788:-
	9x18	2 460:-			
	9x20	2 728:-			
69 Ballistic Guillotine	9x17	2 528:-	81 MSW 79 Blk/Pol     	6,5x16	1 156:-
	9x18	2 608:-		7x17	1 356:-
	9x20	2 872:-		7x18	1 456:-
	12x22	3 044:-		7,5x18	1 456:-
70 Ballistic Ravage	9x18	2 608:-	82 MSW 85 G.Bik    	6x15	1 100:-
	9x20	2 872:-		6,5x16	1 264:-
	9,5x22	3 036:-		7x17	1 416:-
71 CSP 10    	5x19	1 916:-	83 MSW 77 Matt Grey     	5x14	732:-
				6x15	840:-
72 CSP 10 M.Bik    	5x19	1 916:-	84 MSW 55 M.Dark Grey     	7x16	972:-
				6,5x16	952:-
73 CSP Work Max bel. 955 kg	6x15	1 500:-	85 MSW 48 Van Blk/Pol Max bel. 1350 kg 5-120 Max bel. 1100 kg     	7x16	1 668:-
				7x17	1 496:-
74 Advanti Peak Max bel. 955 kg	8x16	1 476:-	86 MSW 48 Van Max bel. 1350 kg 5-120 Max bel. 1100 kg     	8,5x18	1 496:-
				8,5x19	1 728:-
				8,5x20	1 496:-
				9,5x20	1 496:-
				9,5x21	1 496:-
				8,5x21	1 496:-
75 MSW 50 G.Bik     	8x18	1 896:-	88 Sparco Dakar    	5,5x16	1 596:-
	8x19	2 200:-			
	8,5x19	2 200:-			
	8,5x20	2 476:-			
	9,5x20	2 476:-			
	8,5x21	3 024:-			
	76 MSW 48 M.Bik     	6,5x16		1 396:-	
		7,5x17		1 696:-	
		8x18		2 016:-	
		8x19		2 368:-	
		9x19		2 440:-	
		6,5x20		2 048:-	
		8,5x20		2 796:-	
9,5x20		2 896:-			
9x21		3 456:-			
9,5x21		3 496:-			
10x21	3 544:-				
11,5x21	3 668:-				
77 MSW 40 Blk/Pol     	7x17	1 596:-			
	8x18	1 796:-			
	7,5x19	1 976:-			
	8x19	1 976:-			
	9x19	2 076:-			
	8,5x20	2 876:-			
	9x20	2 876:-			
	10x20	2 996:-			
	11x20	2 996:-			
78 MSW 30 G.Bik F.Pol    	7,5x17	1 496:-			
	7,5x18	1 796:-			
	8x18	1 796:-			
	8,5x18	1 796:-			
	9x18	1 796:-			
	7,5x19	1 976:-			
	8x19	1 976:-			
	8,5x19	1 976:-			
	9x19	1 976:-			
	9,5x19	2 076:-			
8,5x20	2 376:-				
9,5x20	2 396:-				
79 MSW 27T G.Gun    	8,5x18	1 696:-			

Modell	Dim.	Pris brutto exkl. moms	Modell	Dim.	Pris brutto exkl. moms
Breyton GTS-R Slv	7x17	4 000:-	Breyton GTS2 H.Slv	8,5x19	5 524:-
Undercut	7x18	4 324:-	Flow Forming	9,5x19	5 984:-
	7,5x18	4 608:-		8,5x20	7 080:-
	8,5x18	5 000:-		9,5x20	7 220:-
				10x20	7 348:-
Breyton GTS-R M.Gun	7x17	3 880:-	Breyton GTS2 M.Gun	8,5x19	5 256:-
Undercut	7x18	4 188:-	Flow Forming	9,5x19	5 768:-
	7,5x18	4 400:-		8,5x20	6 824:-
	8,5x18	4 800:-		9,5x20	6 956:-
				10x20	7 080:-
Breyton GTS-R M.Blk	7x17	3 880:-	Breyton GTS2 M.Blk	8,5x19	5 256:-
Undercut	7x18	4 188:-	Flow Forming	9,5x19	5 768:-
	7,5x18	4 400:-		8,5x20	6 824:-
	8,5x18	4 800:-		9,5x20	6 956:-
				10x20	7 080:-
Breyton GTS-R M.Blk/Red Circle	7x17	4 000:-	Breyton GTX H.Slv	8,5x20	6 968:-
	7x18	4 324:-	Flow Forming	10x20	7 220:-
	7,5x18	4 608:-			
	8,5x18	4 940:-	Breyton GTX M.Gun/Pol	8,5x20	6 712:-
Breyton GTS-R M.Gun/Red Circle	7x17	4 000:-	Flow Forming	10x20	6 968:-
	7x18	4 324:-			
	7,5x18	4 608:-	Breyton GTX M.Blk/Pol	8,5x20	6 712:-
	8,5x18	4 940:-	Flow Forming	10x20	6 968:-
Breyton Magic CW H.Dark	7,5x18	4 724:-			
	8,5x19	5 132:-	Breyton Fascinate H.Slv	8,5x19	6 560:-
Breyton Magic CW M.Grey	7,5x18	4 456:-	Flow Forming	9,5x19	6 900:-
	8,5x19	4 848:-		8,5x20	7 300:-
				10x20	7 744:-
Breyton Magic CW G.Blk	7,5x18	4 456:-		9x21	8 356:-
	8,5x19	4 848:-		10,5x21	8 900:-
				9x22	9 480:-
Breyton Magic CW	7,5x18	4 800:-	Breyton Fascinate M.Gun	10x22	10 016:-
M.Grey/Red Lip	8,5x19	5 256:-	Flow Forming	11,5x22	10 616:-
Breyton Magic	7,5x18	4 800:-		8,5x19	6 316:-
CW M.Grey/Orange Lip	8,5x19	5 256:-		9,5x19	6 544:-
				8,5x20	6 956:-
Breyton GTS H.Slv	7,5x18	4 072:-		10x20	7 348:-
	8,5x18	4 188:-		9x21	7 960:-
	8,5x19	4 940:-		10,5x21	8 508:-
	9,5x19	5 068:-		9x22	9 080:-
	8,5x20	5 460:-		10x22	9 620:-
	10x20	5 856:-		11,5x22	10 216:-
	9x21	7 364:-	Breyton Fascinate M.Blk	8,5x19	6 316:-
	10x21	7 628:-	Flow Forming	9,5x19	6 544:-
Breyton GTS M.Gun	7,5x18	3 880:-		8,5x20	6 956:-
	8,5x18	4 060:-		10x20	7 348:-
	8,5x19	4 670:-		9x21	7 960:-
	9,5x19	4 800:-		10,5x21	8 508:-
	8,5x20	5 196:-		9x22	9 080:-
	10x20	5 652:-		10x22	9 620:-
	9x21	6 968:-		11,5x22	10 216:-
	10x21	7 224:-	Breyton Topas H.Slv	8,5x19	6 636:-
Breyton GTS M.Blk	7,5x18	3 880:-	Flow Forming	9,5x19	6 776:-
	8,5x18	4 060:-		10x19	7 080:-
	8,5x19	4 670:-		8,5x20	7 364:-
	9,5x19	4 800:-		9x20	7 424:-
	8,5x20	5 196:-		9,5x20	7 488:-
	10x20	5 652:-		10x20	7 628:-
	9x21	6 968:-		10,5x20	7 820:-
	10x21	7 224:-		9x21	8 396:-
Breyton GTS G.Blk	8,5x19	4 670:-		9,5x21	8 496:-
	9,5x19	4 800:-		10,5x21	8 900:-
	8,5x20	5 196:-		9x22	9 748:-
	10x20	5 652:-		10x22	10 016:-
			Breyton Topas M.Gun	8,5x19	6 380:-
			Flow Forming	9,5x19	6 570:-
				10x19	6 776:-
				8,5x20	6 968:-
				9x20	7 032:-

Modell	Dim.	Pris brutto exkl. moms	Modell	Dim.	Pris brutto exkl. moms
	9,5x20	7 080:-		9,5x19	5 500:-
	10x20	7 236:-		8,5x20	5 652:-
	10,5x20	7 424:-		9,5x20	6 048:-
	9x21	8 012:-		10x20	6 176:-
	9,5x21	8 100:-		9x21	6 812:-
	10,5x21	8 508:-		10x21	7 080:-
	9x22	9 348:-		11,5x21	7 364:-
	10x22	9 620:-		9x22	7 400:-
Breyton Topas M.Blk Flow Forming	8,5x19	6 380:-		10x22	7 732:-
	9,5x19	6 570:-		11,5x22	8 076:-
	10x19	6 776:-	Breyton LS M.Blk	7,5x18	3 880:-
	8,5x20	6 968:-		8,5x18	4 060:-
	9x20	7 032:-		8,5x19	4 864:-
	9,5x20	7 080:-		9,5x19	5 500:-
	10x20	7 236:-		8,5x20	5 652:-
	10,5x20	7 424:-		9,5x20	6 048:-
	9x21	8 012:-		10x20	6 176:-
	9,5x21	8 100:-		9x21	6 812:-
	10,5x21	8 508:-		10x21	7 080:-
	9x22	9 348:-		11,5x21	7 364:-
	10x22	9 620:-		9x22	7 400:-
Breyton BR-I H.Slv	7,5x17	2 196:-		10x22	7 732:-
	7x18	2 348:-		11,5x22	8 076:-
	7,5x18	2 348:-	Breyton LS 2 H.Slv	8,5x19	5 424:-
	7,5x19	2 896:-		9,5x19	5 880:-
	8x19	2 896:-		8,5x20	6 060:-
	8,5x19	2 896:-		9,5x20	6 508:-
	9x19	2 896:-		10x20	6 712:-
	8x20	3 224:-		9x21	7 628:-
	8,5x20	3 224:-		10,5x21	8 012:-
	9x20	3 224:-		9x22	8 520:-
	9x20	3 544:-		10x22	8 612:-
	9,5x20	3 544:-		11,5x22	9 136:-
	9,5x21	4 220:-	Breyton LS 2 M.Gun	8,5x19	5 156:-
Breyton BR-I M.Blk	7,5x17	2 196:-		9,5x19	5 640:-
	7x18	2 348:-		8,5x20	5 816:-
	7,5x18	2 348:-		9,5x20	6 252:-
	7,5x19	2 896:-		10x20	6 444:-
	8x19	2 896:-		9x21	7 236:-
	8,5x19	2 896:-		10,5x21	7 616:-
	9x19	2 896:-		9x22	8 128:-
	8x20	3 224:-		10x22	8 216:-
	8,5x20	3 224:-		11,5x22	8 740:-
	9x20	3 224:-	Breyton LS 2 M.Blk	8,5x19	5 156:-
	9x20	3 544:-		9,5x19	5 640:-
	9,5x20	3 544:-		8,5x20	5 816:-
	9,5x21	4 220:-		9,5x20	6 252:-
Breyton Hibonit H.Slv Flow Forming	8,5x20	7 364:-		10x20	6 444:-
	10x20	7 744:-		9x21	7 236:-
Breyton Hibonit M.Blk Flow Forming	8,5x20	6 968:-		10,5x21	7 616:-
	10x20	7 348:-		9x22	8 128:-
Breyton Hibonit M.Gun/Pol Flow Forming	8,5x20	7 616:-		10x22	8 216:-
Breyton LS H.Slv	10x20	8 000:-	Breyton LS 2 M.Blk/Pol Face	11,5x22	8 740:-
	7,5x18	4 060:-		8,5x19	5 676:-
	8,5x18	4 188:-		9,5x19	6 164:-
	8,5x19	5 132:-		8,5x20	6 340:-
	9,5x19	5 616:-		9,5x20	6 776:-
	8,5x20	5 908:-		10x20	6 968:-
	9,5x20	6 112:-		9x21	7 884:-
	10x20	6 380:-		10,5x21	8 268:-
	9x21	7 208:-		9x22	8 916:-
	10x21	7 476:-		10x22	9 000:-
	11,5x21	7 756:-		11,5x22	9 528:-
	9x22	7 796:-	Breyton GTP H.Slv	8,5x19	5 524:-
	10x22	8 128:-		9,5x19	5 616:-
	11,5x22	8 472:-		8,5x20	6 112:-
Breyton LS M.Gun	7,5x18	3 880:-		10x20	6 570:-
	8,5x18	4 060:-		9x21	7 960:-
	8,5x19	4 864:-		10,5x21	8 036:-

Modell	Dim.	Pris brutto exkl. moms	Modell	Dim.	Pris brutto exkl. moms		
Breyton GTP M.Gun	8,5x19	5 256:-	Breyton Spirit RS Blk Forged Anodized	9x21	18 900:-		
	9,5x19	5 460:-		10x21	20 200:-		
	8,5x20	5 768:-		9x19	14 900:-		
	10x20	6 252:-		10x19	16 300:-		
	9x21	7 580:-		8,5x20	16 300:-		
Breyton GTP M.Blk	10,5x21	7 644:-	10x20	17 600:-			
	8,5x19	5 256:-	9x21	18 900:-			
	9,5x19	5 460:-	10x21	20 200:-			
	8,5x20	5 768:-	Breyton BE GTS-AV H.Slv	8x17	3 688:-		
	10x20	6 252:-		8x18	3 880:-		
9x21	7 580:-	8,5x19		4 200:-			
10,5x21	7 644:-	9,5x19		4 456:-			
8,5x19	5 524:-	8,5x20		4 670:-			
Breyton Spirit R H.Slv	9,5x19	5 616:-	9x20	5 000:-			
	8,5x20	6 112:-	10x20	5 256:-			
	9,5x20	6 368:-	Breyton BE GTS-AV M.Gun	8x17	3 688:-		
	10x20	6 700:-		8x18	3 880:-		
	9x21	7 120:-		8,5x19	4 200:-		
10x21	7 248:-	9,5x19		4 456:-			
11,5x21	7 644:-	8,5x20		4 670:-			
Breyton Spirit R M.Gun	8,5x19	5 256:-	9x20	5 000:-			
	9,5x19	5 460:-	10x20	5 256:-			
	8,5x20	5 768:-	Breyton BE GTS-AV M.Blk	8x17	3 688:-		
	9,5x20	6 024:-		8x18	3 880:-		
	10x20	6 380:-		8,5x19	4 200:-		
9x21	6 788:-	9,5x19		4 456:-			
10x21	6 928:-	8,5x20		4 670:-			
Breyton Spirit R M.Blk	11,5x21	7 248:-	9x20	5 000:-			
	8,5x19	5 256:-	10x20	5 256:-			
	9,5x19	5 460:-	Breyton Force 4 H.Slv	7,5x17	3 944:-		
	8,5x20	5 768:-		8x17	4 000:-		
	9,5x20	6 024:-		8x18	4 148:-		
10x20	6 380:-	8,5x18		4 276:-			
9x21	6 788:-	8,5x19		4 670:-			
Breyton Spirit II H.Slv	10x21	6 928:-	9,5x19	4 670:-			
	11,5x21	7 248:-	8,5x20	5 320:-			
	8,5x19	6 700:-	9x20	5 512:-			
	9,5x19	6 900:-	10x20	5 768:-			
	8,5x20	6 800:-	Breyton Force 4 M.Gun	7,5x17	3 752:-		
10x20	7 452:-	8x17		3 880:-			
9x22	8 740:-	8x18		3 880:-			
10x22	9 348:-	8,5x18		4 008:-			
11,5x22	9 888:-	8,5x19		4 340:-			
Breyton Spirit II M.Gun	8,5x19	6 368:-	9,5x19	4 340:-			
	9,5x19	6 570:-	8,5x20	4 940:-			
	8,5x20	6 520:-	9x20	5 116:-			
	10x20	7 004:-	10x20	5 384:-			
	9x22	8 344:-	Breyton Force 4 M.Blk	7,5x17	3 752:-		
10x22	8 956:-	8x17		3 880:-			
11,5x22	9 492:-	8x18		3 880:-			
8,5x19	6 368:-	8,5x18		4 008:-			
9,5x19	6 570:-	8,5x19		4 340:-			
Breyton Spirit II M.Blk	8,5x20	6 520:-	9,5x19	4 340:-			
	10x20	7 004:-	8,5x20	4 940:-			
	9x22	8 344:-	9x20	5 116:-			
	10x22	8 956:-	10x20	5 384:-			
	11,5x22	9 492:-	Breyton Spirit 23 H.Slv	11x23	11 240:-		
8,5x19	6 368:-	Breyton Spirit 23 M.Gun		11x23	10 844:-		
9,5x19	6 570:-			Breyton Spirit 23 M.Blk	11x23	10 844:-	
8,5x20	6 520:-				Breyton Spirit RS Slv Forged Anodized	9x19	14 900:-
10x20	7 004:-					10x19	16 300:-
9x22	8 344:-		8,5x20			16 300:-	
10x22	8 956:-	10x20	17 600:-				
11,5x22	9 492:-						

Modell	Dim.	Pris brutto exkl. moms	Modell	Dim.	Pris brutto exkl. moms	
OZ Superforgiata	8,5x19	14 100:-	OZ Zeus (Hand Brushed)	8,5x20	18 000:-	
	9x19	14 200:-		9x20	18 100:-	
	10x19	14 300:-		9,5x20	18 200:-	
	11x19	14 500:-		10x20	18 300:-	
	12x19	14 700:-		10,5x20	18 400:-	
	8,5x20	15 400:-		11x20	18 500:-	
	9x20	15 500:-		11,5x20	18 700:-	
	10x20	15 600:-		12x20	18 800:-	
	11x20	15 800:-		8,5x21	20 900:-	
	11,5x20	15 900:-		9x21	21 000:-	
	12x20	16 000:-		10x21	21 200:-	
					10,5x21	21 400:-
					11x21	21 500:-
				11,5x21	21 700:-	
OZ Superforgiata (Ceramic Polished)	8,5x19	17 500:-		OZ Ares (Matt Black, Matt Dark Graphite, Grigio Corsa)	8x19	15 300:-
	9x19	17 600:-			8,5x19	15 400:-
	10x19	17 700:-			9x19	15 400:-
	11x19	17 900:-			9,5x19	15 500:-
	12x19	18 000:-			10x19	15 600:-
	8,5x20	18 800:-			10,5x19	15 700:-
	9x20	18 900:-			8,5x20	17 200:-
	10x20	19 000:-			9x20	17 300:-
	11x20	19 200:-			9,5x20	17 400:-
	11,5x20	19 300:-			10x20	17 500:-
	12x20	19 400:-			10,5x20	17 600:-
		11x20			17 700:-	
		11,5x20			17 800:-	
		12x20	17 900:-			
		8,5x21	20 100:-			
		9x21	20 200:-			
		10x21	20 400:-			
		10,5x21	20 500:-			
		11x21	20 600:-			
		11,5x21	20 800:-			
OZ Superforgiata Central Lock	8,5x19	14 700:-	OZ Ares (Ceramic Polished)	9x20	13 200:-	
	9x19	14 800:-		9,5x20	13 300:-	
	11x19	15 200:-		10x20	13 400:-	
	12x19	15 300:-		10,5x20	13 500:-	
	9x20	16 500:-		11x20	13 600:-	
	9,5x20	16 600:-		11,5x20	13 700:-	
11x20	16 900:-	12x20		15 700:-		
12x20	17 100:-	9x21		15 900:-		
		10x21		16 100:-		
		11x21				
		11,5x21				
Ny storlek!	11,5x21	22 400:-	Ares (Personal Colour tillägg per fälg)Extra		700:-	
	12,5x21	22 600:-				
OZ Superforgiata Central Lock (Ceramic Polished)	8,5x19	18 100:-	OZ Ares (Hand Brushed)	9x20	15 800:-	
	9x19	18 200:-		9,5x20	15 900:-	
	11x19	18 600:-		10x20	16 000:-	
	12x19	18 700:-		10,5x20	16 100:-	
Ny storlek!	8,5x20	19 700:-		11x20	16 200:-	
	9x20	19 900:-		11,5x20	16 300:-	
	9,5x20	20 000:-		9x21	18 300:-	
	11x20	20 300:-		10x21	18 500:-	
	12x20	20 500:-		11x21	18 700:-	
Ny storlek!	11,5x21	25 800:-		OZ Cortina G.Bik	9x19	3 628:-
Ny storlek!	12x21	26 000:-			10x19	3 712:-
					9,5x20	5 136:-
OZ Zeus (Matt Black, Matt Dark Graphite, Grigio Corsa)	8x19	12 700:-		OZ Montecarlo HLT G.Bik	8x19	3 712:-
	8,5x19	12 800:-	9x19		3 860:-	
	9x19	12 900:-	9,5x19		3 924:-	
	9,5x19	13 000:-	10x19		3 988:-	
	10x19	13 100:-				
	10,5x19	13 200:-				
	8,5x20	14 600:-				
	9x20	14 700:-				
	9,5x20	14 800:-				
	10x20	14 900:-				
	10,5x20	15 000:-				
	11x20	15 100:-				
	11,5x20	15 300:-				
	12x20	15 400:-				
	8,5x21	17 500:-				
	9x21	17 600:-				
	10x21	17 800:-				
10,5x21	18 000:-					
11x21	18 000:-					
11,5x21	18 300:-					
Zeus (Personal Colour tillägg per fälg)Extra		700:-				
OZ Zeus (Ceramic Polished)	8x19	16 100:-				
	8,5x19	16 200:-				
	9x19	16 300:-				
	9,5x19	16 400:-				
	10x19	16 500:-				
	10,5x19	16 600:-				

Modell	Dim.	Pris brutto exkl. moms	Modell	Dim.	Pris brutto exkl. moms
	8,5x20	5 136:-	Ultraleggera HLT CL Personal	EXTRA	580:-
	9,5x20	5 348:-	Color tillägg per fälg		
	10x20	5 456:-			
	10,5x20	5 560:-	OZ Ultraleggera HLT Matt Black	8x19	5 200:-
	11x20	5 668:-		8,5x19	5 284:-
	11,5x20	5 772:-		9x19	5 368:-
	9,5x22	6 920:-		9,5x19	5 456:-
OZ Superturismo Dakar	8,5x20	4 904:-		10x19	5 540:-
	10x20	5 244:-		11x19	5 752:-
	11x20	5 348:-		12x19	5 944:-
				8x20	5 988:-
OZ Superturismo Dakar HLT	9x21	6 200:-		8,5x20	6 092:-
	9,5x21	6 304:-		10x20	6 412:-
	10,5x21	6 516:-		11x20	6 624:-
	11x21	6 624:-		11,5x20	6 400:-
	11,5x21	6 728:-		12x20	6 836:-
	9x22	7 124:-	Ultraleggera HLT CL Personal	EXTRA	580:-
	9,5x22	7 240:-	Color tillägg per fälg		
	10x22	7 328:-			
	10,5x22	7 456:-	OZ Challenge HLT	8,5x18	5 180:-
	11x22	7 556:-		9x18	5 264:-
	11,5x22	7 656:-		9,5x18	5 392:-
OZ Rally Raid	8x17	2 948:-		10x18	5 496:-
	8,5x18	3 712:-		11x18	6 008:-
				12x18	6 644:-
				13x18	7 304:-
OZ Hyper XT HLT Gra/Pol	9x20	6 200:-	OZ Challenge HLT Central Lock	8,5x18	6 264:-
	9,5x20	6 304:-		9x18	6 348:-
	10x20	6 412:-		11x18	6 816:-
	10,5x20	6 516:-		12x18	7 476:-
	11x20	6 624:-	OZ Formula HLT	7x17	2 860:-
	11,5x20	6 428:-		7,5x17	2 884:-
	9x21	6 816:-		8x17	2 904:-
	9,5x21	6 920:-		8,5x17	2 924:-
	10x21	7 028:-		9x17	2 948:-
	10,5x21	7 136:-		7,5x18	3 480:-
	11x21	7 240:-		8x18	3 500:-
	11,5x21	7 348:-		9x18	3 544:-
	9x22	7 368:-		8,5x19	4 688:-
	9,5x22	7 476:-		9x19	4 796:-
	10x22	7 580:-		10x19	5 008:-
	10,5x22	7 688:-		11x19	5 220:-
	11x22	7 796:-	OZ Leggera HLT	7,5x17	3 180:-
	11,5x22	7 900:-		8x17	3 200:-
OZ Hyper XT HLT G.Blk	9x20	6 856:-		8x18	3 944:-
	9,5x20	6 964:-		8x19	4 968:-
	10x20	7 092:-		8,5x19	5 284:-
	10,5x20	7 196:-		9x19	5 368:-
	11x20	7 324:-		9,5x19	5 456:-
	11,5x20	7 432:-		10x19	5 540:-
	9x21	7 536:-		11x19	5 752:-
	9,5x21	7 644:-		12x19	5 944:-
	10x21	7 772:-		8x20	5 988:-
	10,5x21	7 896:-		8,5x20	6 092:-
	11x21	8 004:-		9x20	6 200:-
	11,5x21	8 132:-		10x20	6 412:-
	9x22	8 156:-		11x20	6 624:-
	9,5x22	8 260:-		12x20	6 836:-
	10x22	8 388:-		8,5x21	7 028:-
	10,5x22	8 496:-		9x21	7 136:-
	11x22	8 620:-		9,5x21	7 240:-
	11,5x22	8 748:-		11x21	7 432:-
OZ Hyper XT HLT Off Road	9x20	6 200:-		11,5x21	7 536:-
OZ Ultraleggera HLT	8,5x19	7 220:-	OZ Superturismo Aero	8x18	4 688:-
Central Lock Matt Black	9x19	7 260:-		8x19	5 900:-
	11x19	7 796:-		8,5x19	5 988:-
	12x19	8 092:-		9x19	6 072:-
	9x20	8 260:-		8,5x20	6 900:-
Ny storlek!	9,5x20	8 556:-		9x20	7 004:-
	11x20	8 812:-		9,5x20	7 112:-
	11,5x20	8 920:-		10x20	7 216:-
	12x20	9 000:-			
	12,5x21	10 900:-			

Modell	Dim.	Pris brutto exkl. moms	Modell	Dim.	Pris brutto exkl. moms	
OZ Hyper GT	10,5x20	7 324:-	OZ Superturismo WRC	6x14	1 736:-	
	11x20	7 432:-		6,5x15	1 948:-	
	11,5x20	7 536:-		7x16	2 116:-	
	7x17	3 076:-		7x17	2 628:-	
	7,5x17	3 096:-		8x17	2 628:-	
	7x18	3 756:-		7x18	3 224:-	
	7,5x18	3 776:-		OZ Superturismo GT	6x14	1 736:-
	8x18	3 796:-			6,5x15	1 948:-
	8x19	4 988:-			7x16	2 116:-
	8,5x19	5 072:-			7x17	2 628:-
	9x19	5 156:-			7,5x17	2 628:-
	9,5x19	5 244:-			8x17	2 628:-
	10x19	5 328:-			7x18	3 224:-
	8,5x20	5 772:-			8x18	3 264:-
	9x20	5 880:-			8x19	3 924:-
	9,5x20	5 988:-			OZ Superturismo LM	7x17
	10x20	6 092:-		7,5x17		2 840:-
	10,5x20	6 200:-		7,5x18		3 564:-
	11x20	6 304:-	8x18	3 584:-		
11,5x20	6 412:-	8,5x19	4 412:-			
12x20	6 516:-	9,5x19	4 648:-			
8x18	4 008:-	9x21	6 052:-			
8x19	5 328:-	10,5x21	6 432:-			
8,5x19	5 412:-	OZ Superturismo LM EVO	8x18	4 096:-		
9,5x19	5 584:-		8,5x19	4 968:-		
10x19	5 668:-		8,5x20	5 540:-		
11x19	5 752:-		OZ Ultraleggera	7x15	2 204:-	
8,5x20	6 200:-			7x16	2 544:-	
9x20	6 304:-	7x17		3 076:-		
9,5x20	6 412:-	7,5x17		3 096:-		
10x20	6 516:-	8x17		3 096:-		
11x20	6 428:-	7x18		3 756:-		
OZ Granturismo HLT	8,5x19	4 732:-		7,5x18	3 776:-	
	8,5x20	5 392:-		8x18	3 796:-	
	9x20	5 496:-		9x18	3 840:-	
	9,5x20	5 604:-		OZ Italia 150 Dimond Cut	7x17	2 628:-
	10x20	5 712:-	8x17		2 628:-	
	10,5x20	5 816:-	8x18		3 288:-	
11x20	5 924:-	8x19	3 924:-			
OZ Alleggerita HLT S.Siv	7x16	2 756:-	OZ Italia 150 G.Bik		7x17	2 544:-
	7x17	3 436:-		8x17	2 564:-	
	7,5x17	3 456:-		8x18	3 116:-	
	8x17	3 480:-		8x19	3 732:-	
	8,5x17	3 500:-		OZ Leggenda	7x17	2 820:-
	7x18	4 436:-				
	7,5x18	4 456:-				
	8x18	4 476:-				
	8,5x18	4 520:-				
	9x18	4 604:-				
	9,5x18	4 712:-				
	10x18	4 840:-				
	11x18	5 072:-				
	12x18	5 688:-				
	Alleggerita HLT Personal Color tillägg per fälg	EXTRA	580:-			
OZ Omnia	7,5x17	2 224:-				
	8x18	2 544:-				
OZ Veloce GT	7,5x17	2 500:-				
	8x18	2 800:-				
OZ Rally Racing	7x17	2 736:-				
	8x17	2 776:-				
	7,5x18	3 416:-				
	8x18	3 436:-				
	8x19	4 072:-				
	8,5x19	4 180:-				
OZ Rally Racing Van	7,5x18	3 604:-				
	8x18	3 628:-				

Modell	Dim.	Pris brutto exkl. moms	Modell	Dim.	Pris brutto exkl. moms
MSW 19	6X14	1 296:-	MSW 40 G.Blk/Pol	7x17	1 596:-
	6,5x15	1 444:-		8x18	1 796:-
	6,5x16	1 620:-		7,5x19	1 976:-
	7x16	1 572:-		8x19	1 976:-
	7,5x16	1 624:-		8,5x19	1 976:-
	7x17	1 704:-		9x19	2 076:-
	8x17	1 768:-		8,5x20	2 876:-
	8x18	2 012:-		9x20	2 876:-
MSW 22	5,5x14	1 300:-		10x20	2 996:-
	6x15	1 416:-		11x20	2 996:-
	6,5x16	1 540:-		MSW 40 Van	6,5x16
MSW 22	8x17	1 768:-		MSW 40 Van G.Blk/Pol	6,5x16
MSW 24	6,5X15	1 588:-	MSW 41 G.Blk	7,5x19	2 684:-
	7X16	1 796:-		8x19	2 740:-
	7,5X16	1 856:-		8,5x20	3 328:-
	7X17	1 988:-		9x20	3 392:-
	8X17	2 096:-		9,5x20	3 460:-
	8X18	2 368:-		10,5x20	3 560:-
	8x19	2 792:-	MSW 41 G.Blk/Pol	7,5x19	2 804:-
	9x19	2 872:-		8x19	2 844:-
MSW 25	6x15	1 540:-	8,5x20	3 448:-	
	7x16	1 764:-	9x20	3 516:-	
	7x17	1 952:-	9,5x20	3 656:-	
	7,5x17	2 004:-	10,5x20	3 688:-	
	8X17	2 056:-	MSW 42 G.Blk	7,5x17	2 040:-
	8X18	2 352:-		8x18	2 344:-
	8,5x18	2 404:-		8x19	2 640:-
	9X18	2 428:-	MSW 42 G.Blk/Pol	7,5x17	2 120:-
8X19	2 732:-	8x18		2 452:-	
9X19	2 808:-	8x19		2 740:-	
MSW 27	7,5x17	2 004:-	MSW 46	7,5x17	2 348:-
Dark Titanium Full Polished	7,5x18	2 296:-		MSW 47 Matt Dark Titanium Full Polished	7,5x17
MSW 27 Gloss Black	7,5x17	1 956:-	8x18		2 572:-
	7,5x18	2 248:-	8x19		2 980:-
MSW 27T Gloss Black Full Polished	8,5x18	1 788:-	9x19		3 064:-
MSW 27T Gloss Black	8,5x18	1 696:-	MSW 48 Blk/Pol	6,5x16	1 952:-
MSW 27T Gloss Dark Grey	8,5x8	1 696:-		7,5x17	2 236:-
MSW 29	7,5x17	2 300:-		8x18	2 636:-
	8x18	2 692:-		8x19	3 016:-
	8x19	3 084:-		9x19	3 096:-
	8,5x19	3 124:-		6,5x20	2 484:-
MSW 30 G.Blk/Pol	7,5x17	1 496:-		8,5x20	3 368:-
	7,5x18	1 796:-		9,5x20	3 464:-
	8x18	1 796:-		9x21	4 056:-
	8,5x18	1 796:-		9,5x21	4 112:-
	9x18	1 796:-		10x21	4 012:-
	7,5x19	1 976:-		11,5x21	4 292:-
	8x19	1 976:-	MSW 48 M.Blk	6,5x16	1 396:-
	8,5x19	1 976:-		7,5x17	1 696:-
	9x19	1 976:-		8x18	2 016:-
	9,5x19	2 076:-		8x19	2 368:-
8,5x20	2 376:-	9x19		2 440:-	
9,5x20	2 396:-	6,5x20		2 048:-	
MSW 40 G.Gun	7x17	1 976:-		8,5x20	2 796:-
	8x18	2 280:-		9,5x20	2 896:-
	7,5x19	2 496:-		9x21	3 456:-
	8x19	2 548:-		9,5x21	3 496:-
	8,5x19	2 572:-		10x21	3 544:-
	9x19	2 596:-		11,5x21	3 668:-
	8,5x20	3 220:-	MSW 48 Van Blk/Pol	6,5x16	1 496:-
	9x20	3 264:-		7x16	1 496:-
	10x20	3 364:-		7x17	1 652:-
	11x20	3 476:-			

Modell	Dim.	Pris brutto exkl. moms	Modell	Dim.	Pris brutto exkl. moms
MSW 48 Van Blk/Pol 6H	6,5x16	1 496:-		8,5x19	2 664:-
MSW 48 Van	6,5x16	1 416:-		9x19	2 692:-
	7x16	1 416:-		8,5x20	3 172:-
	7x17	1 580:-		9x20	3 232:-
MSW 48 Van 6H	6,5x16	1 416:-		9,5x20	3 296:-
				10,5x20	3 388:-
MSW 49 M.Gun/Pol	8x18	2 136:-	MSW 74 G.Blk/Pol	8x18	2 452:-
	8x19	2 556:-		8,5x18	2 488:-
	9x19	2 628:-		8x19	2 740:-
	8,5x20	2 880:-		8,5x19	2 772:-
MSW 49 M.Gun	8x18	2 592:-		9x19	2 796:-
	8x19	2 952:-		8,5x20	3 184:-
	9x19	3 040:-		9x20	3 344:-
	8,5x20	3 316:-		9,5x20	3 408:-
MSW 50 M.Gun/Pol	8x18	2 644:-	MSW 77	5x14	732:-
	8x19	2 988:-		6x15	840:-
	8,5x19	3 028:-		7x16	972:-
	8,5x20	3 336:-		7,5x17	1 200:-
	9,5x20	3 432:-		8x18	1 396:-
	8,5x21	3 944:-	MSW 78	6,5x16	1 524:-
MSW 50 G.Blk	8x18	1 896:-		6,5x17	1 644:-
	8x19	2 200:-	MSW 79 D.Grey	6,5x16	1 580:-
	8,5x19	2 200:-		7x17	1 812:-
	8,5x20	2 476:-		7x18	1 932:-
	9,5x20	2 476:-		7,5x18	1 956:-
	8,5x21	3 024:-	MSW 79 G.Blk/Pol	6,5x16	1 156:-
MSW 55 Silver	6,5x16	1 536:-		7x17	1 356:-
	7,5x17	1 788:-		7x18	1 456:-
	8,5x18	2 060:-		7,5x18	1 456:-
	8,5x19	2 224:-	MSW 82 M.Gun/Pol	8x18	2 288:-
MSW 55 Van Silver	7x17	1 828:-		9x18	2 356:-
MSW 55 D.Grey	6,5x16	952:-		8x19	2 644:-
	7,5x17	1 236:-		9x20	3 244:-
	8,5x18	1 496:-	MSW 82	8x18	2 240:-
	8,5x19	1 728:-		9x18	2 312:-
MSW 55 Van D.Grey	7x17	1 268:-		8x19	2 548:-
MSW 71 D.Grey/Pol	7,5x17	2 068:-		9x20	3 132:-
	8x18	2 384:-		6x14	1 100:-
	8x19	2 644:-		6x15	1 100:-
	8,5x19	2 672:-		6,5x16	1 264:-
MSW 71 G.Blk	7,5x17	1 992:-		7x17	1 416:-
	8x18	2 280:-		8x18	2 052:-
	8x19	2 548:-	MSW 86 G.Blk/Pol	6x15	1 544:-
	8,5x19	2 572:-		6,5x16	1 728:-
MSW 72	7x17	1 856:-		7,5x17	1 980:-
	8x18	2 084:-		7,5x18	2 260:-
MSW 73 D.Grey/Pol	7,5x17	1 928:-	MSW 86 Silver	6x15	1 504:-
	8x18	2 208:-		6,5x16	1 688:-
	8,5x18	2 240:-		7,5x17	1 944:-
	8x19	2 444:-		7,5x18	2 228:-
	8,5x19	2 468:-	MSW X2	5,5x15	1 576:-
	9x19	2 496:-		6,5x15	1 576:-
MSW 73 D.Grey	7,5x17	1 856:-	MSW X4 G.Blk/Pol	5,5x14	1 484:-
	8x18	2 112:-		5x15	1 568:-
	8,5x18	2 120:-		5,5x15	1 568:-
	8x19	2 356:-		6x16	1 744:-
	8,5x19	2 376:-		7x16	1 744:-
	9x19	2 400:-	MSW X4 M.Blk	5,5x14	1 436:-
MSW 74 G.Blk	8x18	2 344:-		5x15	1 516:-
	8,5x18	2 352:-		5,5x15	1 516:-
	8x19	2 640:-		6x16	1 672:-
				7x16	1 672:-

Modell	Dim.	Pris brutto exkl. moms	Modell	Dim.	Pris brutto exkl. moms	
Beyern Antler Silver/Mirror Cut Face	8x17	4 916:-	Mirror Cut Face	9x17	4 916:-	
	9x17	4 916:-		8,5x18	5 440:-	
	8,5x18	5 440:-		9x18	5 440:-	
	9x18	5 440:-		9,5x18	5 440:-	
	9,5x18	5 440:-		10x18	5 440:-	
	10x18	5 440:-		8,5X19	6 124:-	
	8,5X19	6 124:-		9X19	6 124:-	
	9X19	6 124:-		9,5X19	6 124:-	
	9,5X19	6 124:-		10,5x20	6 700:-	
	10x19	6 124:-		10x22	7 800:-	
	9x20	6 700:-		11x22	7 800:-	
	10x20	6 700:-				
	10,5x20	6 700:-		Beyern Gerade Matte Black	9,5X19	6 124:-
	9x22	7 800:-			9x20	6 700:-
	10x22	7 800:-			10x20	6 700:-
10,5x22	7 800:-					
11x22	7 800:-					
Beyern Antler Double Black - Matte Black/ Gloss Black Face	8x17	4 916:-	Beyern Mesh Chrome	7x15	4 968:-	
	9x17	4 916:-		7x17	5 596:-	
	8,5x18	5 440:-		8x17	5 596:-	
	9x18	5 440:-		8,5x18	6 964:-	
	9,5x18	5 440:-		9,5x18	6 964:-	
	10x18	5 440:-		8,5X19	7 700:-	
	8,5X19	6 124:-		9,5X19	7 700:-	
	9X19	6 124:-		8,5x20	8 536:-	
	9,5X19	6 124:-		10x20	8 536:-	
	10x19	6 124:-		9,5x22	10 320:-	
	9x20	6 700:-		11x22	10 320:-	
	10x20	6 700:-				
	10,5x20	6 700:-		Beyern Mesh Gloss^r Black/Mirror Cut Lip	7x15	3 448:-
	9x22	7 800:-			7x17	4 024:-
	10x22	7 800:-			8x17	4 024:-
10,5x22	7 800:-		8,5x18	4 548:-		
11x22	7 800:-		9,5x18	4 548:-		
			8,5X19	5 232:-		
			9,5X19	5 232:-		
			8,5x20	5 808:-		
			10x20	5 808:-		
			9,5x22	7 384:-		
			11x22	7 384:-		
Beyern Autobahn Gloss Gunmetal	8x17	3 080:-	Beyern Mesh Silver/Mirror Cut Lip	7x15	3 448:-	
	8,5x18	3 516:-		7x17	4 024:-	
	9,5x18	3 516:-		8x17	4 024:-	
	8,5X19	3 984:-		8,5x18	4 548:-	
	9,5X19	3 984:-		9,5x18	4 548:-	
	9x20	4 300:-		8,5X19	5 232:-	
	10x20	4 300:-		9,5X19	5 232:-	
	9x22	5 200:-		8,5x20	5 808:-	
	9x22	5 200:-		10x20	5 808:-	
	10,5x22	5 200:-		9,5x22	7 384:-	
			11x22	7 384:-		
Beyern Autobahn Matte Black	8x17	3 080:-	Beyern Multi Chrome	8x17	5 596:-	
	8,5x18	3 516:-		8,5x18	6 964:-	
	9,5x18	3 516:-		9,5x18	6 964:-	
	8,5X19	3 984:-		8,5X19	7 700:-	
	9,5X19	3 984:-		9,5X19	7 700:-	
	9x20	4 300:-		8,5x20	8 536:-	
	10x20	4 300:-		10x20	8 536:-	
	9x22	5 200:-		9,5x22	10 320:-	
	9x22	5 200:-		11x22	10 320:-	
	10,5x22	5 200:-				
Beyern Aviatic Silver/ Mirror Cut Face	8x17	4 024:-	Beyern Multi Silver/Mirror Cut Lip	8x17	4 024:-	
	8,5x18	4 548:-		8,5x18	4 548:-	
	9,5x18	4 548:-		9,5x18	4 548:-	
	8,5X19	5 232:-		8,5X19	5 232:-	
	9,5X19	5 232:-		9,5X19	5 232:-	
	9x20	5 808:-		8,5x20	5 808:-	
			10x20	5 808:-		
			9,5x22	7 384:-		
			11x22	7 384:-		
Beyern Aviatic Matte Gunmetal/Gloss Black Lip	10x20	5 808:-	Beyern Rapp Chrome	8x17	5 596:-	
	8x17	4 024:-		8,5x18	6 964:-	
	8,5x18	4 548:-		9,5x18	6 964:-	
	9,5x18	4 548:-				
	8,5X19	5 232:-				
	9,5X19	5 232:-				
9x20	5 808:-					
10x20	5 808:-					
Beyern Gerade Silver/	8x17	4 916:-				

Modell	Dim.	Pris brutto exkl. moms	Modell	Dim.	Pris brutto exkl. moms
	8,5X19	7 700:-		9,5X19	6 124:-
	9,5X19	7 700:-		9x20	6 700:-
	8,5x20	8 536:-		10x20	6 700:-
	10x20	8 536:-			
	9x22	10 320:-	Beyern Spartan Matte Black	8x17	4 916:-
	10,5x22	10 320:-		9x17	4 916:-
Beyern Rapp Gloss Black/ Mirror Cut Lip	8x17	4 024:-		8,5x18	5 440:-
	8,5x18	4 548:-		9,5x18	5 440:-
	9,5x18	4 548:-		8,5X19	6 124:-
	8,5X19	5 232:-		9,5X19	6 124:-
	9,5X19	5 232:-		9x20	6 700:-
	8,5x20	5 808:-		10x20	6 700:-
	10x20	5 808:-	Black Rhino Abrams Gloss Gunblack/Machined Dark Tint Lip	9,5x17	4 624:-
	9x22	7 384:-		9,5x18	4 920:-
	10,5x22	7 384:-		9,5x20	5 512:-
Beyern Rapp Silver/Mirror Cut Lip	8x17	4 024:-	Black Rhino Abrams Textured Matte Gunmetal	9,5x17	4 484:-
	8,5x18	4 548:-		9,5x18	4 728:-
	9,5x18	4 548:-		9,5x20	5 264:-
	8,5X19	5 232:-	Black Rhino Abrams Olive Drab Green	9,5x17	4 720:-
	9,5X19	5 232:-		9,5x18	5 064:-
	8,5x20	5 808:-		9,5x20	5 664:-
	10x20	5 808:-	Black Rhino Alamo Matte Black/ Black Bolts	9x17	4 252:-
	9x22	7 384:-		9x18	4 540:-
	10,5x22	7 384:-		9x20	5 208:-
Beyern Ritz Gloss Black	8x17	4 916:-	Black Rhino Alamo Gloss Black/ Machined Face and Stainless Bolts	9x17	4 348:-
	9x17	4 916:-		9x18	4 636:-
	8,5x18	5 440:-		9x20	5 304:-
	9,5x18	5 440:-	Black Rhino Alamo Silver/ Mirror Face and Stainless Bolts	9x17	4 348:-
	10x18	5 440:-		9x18	4 636:-
	8,5X19	6 124:-		9x20	5 304:-
	9X19	6 124:-	Black Rhino Apache Matte Black/ Black Bolts	8,5x17	3 920:-
	9,5X19	6 124:-		9x18	4 252:-
	10x19	6 124:-		9x20	4 728:-
	9x20	6 700:-	Black Rhino Apache Matte Bronze/ Black Lip Edge and Black Bolts	8,5x17	4 156:-
	10x20	6 700:-		9x18	4 492:-
	10,5x20	6 700:-		9x20	4 968:-
	9x22	7 800:-	Black Rhino Arches Matte Black	7x15	3 396:-
	10x22	7 800:-		8x17	3 920:-
	10,5x22	7 800:-		8x18	4 108:-
	11x22	7 800:-		8X19	4 444:-
Beyern Ritz Gloss Gunmetal/ Brushed Face	8x17	4 916:-	Black Rhino Arches Matte Brushed Gunmetal/Black Bolts	7x15	3 776:-
	9x17	4 916:-		8x17	4 348:-
	8,5x18	5 440:-		8x18	4 588:-
	9,5x18	5 440:-		8X19	4 828:-
	10x18	5 440:-	Black Rhino Arches Matte Bronze/ Black Lip Edge and Black Bolts	8X19	4 636:-
	8,5X19	6 124:-		7x15	3 632:-
	9X19	6 124:-		8x17	4 156:-
	9,5X19	6 124:-		8x18	4 396:-
	10x19	6 124:-	Black Rhino Ark Matte Black	8,5x17	3 920:-
	9x20	6 700:-		9x18	4 252:-
	10x20	6 700:-		9x20	4 968:-
	10,5x20	6 700:-	Black Rhino Ark Bronze/ Gloss Black Bolt	8,5x17	3 920:-
	9x22	7 800:-		9x18	4 252:-
	10x22	7 800:-		9x20	4 968:-
	10,5x22	7 800:-	Black Rhino Armory Desert Sand	8x16	3 824:-
	11x22	7 800:-		8x17	3 920:-
Beyern Spartan Chrome	8x17	6 228:-		9,5x17	3 920:-
	9x17	6 228:-		9,5x18	4 496:-
	8,5x18	7 700:-		9,5x20	5 076:-
	9,5x18	7 700:-		12x20	5 284:-
	8,5X19	8 432:-			
	9,5X19	8 432:-			
	9x20	9 272:-			
	10x20	9 272:-			
Beyern Spartan Hyper Silver	8x17	4 916:-			
	9x17	4 916:-			
	8,5x18	5 440:-			
	9,5x18	5 440:-			
	8,5X19	6 124:-			

Modell	Dim.	Pris brutto exkl. moms	Modell	Dim.	Pris brutto exkl. moms
Black Rhino Armory Matte Gunblack	8x16	3 824:-	Black Rhino Bantam Bronze	8x16	3 604:-
	8x17	3 920:-		8,5x17	4 236:-
	9,5x17	3 920:-		9x18	5 020:-
	9,5x18	4 496:-	Black Rhino Barstow Dearborn Blue/Black Lip Edge	9,5x17	4 252:-
	9,5x20	5 076:-		9,5x18	4 828:-
	12x20	5 284:-	9,5x20	5 396:-	
Black Rhino Armory UTV Desert Sand	7x14	3 012:-	Black Rhino Barstow Textured Matte Black	8x17	3 868:-
	7x15	3 204:-		9,5x17	4 024:-
Black Rhino Armory UTV Matte Gunblack	7x14	3 012:-	8x18	4 444:-	
	7x15	3 204:-	9,5x18	4 600:-	
Black Rhino Arsenal Sand on Black	8x16	3 708:-	8,5x20	5 076:-	
	8x17	3 920:-	9,5x20	5 180:-	
	9,5x17	4 024:-	12x20	5 388:-	
	8x18	4 396:-	Black Rhino Arsenal	8x16	3 708:-
	9,5x18	4 600:-		8x17	3 920:-
	8,5x20	5 076:-		9,5x17	4 024:-
9,5x20	5 180:-	8x18		4 396:-	
12x20	5 388:-	9,5x18		4 600:-	
			8,5x20	5 076:-	
			9,5x20	5 180:-	
			12x20	5 388:-	
Black Rhino Asagai Matte Black/Machined Spoke and Stainless Bolts	8,5x17	4 108:-	Black Rhino Blaster Gloss Black/ Milled Spokes Left	14x22	8 452:-
	9,5x18	4 444:-		14x24	8 928:-
	9,5x20	5 064:-	Black Rhino Blaster Gloss Black/ Milled Spokes Right	14x22	8 452:-
				14x24	8 928:-
Black Rhino Attica Matte Black/Black Bolts	9x17	4 024:-	Black Rhino Blaster Polished Left	14x22	8 928:-
	9,5x18	4 600:-		14x24	9 404:-
	9,5x20	5 180:-	Black Rhino Blaster Polished Right	14x22	8 928:-
Black Rhino Attica Matte Bronze/ Black Lip Edge and Brass Bolts	9x17	4 024:-		14x24	9 404:-
	9,5x18	4 600:-		Black Rhino Boxer Gloss Gold	7x15
9,5x20	5 180:-	7x16			3 656:-
Black Rhino Axle Matte Black	9,5x17	4 076:-			8x17
	9,5x18	4 396:-	8,5x17		3 868:-
	9,5x20	5 112:-	8x18	4 340:-	
Black Rhino Axle Gloss White	9,5x17	4 076:-	8,5x18	4 340:-	
	9,5x18	4 396:-	Black Rhino Boxer Gunblack	7x15	3 448:-
	9,5x20	5 112:-		7x16	3 656:-
Black Rhino Baker Matte Black	8,5x17	3 316:-		8x17	3 868:-
	9x18	3 592:-	8,5x17	3 868:-	
	9x20	3 868:-	8x18	4 340:-	
Black Rhino Baker Matte Bronze/ Black Lip Edge and Black Bolts	8,5x17	3 552:-	8,5x18	4 340:-	
	9x18	3 908:-	Black Rhino Bullhead Matte Black	9x17	3 488:-
	9x20	4 220:-		9x18	3 776:-
Black Rhino Bandolier Matte Black	8x16	3 488:-		9,5x20	4 444:-
	8x17	3 680:-	Black Rhino Centurion Gloss Black/Milled Spokes	10x20	8 452:-
	Black Rhino Bandolier Matte Bronze	8x16		3 488:-	12x22
8x17		3 680:-		14x22	10 840:-
Black Rhino Bandolier Gloss Gunmetal	8x16	3 488:-		14x24	11 800:-
	8x17	3 680:-	Black Rhino Centurion Polished	10x20	8 928:-
Black Rhino Bantam Textured Black	8x16	3 604:-		12x22	9 880:-
	8,5x17	4 236:-		14x22	11 800:-
	9x18	5 020:-		14x24	12 740:-
Black Rhino Bantam Olive Drab Green	8x16	3 604:-	Black Rhino Chamber Matte Black	8x16	3 300:-
	8,5x17	4 236:-		8,5x17	3 536:-
	9x18	5 020:-		9,5x18	3 920:-
			9,5x20	4 492:-	
			Black Rhino Chamber Matte Gold	8,5x17	3 536:-
				9,5x20	4 492:-
			Black Rhino Chase Brushed Gunmetal	8x17	4 340:-
				8,5x17	4 340:-
				9x17	4 340:-
				9,5x17	4 340:-

Modell	Dim.	Pris brutto exkl. moms	Modell	Dim.	Pris brutto exkl. moms
	8x18	4 968:-	Black Rhino Everest Silver/ Mirror Cut Face	9x20 9,5x22 10x24	4 708:- 5 860:- 6 964:-
	8,5x18	4 968:-			
	9x18	4 968:-			
	9,5x18	4 968:-	Black Rhino Excursion Gloss Black/Mirror Face	7,5x16 7,5x17 8x18	3 728:- 3 920:- 4 396:-
	8,5x20	5 808:-			
	9x20	5 808:-			
	9,5x20	5 808:-			
Black Rhino Chase Matte Black	8x17	4 340:-	Black Rhino Excursion Matte Black	7,5x16 7,5x17 8x18	3 584:- 3 776:- 4 252:-
	8,5x17	4 340:-			
	9x17	4 340:-			
	9,5x17	4 340:-			
	8x18	4 968:-	Black Rhino Faction Matte Black/ Machined Tint and Rock Guard	8x16 8x17	4 920:- 5 208:-
	8,5x18	4 968:-			
	9x18	4 968:-			
	9,5x18	4 968:-	Black Rhino Faction Matte Black/Black Rock Guard	8x16 8x17	4 828:- 5 112:-
	8,5x20	5 808:-			
	9x20	5 808:-	Black Rhino Faction OD Green/ Black Rock Guard	8x16 8x17	4 828:- 5 112:-
	9,5x20	5 808:-			
Black Rhino Cinco Gloss Black/ Stainless Bolt	9,5x17	4 024:-	Black Rhino Faro Metallic Black	9x20 10x22 10x24	4 812:- 5 016:- 5 876:-
	9,5x18	4 600:-			
	9,5x20	5 180:-			
Black Rhino Cinco Bronze/Black Bolts	9,5x17	4 024:-	Black Rhino Fury PVD/ Stainless Bolts	9,5x20 11,5x20 11,5x22	7 020:- 7 212:- 7 784:-
	9,5x18	4 600:-			
	9,5x20	5 180:-			
Black Rhino Cleghorn Matte Black	8,5x17	3 632:-	Black Rhino Fury Gloss Black	9,5x17 9,5x18 9,5x20 11,5x20 11,5x22	4 024:- 4 600:- 5 180:- 5 388:- 5 588:-
	9x18	4 024:-			
	9x20	4 588:-			
Black Rhino Coyote Gloss Black/ Machined Face and Stainless Bolts	9x17	4 252:-	Black Rhino Fury Matte Gunmetal	9,5x17 9,5x18 9,5x20 11,5x20 11,5x22	4 024:- 4 600:- 5 180:- 5 388:- 5 588:-
	9x18	4 540:-			
	9x20	5 208:-			
Black Rhino Crawler Matte Black	9,5x17	4 128:-	Black Rhino Garrison Beadlock Desert/Matte Black Lip Ring	8,5x17	5 704:-
	9,5x18	4 708:-			
	9,5x20	5 284:-	Black Rhino Garrison Beadlock Matte Black	8,5x17	5 704:-
Black Rhino Crawler Matte Bronze/Black Lip Ring	9,5x17	4 128:-	Black Rhino Gauntlet Gloss Black/ Mirror Machined Lip Edge	8,5x17 9x18 9x20	4 208:- 4 588:- 5 064:-
	9,5x18	4 708:-			
	9,5x20	5 284:-	Black Rhino Gauntlet Semi Gloss Black/Gunmetal Bolt	8,5x17 9x18 9x20	4 024:- 4 396:- 4 876:-
Black Rhino Crawler Beadlock Matte Black	8,5x17	5 704:-	Black Rhino Glamis Matte Black	9x17 9x18 9x20 12x20 14x22	3 604:- 4 128:- 4 708:- 5 284:- 6 648:-
Black Rhino Crawler Beadlock Silver/Mirror Face and Black Lip Ring	8,5x17	5 704:-	Black Rhino Grange Matte Black/ Machined Tint Ring	8,5x17 9x18 9x20	3 920:- 4 396:- 5 064:-
Black Rhino Crawler Beadlock Matte Bronze/Black Lip	8,5x17	5 704:-	Black Rhino Gravel Beadlock Matte Black/Machined Ring and Black Bolts	7x15	5 304:-
Black Rhino Crawler Beadlock Silver/Mirror Face and Black Lip Ring	8,5x17	5 704:-	Black Rhino Gravel Beadlock Gold/ Black Ring and Bolts	7x15	5 304:-
Black Rhino Crawler Beadlock Matte Bronze/Black Lip Ring	8,5x17	5 704:-	Black Rhino Gravel Beadlock Matte Black	7x15	5 304:-
Black Rhino Destroyer Desert Sand	6x16	3 972:-	Black Rhino Gravel Beadlock Gloss White/Black Ring and Black Bolts	7x15	5 304:-
Black Rhino Destroyer Matte Gunmetal	6x16	3 972:-			
Black Rhino Destroyer Textured Matte Black	6x16	4 396:-			
Black Rhino Dugger Gun Black	8x16	4 636:-			
	8,5x17	4 916:-			
	8,5x18	5 388:-			
	9x20	6 124:-			
Black Rhino Everest Matte Black	9x20	4 708:-			
	9,5x22	5 860:-			
	10x24	6 964:-			

Modell	Dim.	Pris brutto exkl. moms	Modell	Dim.	Pris brutto exkl. moms
Black Rhino GrimlockGloss Black/Milled Spokes	9,5x20 11,5x20 11,5x22 14x22 14x24	5 972:- 6 352:- 7 448:- 7 688:- 8 832:-	Black Rhino Kelso Battleship Gray/ Black Lip Edge and Black Bolts	9x17 9x20	4 300:- 5 256:-
Black Rhino Hachi Bronze	8x16	3 488:-	Black Rhino:-uger Gloss Black	8,5x18 9x20 9,5x22 10x24	4 340:- 5 076:- 6 124:- 6 964:-
Black Rhino Haka Gloss Black/ Milled Spokes	8,5x20 9,5x22	4 864:- 6 072:-	Black Rhino kruger Gloss Gunmetal	8,5x18 9x20 9,5x22 10x24	4 340:- 5 076:- 6 124:- 6 964:-
Black Rhino Haka Matte Black	8,5x20 9,5x22	4 864:- 6 072:-	Black Rhino kruger Silver/ Mirror Cut Face	9x20 9,5x22 10x24	5 076:- 6 124:- 6 964:-
Black Rhino Havasu Matte Black	8x18	4 444:-	Black Rhino Kunene Gloss Black	9x20 9,5x22 10x24	5 076:- 6 124:- 6 964:-
Black Rhino Henderson Matte Black/Brass Bolts	9x17 9x18 9,5x20	4 024:- 4 396:- 4 876:-	Black Rhino Kunene Silver/ Mirror Cut Face	9x20 9,5x22 10x24	5 076:- 6 124:- 6 964:-
Black Rhino Henderson Gun Black/ Black Lip Edge and Black Bolts	9x17 9x18 9,5x20	4 252:- 4 636:- 5 208:-	Black Rhino Kunene Matte Black/ Dark Tint Milled Spokes	9x20 9,5x22 10x24	5 076:- 6 124:- 6 964:-
Black Rhino Henderson OD Green/ Black Lip Edge and Black Bolts	9x17 9x18 9,5x20	4 252:- 4 636:- 5 208:-	Black Rhino Madagascar Matte Black	9x20 9,5x22 10x22 10,5x22 10x24	4 920:- 5 876:- 5 972:- 6 064:- 6 972:-
Black Rhino Highland Matte Black	9,5x17 9,5x18 9,5x20	4 024:- 4 600:- 5 180:-	Black Rhino Marauder Gloss Black/Milled Spokes	14x22 14x24	9 880:- 10 360:-
Black Rhino Hollister Bronze	9,5x17 9,5x18 9,5x20	4 156:- 4 540:- 5 016:-	Black Rhino Marauder Polished	14x22 14x24	10 360:- 10 840:-
Black Rhino HollisterGloss Black/Milled Spokes	9,5x17 9,5x18 9,5x20	4 636:- 5 016:- 5 496:-	Black Rhino Mesa Gloss Black	8,5x17 9x18 9x20	3 776:- 4 024:- 4 444:-
Black Rhino Horus Polished	14x22 14x24	9 880:- 10 840:-	Black Rhino Mesa Matte Black/ Machined Face	8,5x17 9x18 9x20	3 872:- 4 108:- 4 636:-
Black Rhino HorusGloss Black/ Milled Spokes	14x24	10 360:-	Black Rhino Midhill Matte Gunmetal/ Black Bolts	8x16 8x17 8x18	4 076:- 4 348:- 4 728:-
Black Rhino Journey Gloss Gunmetal/Mirror Cut Face	7,5x16 7,5x17 8x18	3 816:- 4 024:- 4 444:-	Black Rhino Midhill Matte Black/ Gunmetal Bolts	8x16 8x17 8x18	4 076:- 4 348:- 4 728:-
Black Rhino Journey Matte Black	7,5x16 7,5x17 8x18	3 816:- 4 024:- 4 444:-	Black Rhino Mission Matte Black/ Machined Tinted Spokes	8,5x17 9x18 9x20 11,5x20	4 108:- 4 492:- 5 304:- 5 540:-
Black Rhino Karoo Gloss Gunmetal	9,5x20 10x22 10x24	4 864:- 5 912:- 6 856:-	Black Rhino Morocco Gloss Black	8,5x18 9x20 10x22 10x24	3 920:- 4 540:- 5 208:- 6 352:-
Black Rhino Karoo Matte Black	9,5x20 10x22 10x24	4 864:- 5 912:- 6 856:-	Black Rhino Mozambique Gloss Black/Milled Spokes	8,5x18 8,5x20 9,5x22 10x24	4 708:- 5 388:- 6 544:- 7 644:-
Black Rhino Katavi Gloss Black	9x20 10x22 10x24	5 076:- 6 124:- 6 964:-	Black Rhino Mozambique Matte Black	8,5x18 8,5x20 9,5x22 10x24	4 708:- 5 388:- 6 544:- 7 644:-
Black Rhino Katavi Silver/ Mirror Cut Face and Lip	9x20 10x22 10x24	5 076:- 6 124:- 6 964:-			
Black Rhino Kelso Matte Black/Black Bolts	9x17 9x18 9x20	4 076:- 4 492:- 4 968:-			

Modell	Dim.	Pris brutto exkl. moms	Modell	Dim.	Pris brutto exkl. moms	
Black Rhino MozambiqueSilver/ Mirror Cut Face	8,5x18	4 708:-	Black Rhino Primm Beadlock Candy Red/Black Ring and Black Bolts	8,5x17	6 544:-	
	8,5x20	5 388:-		Black Rhino Primm Beadlock Matte Black/Black Bolts	8,5x17	6 448:-
	9,5x22	6 544:-	Black Rhino Primm Beadlock Silver/Mirror Face and Machined Ring		8,5x17	6 640:-
	10x24	7 644:-		Black Rhino Primm Beadlock Matte Gold/Machined Ring and Black Bolts	8,5x17	6 448:-
Black Rhino Oceano Gloss Gunblack/Stainless Bolts	9,5x17	3 972:-	Black Rhino Rampage Gloss Black/Milled Spoke		9,5x20	5 352:-
	9,5x18	4 348:-		Black Rhino Rampage Gloss Black/Red Milled Spokes	12x20	5 496:-
	9,5x20	4 684:-	Black Rhino Rampage Gloss Black/Blue Milled Spokes		9,5x20	5 732:-
	12x20	5 160:-		Black Rhino Rampage Gloss Black/Red Milled Spokes	12x20	5 876:-
Black Rhino Oceano Matte Bronze/ Black Lip Edge	9,5x17	4 252:-	Black Rhino Ravine Matte Black		8,5x17	4 208:-
	9,5x18	4 684:-		9x18	4 492:-	
Black Rhino OdessaMatte Black/ Machined Tinted Lip and Milled Rings	9,5x20	5 064:-	9x20	5 064:-		
	12x20	5 540:-	Black Rhino Raze Matte Black	10x17	4 236:-	
	Black Rhino Odessa Matte Black	9,5x17		4 444:-	10x18	4 864:-
		9,5x18		4 728:-	12x20	5 388:-
9,5x20	5 496:-	14x22		6 648:-		
Black Rhino Overland Matte Black	8x17	3 920:-	14x24	7 592:-		
	9,5x17	4 024:-	Black Rhino Realm Semi Gloss Black	8x16	3 396:-	
	8x18	4 444:-		9,5x17	3 872:-	
	9,5x18	4 548:-		9,5x18	4 252:-	
9,5x20	4 968:-	9,5x20		4 636:-		
Black Rhino Peak Gloss Black/ Mirror Cut Face	9x20	5 496:-	Black Rhino Reaper Gloss Black/ Milled Spokes	9,5x20	5 972:-	
	9,5x22	6 492:-		11,5x20	6 352:-	
Black Rhino Peak Matte Black	9x20	5 496:-		11,5x22	7 404:-	
	9,5x22	6 492:-		14x22	7 784:-	
Black Rhino Pinatubo Gloss Black/Milled Inside Window	9,5x17	4 024:-	14x24	9 216:-		
	9,5x18	4 600:-	Black Rhino Recon Candy Red	9,5x17	4 004:-	
	9,5x20	5 180:-		9,5x18	4 396:-	
	12x20	5 388:-		9,5x20	4 728:-	
12x22	6 648:-	Black Rhino Recon Textured Gunmetal		9,5x17	3 908:-	
Black Rhino Pinnacle Semi Gloss Black/Gunmetal BoltS	8,5x17		4 252:-	9,5x18	4 252:-	
	9x18		4 444:-	9,5x20	4 560:-	
9x20	4 876:-		Black Rhino Recon Matte Black	9,5x17	3 908:-	
Black Rhino Pismo Gloss Black/ Milled Spokes	9,5x17	3 920:-		9,5x18	4 252:-	
	9,5x18	4 496:-	9,5x20	4 560:-		
	9,5x20	5 020:-	Black Rhino Recon OD Green	9,5x17	3 908:-	
	12x20	5 284:-		9,5x18	4 252:-	
12x22	6 436:-	Black Rhino Recon Bronze	9,5x20	4 560:-		
Black Rhino Pondora Chrome	8,5x20		6 280:-	Black Rhino Reno Candy Red/ Black Lip Edge and Black Bolts	9x17	4 636:-
	9,5x22	7 276:-	9,5x18		5 112:-	
	10x24	8 328:-	9,5x20	5 780:-		
Black Rhino Pondora Gloss Black/Machine Cut Lip	8,5x20	4 708:-	Black Rhino RenoMatte Black/ Brass Bolts	9x17	4 108:-	
	9,5x22	5 808:-		9,5x18	4 636:-	
	10x24	6 964:-		9,5x20	5 208:-	
Black Rhino Pondora Silver/ Machine Cut Face and Lip	8,5x20	4 708:-	Black Rhino Reno Beadlock Candy Red/Black Ring and Black Bolts	8,5x17	6 640:-	
	9,5x22	5 808:-		Black Rhino Reno Beadlock Silver/ Mirror Face and Silver Bolts	8,5x17	6 732:-
	10x24	6 964:-				
Black Rhino PrimmCandy Red/ Black Bolts	9x17	4 088:-				
	9,5x18	4 568:-				
	9,5x20	5 016:-				
Black Rhino Primm Silver/	9x17	4 396:-				
	9,5x18	4 696:-				
	9,5x20	5 208:-				
Black Rhino Primm Matte Black/Brass Bolts	9x17	4 108:-				
	9,5x18	4 588:-				
	9,5x20	5 064:-				

Modell	Dim.	Pris brutto exkl. moms	Modell	Dim.	Pris brutto exkl. moms
Black Rhino Reno Beadlock Matte Black/Black Bolt	8,5x17	6 544:-		8,5x17 8x18 8,5x18	4 348:- 4 492:- 4 588:-
Black Rhino Ridge Matte Black	8,5x17 9x18	3 680:- 3 920:-	Black Rhino Sandstorm Candy Red (5+2)	7x15	3 536:-
Black Rhino Rift Beadlock Candy Red/Black Ring and Black Bolts	8,5x17	7 116:-	Black Rhino Sandstorm Candy Red (6+1)	7x15	3 536:-
Black Rhino Rift Beadlock Silver/Mirror Face and Stainless Bolts	8,5x17	7 256:-	Black Rhino Sandstorm Candy Red	7x15 8x17	3 536:- 4 252:-
Black Rhino Rift Beadlock Matte Gold/Machined Ring	8,5x17	7 212:-	Black Rhino Selkirk Gloss Black Milled	9x17 9x18 9x20 10x20	3 920:- 4 496:- 5 076:- 5 284:-
Black Rhino Rift Beadlock Matte Black/Black Bolts	8,5x17	6 972:-	Black Rhino Sentinel Desert Sand/Black Lip Edge	8,5x17 9,5x20	4 396:- 5 588:-
Black Rhino RiotMatte Black/Black Bolts	9x17	4 540:-	Black Rhino Sentinel Matte Black	8,5x17 9,5x20	4 108:- 5 256:-
Black Rhino Riot Candy Red/Black Lip and Black Bolts	9x17	4 920:-	Black Rhino Sentinel Cobalt Blue/Black Lip Edge	8,5x17 9,5x20	4 396:- 5 588:-
Black Rhino Riot Matte Bronze/Black Lip and Black Bolts	9x17	4 728:-	Black Rhino ShockwaveGloss Black/Milled Spoke	9,5x20 12x20	5 352:- 5 540:-
Black Rhino Riot Beadlock Matte Black/Black Ring and Black Bolts	8,5x17	6 924:-	Black Rhino Shrapnel Gloss Black/Milled Spokes	9,5x17 9,5x18 9,5x20	4 128:- 4 708:- 5 284:-
Black Rhino Riot Beadlock Matte Bronze/Black Ring and Black Bolts	8,5x17	7 020:-	Black Rhino Shredder Matte Black/Machined Dark Tint	9x17 9,5x18 9,5x20	4 340:- 4 836:- 5 436:-
Black Rhino Roku Gunblack	9,5x17 9,5x18 9,5x20	3 816:- 4 340:- 4 916:-	Black Rhino ShredderMatte Gunmetal/Black Lip Edge	9x17 9,5x18 9,5x20	4 340:- 4 836:- 5 436:-
Black Rhino Roku Matte Bronze	9,5x17 9,5x18 9,5x20	3 816:- 4 340:- 4 916:-	Black Rhino Sidewinder Matte Black	9x17 9x18 9x20	3 552:- 4 128:- 4 708:-
Black Rhino Rotorua Gloss Black	9,5x17 9,5x18 9,5x20	3 816:- 4 340:- 4 916:-	Black Rhino Sierra Gloss Black/Milled Spokes	9x17 9x18 9x20 10x20 11,5x20 10x22 11,5x22	3 816:- 4 340:- 4 864:- 5 076:- 5 732:- 6 544:- 6 732:-
Black Rhino Rumble Gloss Gold	7x15 7x16 8x17	3 448:- 3 656:- 3 868:-	Black Rhino SpearSilver/Mirror Cut Lip Edge	9x20 9,5x22 10x24	5 076:- 6 072:- 7 224:-
Black Rhino Rumble Gunblack	7x15 7x16 8x17 8,5x17	3 448:- 3 656:- 3 868:- 3 868:-	Black Rhino SpearMatte Black/Matte Machine Lip Edge	9x20 9,5x22 10x24	5 076:- 6 072:- 7 224:-
Black Rhino Rumble Olive Drab Green	7x15 7x16	3 448:- 3 656:-	Black Rhino Spear Matte Black	9x20 9,5x22 10x24	5 076:- 6 072:- 7 224:-
Black Rhino Rumble Bronze	7x15 7x16 8x17 8,5x17	3 448:- 3 656:- 3 868:- 3 868:-	Black Rhino SprocketMatte Gunmetal/Black Lip Edge (Gunmetal Bolts)	9,5x17 9,5x18 9,5x20	3 920:- 4 496:- 5 076:-
Black Rhino Sandstorm Semi Gloss Black/Machined Tint Ring (5+2)	7x15	3 536:-	Black Rhino Stadium Matte Black	8x16 8x17 8,5x17 9x17 9,5x17 8,5x18	3 444:- 3 632:- 3 632:- 3 728:- 3 972:- 4 024:-
Black Rhino Sandstorm Semi Gloss Black/Machined Tint Ring (6+1)	7x15	3 536:-			
Black Rhino Sandstorm Semi Gloss Black/Machined Dark Tint Ring	7x15 8x17	3 536:- 4 252:-			

Modell	Dim.	Pris brutto exkl. moms	Modell	Dim.	Pris brutto exkl. moms
	9x18	4 108:-		8x17	3 868:-
	9,5x18	4 348:-		9x17	3 972:-
	8X19	4 540:-		8x18	4 444:-
	8,5x20	4 728:-		9x18	4 548:-
	9x20	4 828:-		9x20	5 020:-
	9,5x20	5 064:-		10x22	6 492:-
Black Rhino Stadium Bronze	8x16	3 396:-	Black Rhino Waza Brushed Gunmetal	9x20	6 332:-
	8,5x17	3 632:-		9x22	6 972:-
	9,5x17	3 972:-		10x22	6 972:-
	9,5x18	4 348:-		10,5x22	6 972:-
Black Rhino Stadium Matte Bronze	8X19	4 540:-	Black Rhino Waza Matte Black	9x20	5 704:-
Black Rhino Tembe Gloss Black	9x20	5 076:-		9x22	6 684:-
	9,5x22	6 072:-		10x22	6 684:-
	10x24	6 964:-		10,5x22	6 684:-
Black Rhino Trabuco Matte Gunmetal/Black Lip Edge and Silver Bolts	8x17	4 128:-	Black Rhino Yellowstone Matte Gunmetal	8x16	3 488:-
	8x18	4 708:-		8x17	3 728:-
	10x20	4 920:-		8x18	4 076:-
	10x22	5 972:-	Black Rhino Yellowstone Matte Bronze	8x16	3 488:-
Black Rhino Trabuco Matte Black/ Black Bolts	8x17	4 128:-		8x17	3 728:-
	8x18	4 708:-		8x18	4 076:-
	10x20	4 920:-	Black Rhino Yellowstone Desert Sand	8x16	3 488:-
	10x22	5 972:-		8x17	3 728:-
Black Rhino Traverse Matte Black	9x20	4 708:-		8x18	4 076:-
	9,5x22	5 860:-	Black Rhino York Matte Gunmetal	7x14	2 536:-
	10x24	6 964:-		7x15	2 728:-
Black Rhino Traverse Silver/ Mirror Cut Face	9x20	4 708:-		8x17	3 708:-
	9,5x22	5 860:-		9x17	3 816:-
	10x24	6 964:-		8x18	4 340:-
Black Rhino Twister Gloss Black/ Milled Spokes Left	14x22	8 736:-		9x18	4 444:-
	14x24	9 120:-		9x20	4 916:-
Black Rhino Twister Gloss Black/ Milled Spokes Right	14x22	8 736:-	Black Rhino York Matte Black	8x17	3 708:-
	14x24	9 120:-		7x14	2 536:-
Black Rhino Twister Polished Left	14x22	8 928:-		7x15	2 728:-
	14x24	9 404:-		9x17	3 816:-
Black Rhino Twister Polished Right	14x22	8 928:-		8x18	4 340:-
	14x24	9 404:-	Black Rhino York Matte Black	9x20	4 916:-
Black Rhino Typhoon Gloss Black/ Milled Spoke	9,5x17	4 108:-	Black Rhino York UTV Matte Gunmetal	7x14	2 536:-
	9,5x18	4 444:-	Black Rhino Zion Gloss Black	8,5x18	4 340:-
	9,5x20	5 112:-		9x20	5 020:-
Black Rhino Unit Matte Black	7x15	3 012:-		9,5x22	6 072:-
	8x17	3 536:-	Coventry Ashford Gloss Black/ Mirror Cut Face	8,5x18	5 440:-
Black Rhino Unit Dark Bronze	7x15	3 060:-		8,5x19	6 016:-
	8x17	3 584:-		9,5x19	6 016:-
Black Rhino Wanaka Matte Black	8,5x17	3 680:-		9x20	6 544:-
	9x18	3 972:-		10,5x20	6 544:-
	9x20	4 636:-	Coventry Ashford High Gloss Gunmetal/Gloss Black Face	8,5x18	5 440:-
Black Rhino Wanaka Matte Gunmetal/Brushed Face and Gunmetal Tint	8,5x17	4 076:-		8,5x19	6 016:-
	9x18	4 348:-		9,5x19	6 016:-
	9x20	5 064:-		9x20	6 544:-
Black Rhino Warlord Matte Gunmetal	7x14	2 536:-		10,5x20	6 544:-
	7x15	2 728:-	Coventry Ashford Silver/Mirror Cut Face	8,5x18	5 440:-
	8x17	3 764:-		8,5x19	6 016:-
	9x17	3 868:-		9,5x19	6 016:-
	8x18	4 340:-		9x20	6 544:-
	9x18	4 444:-		10,5x20	6 544:-
	9x20	4 916:-	Coventry Whitley Chrome	8x17	5 284:-
	10x22	6 388:-		8,5x18	6 648:-
Black Rhino Warlord Matte Black/ Machined Dark Tint Lip	7x14	2 536:-		9,5x18	6 648:-
	7x15	2 728:-		8,5x19	7 276:-
				9,5x19	7 276:-
				8,5x20	8 116:-
				10x20	8 116:-

Modell	Dim.	Pris brutto exkl. moms	Modell	Dim.	Pris brutto exkl. moms
Coventry Whitley Gloss Black/ Mirror Cut Lip	8x17	4 024:-	Cray Falcon Matte Black	9X19	10 840:-
	8,5x18	4 548:-		9,5X19	10 840:-
	9,5x18	4 548:-		10x19	10 840:-
	8,5X19	5 232:-		10x20	12 270:-
	9,5X19	5 232:-		10,5x20	12 270:-
	8,5x20	5 808:-		11x20	12 270:-
	10x20	5 808:-	12,5x20	12 270:-	
Coventry WhitleyHyper Silver/ Mirror Cut Lip	8x17	4 024:-	Cray Falcon Full Polish	9X19	11 800:-
	8,5x18	4 548:-		9,5X19	11 800:-
	9,5x18	4 548:-		10x19	11 800:-
	8,5X19	5 232:-		10x20	13 220:-
	9,5X19	5 232:-		10,5x20	13 220:-
	8,5x20	5 808:-		11x20	13 220:-
	10x20	5 808:-	12,5x20	13 220:-	
Cray Astoria Gloss Black/ Mirror Cut Face	9x18	6 804:-	Cray Isurus Brushed Gunmetal	9X19	11 800:-
	9,5x18	6 804:-		9,5X19	11 800:-
	10x18	6 804:-		10x19	11 800:-
	9X19	7 384:-		10x20	13 220:-
	9,5X19	7 384:-		10,5x20	13 220:-
	10x19	7 384:-		11x20	13 220:-
	10,5x19	7 384:-	12,5x20	13 220:-	
	11x19	7 384:-	Cray Isurus Matte Black	9X19	10 840:-
	12x19	7 384:-		9,5X19	10 840:-
	10,5x20	7 908:-		10x19	10 840:-
	11x20	7 908:-		10x20	12 270:-
	12x20	7 908:-		10,5x20	12 270:-
		11x20		12 270:-	
			12,5x20	12 270:-	
Cray Astoria Matte Black	9x18	6 804:-	Cray Mako Gloss Black	9x18	6 804:-
	9,5x18	6 804:-		9,5x18	6 804:-
	10x18	6 804:-		9X19	7 384:-
	9X19	7 384:-		9,5X19	7 384:-
	9,5X19	7 384:-		10x19	7 384:-
	10x19	7 384:-		10,5x19	7 384:-
	10,5x19	7 384:-		11x19	7 384:-
	11x19	7 384:-		10,5x20	7 908:-
	12x19	7 384:-		11x20	7 908:-
	10,5x20	7 908:-		12x20	7 908:-
	11x20	7 908:-			
	12x20	7 908:-			
Cray Astoria High Gloss Gunmetal	9x18	6 804:-	Cray MakoSilver/Mirror Cut Face	9x18	6 804:-
	9,5x18	6 804:-		9,5x18	6 804:-
	10x18	6 804:-		9X19	7 384:-
	9X19	7 384:-		9,5X19	7 384:-
	9,5X19	7 384:-		10x19	7 384:-
	10x19	7 384:-		10,5x19	7 384:-
	10,5x19	7 384:-		11x19	7 384:-
	11x19	7 384:-		10,5x20	7 908:-
	12x19	7 384:-		11x20	7 908:-
	10,5x20	7 908:-		12x20	7 908:-
	11x20	7 908:-			
	12x20	7 908:-			
Cray Eagle Gloss Black/ Mirror Cut Lip	9x18	5 232:-	Cray Manta Chrome	9x17	6 804:-
	9X19	5 808:-		9x18	7 328:-
	10,5x19	5 808:-		10,5x18	7 328:-
	10,5x19	5 808:-		9X19	7 908:-
	10,5x20	6 332:-		10,5x19	7 908:-
	12,5x20	6 332:-		10,5x20	8 432:-
Cray Eagle Silver/ Mirror Cut Face and Lip	9x18	5 232:-	Cray Manta Gloss Black/ Mirror Cut Lip	9x17	4 708:-
	9X19	5 808:-		9x18	5 232:-
	10,5x19	5 808:-		10,5x18	5 232:-
	10,5x19	5 808:-		9X19	5 808:-
	10,5x20	6 332:-		10,5x19	5 808:-
	12,5x20	6 332:-		10,5x20	6 332:-
Cray EagleMatte Black	9x18	5 232:-	Cray Manta Hyper Silver/ Mirror Cut Lip	9x17	4 708:-
	9X19	5 808:-		9x18	5 232:-
	10,5x19	5 808:-		10,5x18	5 232:-
	10,5x20	6 332:-		9X19	5 808:-
	10,5x20	6 332:-		10,5x19	5 808:-
	12,5x20	6 332:-		9x20	6 332:-
			10,5x20	6 332:-	

Modell	Dim.	Pris brutto exkl. moms	Modell	Dim.	Pris brutto exkl. moms	
Cray Scorpion Chrome	9x17	6 804:-	Genius Darwin Matte Black	6,5x17	3 868:-	
	9x18	7 328:-		7,5x17	3 868:-	
	10,5x18	7 328:-		5,5x15	3 344:-	
	9X19	7 908:-			6,5x15	3 344:-
	10,5x19	7 908:-			6,5x17	3 868:-
	10,5x20	8 432:-			7,5x17	3 868:-
Cray ScorpionGloss Black/ Mirror Cut Lip	9x17	4 708:-	Genius Newton Hyper Silver	5,5x15	3 344:-	
	9x18	5 232:-		6,5x15	3 344:-	
	10,5x18	5 232:-		6,5x17	3 868:-	
	9X19	5 808:-		7,5x17	3 868:-	
	10,5x19	5 808:-	Genius Newton Matte Black	5,5x15	3 344:-	
	10,5x20	6 332:-		6,5x15	3 344:-	
Cray ScorpionHyper Silver/ Mirror Cut Lip	9x17	4 708:-		6,5x17	3 868:-	
	9x18	5 232:-	7,5x17	3 868:-		
	10,5x18	5 232:-	Mandrus 23 Gunmetal/ Mirror Cut Face	8x17	4 024:-	
	9X19	5 808:-		8,5x18	4 548:-	
	10,5x19	5 808:-		9,5x18	4 548:-	
	9x20	6 332:-		8,5X19	5 232:-	
10,5x20	6 332:-	9,5X19		5 232:-		
Cray Spider Gloss Black/ Mirror Cut Face	9x18	6 804:-		9x20	5 808:-	
	9,5x18	6 804:-	10x20	5 808:-		
	9X19	7 384:-	9x22	7 384:-		
	9,5X19	7 384:-	10,5x22	7 384:-		
	10x19	7 384:-	Mandrus 23 Matte Black	8x17	4 024:-	
	10,5x19	7 384:-		8,5x18	4 548:-	
	11x19	7 384:-		9,5x18	4 548:-	
	9,5x20	7 908:-		8,5X19	5 232:-	
	10,5x20	7 908:-		9,5X19	5 232:-	
	11x20	7 908:-		9x20	5 808:-	
	Cray Spider Silver/Mirror Cut Face	9x18	6 804:-	10x20	5 808:-	
		9,5x18	6 804:-	9x22	7 384:-	
9X19		7 384:-	10,5x22	7 384:-		
9,5X19		7 384:-	Mandrus Argent Gloss Gunmetal/ Mirror Cut Face	8x17	4 156:-	
10x19		7 384:-		8,5x18	4 728:-	
10,5x19		7 384:-		9,5x18	4 728:-	
11x19		7 384:-		8,5X19	5 352:-	
9,5x20		7 908:-		9,5X19	5 352:-	
10,5x20		7 908:-		8,5x20	5 732:-	
Cray Spider Matte Black		9x18	6 804:-	10x20	5 732:-	
		9,5x18	6 804:-	9x22	7 020:-	
		9X19	7 384:-	10,5x22	7 020:-	
	9,5X19	7 384:-	Mandrus Argent Matte Black	8x17	3 776:-	
	10x19	7 384:-		8,5x18	4 252:-	
	10,5x19	7 384:-		9,5x18	4 252:-	
	11x19	7 384:-		8,5X19	4 828:-	
	9,5x20	7 908:-		9,5X19	4 828:-	
	10,5x20	7 908:-		8,5x20	5 208:-	
	Cray Venom Brushed Gunmetal	9X19	11 800:-	10x20	5 208:-	
		9,5X19	11 800:-	9x22	6 304:-	
		10x19	11 800:-	10,5x22	6 304:-	
10x20		13 220:-	Mandrus Arrow Chrome	8x17	5 912:-	
10,5x20		13 220:-		9x17	5 912:-	
11x20		13 220:-		8,5x18	7 276:-	
12,5x20		13 220:-		9,5x18	7 276:-	
Cray Venom Matte Black		9X19		10 840:-	8,5X19	7 908:-
	9,5X19	10 840:-		9,5X19	7 908:-	
	10x19	10 840:-	8,5x20	8 748:-		
	10x20	12 270:-	10x20	8 748:-		
	10,5x20	12 270:-	Mandrus Arrow Gunmetal/ Mirror Cut Face	8x17	4 760:-	
	11x20	12 270:-		9x17	4 760:-	
12,5x20	12 270:-	8,5x18		5 284:-		
Genius Darwin Gunmetal/ Mirror Cut Lip	5,5x15	3 344:-		9,5x18	5 284:-	
	6,5x15	3 344:-		8,5X19	5 808:-	
				9,5X19	5 808:-	
			8,5x20	6 332:-		
			10x20	6 332:-		

Modell	Dim.	Pris brutto exkl. moms	Modell	Dim.	Pris brutto exkl. moms	
Mandrus Arrow Matte Black	8x17	4 760:-	Mandrus Klass Gloss Black	8x17	3 196:-	
	9x17	4 760:-		8,5x18	3 672:-	
	8,5x18	5 284:-		9,5x18	3 672:-	
	9,5x18	5 284:-		8,5X19	4 144:-	
	8,5X19	5 808:-		9,5X19	4 144:-	
	9,5X19	5 808:-		8,5x20	4 456:-	
	8,5x20	6 332:-		10x20	4 456:-	
	10x20	6 332:-		9x22	5 400:-	
Mandrus ATLAS Gunmetal/ Mirror Cut Face	7x16	3 764:-		10,5x22	5 400:-	
	7,5x17	4 024:-		Mandrus Klass Gloss Gunmetal/ Machined Tinted Face	8x17	3 276:-
	8x17	4 024:-			8,5x18	3 788:-
	8x18	4 548:-	9,5x18		3 788:-	
	8,5x18	4 548:-	8,5X19		4 300:-	
	9,5x18	4 548:-	9,5X19		4 300:-	
	8,5X19	5 232:-	8,5x20		4 616:-	
	9,5X19	5 232:-	10x20		4 616:-	
	9x20	5 808:-	9x22		5 636:-	
	10x20	5 808:-	10,5x22		5 636:-	
10x22	7 384:-	Mandrus Mannheim Chrome	8x17		5 232:-	
Mandrus Atlas Matte Black	8x18		4 548:-	8,5x18	6 596:-	
	7x16		3 764:-	9,5x18	6 596:-	
	7,5x17		4 024:-	8,5X19	7 276:-	
	8x17		4 024:-	9,5X19	7 276:-	
	8,5x18		4 548:-	8,5x20	8 064:-	
	9,5x18		4 548:-	9x20	8 064:-	
	8,5X19		5 232:-	10x20	8 064:-	
	9,5X19		5 232:-	9x22	9 744:-	
	9x20		5 808:-	10,5x22	9 744:-	
	10x20	5 808:-	Mandrus Mannheim Gunmetal/ Mirror Cut Face and Lip	8x17	4 024:-	
10x22	7 384:-	8,5x18		4 548:-		
Mandrus BremenSemi Gloss Black/Mirror Cut Face and Translucent Clear	8x17	3 276:-		9,5x18	4 548:-	
	8,5x18	3 788:-		8,5X19	5 232:-	
	9,5x18	3 788:-		9,5X19	5 232:-	
	8,5X19	4 300:-		9,5X19	5 232:-	
	9,5X19	4 300:-		8,5x20	5 808:-	
	8,5x20	4 616:-		9x20	5 808:-	
	10x20	4 616:-		10x20	5 808:-	
	9x22	5 636:-		9x22	7 384:-	
	10,5x22	5 636:-	10,5x22	7 384:-		
	Mandrus Bremen Gloss Gunmetal/Mirror Cut Face	8x17	3 436:-	Mandrus MascheSemi Gloss Black/Mirror Cut Face and Translucent Clear	8x17	3 324:-
8,5x18		3 868:-	8,5x18		3 756:-	
9,5x18		3 868:-	9,5x18		3 756:-	
8,5X19		4 420:-	8,5X19		4 320:-	
9,5X19		4 420:-	9,5X19		4 320:-	
8,5x20		4 732:-	9x20		4 796:-	
10x20		4 732:-	10x20		4 796:-	
9x22		5 796:-	9x22		6 100:-	
10,5x22		5 796:-	10,5x22		6 100:-	
Mandrus EstrellaGunmetal/ Mirror Cut Face and Lip Edge		8x17	4 024:-		Mandrus Masche Gloss Gunmetal/Mirror Cut Face	8x17
	8,5x18	4 548:-	8,5x18	3 756:-		
	9,5x18	4 548:-	9,5x18	3 756:-		
	8,5X19	5 232 k	8,5X19	4 320:-		
	9,5X19	5 232:-	9,5X19	4 320:-		
	9x20	5 808:-	9x20	4 796:-		
	10x20	5 808:-	10x20	4 796:-		
Mandrus Estrella Matte Black/ Machine Lip Edge	8x17	4 024:-	Mandrus Miglia Semi Gloss Black	8,5X19	5 732:-	
	8,5x18	4 548:-		9,5X19	5 732:-	
	9,5x18	4 548:-		9x20	6 592:-	
	8,5X19	5 232:-		10x20	6 592:-	
	9,5X19	5 232:-		9x22	7 736:-	
	10x20	5 808:-		10x22	7 736:-	
Mandrus FORSCHER Matte Gunmetal/Black Lip Edge	8x16	4 728:-	Mandrus Miglia Gloss Gunmetal	8,5X19	5 732:-	
	8x17	4 920:-		9,5X19	5 732:-	
	9x20	6 160:-		9x20	6 592:-	
Mandrus FORSCHER Matte Black	8x16	4 444:-				
	8x17	4 588:-				
	9x20	5 732:-				

Modell	Dim.	Pris brutto exkl. moms	Modell	Dim.	Pris brutto exkl. moms
	10x20	6 592:-		9,5x18	5 284:-
	9x22	7 736:-		8,5x19	5 808:-
	10x22	7 736:-		9,5x19	5 808:-
	10,5x22	7 736:-		8,5x20	6 332:-
	11x22	7 736:-		10x20	6 332:-
				11x20	6 332:-
Mandrus Millenium Chrome	8x17	5 232:-		9x22	8 380:-
	8,5x18	6 596:-		10x22	8 380:-
	9,5x18	6 596:-		10,5x22	8 380:-
	8,5x19	7 276:-	Mandrus Stark Gunmetal/ Mirror Cut Face and Lip	7x16	3 764:-
	9,5x19	7 276:-		7,5x17	4 024:-
	8,5x20	8 064:-		8x18	4 548:-
	9x20	8 064:-			
	10x20	8 064:-	Mandrus Stark Matte Black/ Machine Lip Edge	7x16	3 764:-
	9x22	9 744:-		7,5x17	4 024:-
	10,5x22	9 744:-		8x18	4 548:-
Mandrus MilleniumGloss Black/ Mirror Cut Lip	8x17	4 024:-	Mandrus Stirling Gloss Gunmetal	8x17	4 760:-
	8,5x18	4 548:-		8,5x18	5 284:-
	9,5x18	4 548:-		9,5x18	5 284:-
	8,5x19	5 232:-		8,5x19	5 808:-
	9,5x19	5 232:-		9,5x19	5 808:-
	8,5x20	5 808:-		9x20	6 332:-
	9x20	5 808:-		10x20	6 332:-
	10x20	5 808:-		9x22	8 380:-
	9x22	7 384:-		10x22	8 380:-
	10,5x22	7 384:-		10,5x22	8 380:-
				11,5x22	8 380:-
Mandrus Millenium Hyper Silver/ Mirror Cut Lip	8x17	4 024:-	Mandrus Stirling Silver/Mirror Cut Face	8x17	4 760:-
	8,5x18	4 548:-		8,5x18	5 284:-
	9,5x18	4 548:-		9,5x18	5 284:-
	8,5x19	5 232:-		8,5x19	5 808:-
	9,5x19	5 232:-		9,5x19	5 808:-
	8,5x20	5 808:-		9x20	6 332:-
	9x20	5 808:-		10x20	6 332:-
	10x20	5 808:-		9x22	8 380:-
	9x22	7 384:-		10x22	8 380:-
	10,5x22	7 384:-		10,5x22	8 380:-
				11,5x22	8 380:-
Mandrus Otto Gloss Black	8x17	4 024:-	Mandrus Wilhelm Gloss Black/ Mirror Cut Lip	8x17	4 024:-
	8,5x18	4 548:-		8,5x18	4 548:-
	9,5x18	4 548:-		9,5x18	4 548:-
	8,5x19	5 232:-		8,5x19	5 232:-
	9,5x19	5 232:-		9,5x19	5 232:-
	9x20	5 808:-		9,5x19	5 232:-
	10x20	5 808:-		8,5x20	5 808:-
	9x22	7 384:-		10x20	5 808:-
	10x22	7 384:-		11x20	5 808:-
	10,5x22	7 384:-		9x22	7 384:-
				10,5x22	7 384:-
Mandrus Otto Gunmetal/ Mirror Cut Face	8x17	4 024:-	Mandrus Wilhelm Chrome	8x17	5 232:-
	8,5x18	4 548:-		8,5x18	6 596:-
	9,5x18	4 548:-		9,5x18	6 596:-
	8,5x19	5 232:-		8,5x19	7 276:-
	9,5x19	5 232:-		9,5x19	7 276:-
	9x20	5 808:-		8,5x20	8 064:-
	10x20	5 808:-		9x20	8 064:-
	9x22	7 384:-		10x20	8 064:-
	10x22	7 384:-		11x20	8 064:-
	10,5x22	7 384:-		9x22	9 744:-
				10,5x22	9 744:-
Mandrus Rotec Matte Black	8x17	4 760:-	Mandrus Wilhelm Silver/ Mirror Cut Face and Lip	8x17	4 024:-
	9x17	4 760:-		8,5x18	4 548:-
	8,5x18	5 284:-		8,5x18	4 548:-
	9,5x18	5 284:-		9,5x18	4 548:-
	8,5x19	5 808:-		8,5x19	5 232:-
	9,5x19	5 808:-		9,5x19	5 232:-
	8,5x20	6 332:-		8,5x20	5 808:-
	10x20	6 332:-		9x20	5 808:-
	9x22	8 380:-		10x20	5 808:-
	10x22	8 380:-			
	10,5x22	8 380:-			
Mandrus Rotec Silver/ Mirror Cut Face	8x17	4 760:-			
	9x17	4 760:-			
	8,5x18	5 284:-			

Modell	Dim.	Pris brutto exkl. moms	Modell	Dim.	Pris brutto exkl. moms
	9x22	7 384:-			
	10,5x22	7 384:-			
Mandrus Wolf Gloss Black	10,5x22	7 384:-	Petrol P3A Matte Black	8x17	3 184:-
	10x24	8 956:-		8x18	3 500:-
				8X19	3 764:-
Mandrus WolfGloss Gunmetal/ Mirror Cut Face	10,5x22	7 384:-	Petrol P3B Gloss Silver	6,5x15	2 764:-
	10x24	8 956:-		7x16	2 924:-
				7x17	3 080:-
Petrol P0A Gloss Black/ Machine Cut Face	8x17	3 184:-	Petrol P3B Matte Black	6,5x15	2 764:-
	8x18	3 500:-		7x16	2 924:-
	8X19	3 764:-		7x17	3 080:-
Petrol P0A Matte Black	8x17	3 184:-	Petrol P3C Gloss Black/ Machined Face	8x17	3 156:-
	8x18	3 500:-		8x18	3 488:-
	8X19	3 764:-		8X19	3 824:-
				8,5x20	4 208:-
Petrol P1AGloss Black/ Machine Cut Face	8x17	3 184:-	Petrol P3C Semi Gloss Black	8x17	3 060:-
	8x18	3 500:-		8x18	3 444:-
	8X19	3 764:-		8X19	3 728:-
				8,5x20	6 828:-
Petrol P1B Gloss Black/ Machine Cut Lip	8x17	3 184:-	Petrol P4B Gloss Black	8x17	3 184:-
	8x18	3 500:-		8x18	3 500:-
	8X19	3 764:-		8X19	3 764:-
	8,5x20	4 340:-		8,5x20	4 340:-
Petrol P1B Matte Black	8x17	3 184:-	Petrol P4B Matte Bronze	8x17	3 184:-
	8x18	3 500:-		8x18	3 500:-
	8X19	3 764:-		8X19	3 764:-
	8,5x20	4 340:-		8,5x20	4 340:-
Petrol P1C Gloss Black	8x17	3 060:-	Petrol P4C Gloss Black/ Machined Lip	7x16	2 964:-
	8x18	3 396:-		8x17	3 156:-
	8X19	3 728:-		8x18	3 488:-
	8,5x20	4 076:-		8X19	3 824:-
				8,5x20	4 208:-
Petrol P1C Gloss Black/ Machined Face	8x17	3 156:-	Petrol P4C Silver/ Machined Face and Lip	7x16	2 964:-
	8x18	3 488:-		8x17	3 156:-
	8X19	3 824:-		8x18	3 488:-
	8,5x20	4 208:-		8X19	3 824:-
				8,5x20	4 208:-
Petrol P2A Silver/Machine Cut Face	8x17	3 184:-	Petrol P5A Gloss Black/ Machine Cut Face	7,5x17	3 132:-
	8x18	3 500:-		8x18	3 500:-
	8X19	3 764:-		8X19	3 764:-
Petrol P2A Matte Black	8x17	3 184:-	Petrol P6A Matte Black	7,5x17	3 132:-
	8x18	3 500:-		8x18	3 500:-
	8X19	3 764:-		8X19	3 764:-
Petrol P2B Gloss Black	7x15	2 816:-	Redbourne Alston Gloss White	8,5x18	4 540:-
	7x16	2 924:-		8,5x20	5 496:-
	8x17	3 184:-	Redbourne Alston Matte Black/ Machined Dark Tint Lip	8,5x18	4 684:-
	8x18	3 500:-		8,5x20	5 780:-
	8X19	3 764:-	Redbourne Bashford Gunmetal/ Mirror Cut Face	10x22	7 020:-
	8,5x20	4 340:-			
Petrol P2B Gloss Black/ Machined Face	7x15	2 816:-	Redbourne Bashford Matte Gunmetal	9,5x20	6 332:-
	7x16	2 924:-			
	8x17	3 184:-	Redbourne Bashford Matte Gunmetal	10x22	7 020:-
	8x17	3 184:-			
	8x17	3 184:-	Redbourne Crown Gloss Black	10x22	6 972:-
	8x17	3 184:-		10x24	7 928:-
	8x18	3 500:-	Redbourne Crown Matte Black/ Machined Face/Ball Milled Spoke and Translucent Clear Tint	10x22	7 256:-
	8X19	3 764:-		10x24	8 212:-
	8,5x20	4 340:-	Redbourne Dominus Gloss Black/	9,5x20	6 332:-
Petrol P2C Semi Gloss Black	7x16	2 916:-			
	8x17	3 108:-			
	8x18	3 444:-			
	8X19	3 728:-			
	8,5x20	4 076:-			
Petrol P3A Silver/Machine Cut Face	8x17	3 184:-			
	8x18	3 500:-			
	8X19	3 764:-			

Modell	Dim.	Pris brutto exkl. moms	Modell	Dim.	Pris brutto exkl. moms
Mirror Cut Face	9,5x22	8 064:-	Matte Machined Face	10x22	7 020:-
Redbourne Dominus Gunmetal/ Mirror Cut Face	9,5x20 9,5x22	6 332:- 8 064:-	Redbourne Noble Matte Gunmetal	9,5x20 10x22	6 332:- 7 020:-
Redbourne Dominus Matte Black	9,5x20 9,5x22	6 332:- 8 064:-	Redbourne Royalty Carbon Graphite	10,5x22 10x24	6 732:- 8 212:-
Redbourne Dominus Silver/ Mirror Cut Face	9,5x20 9,5x22	6 332:- 8 064:-	Redbourne Royalty Gloss Black	10,5x22 10x24	6 352:- 7 784:-
Redbourne Hercules Gloss Gunmetal	9,5x20 10x22	6 332:- 7 020:-	Redbourne Royalty Rose Gold	10,5x22 10x24	6 732:- 8 212:-
Redbourne Hercules Silver/ Mirror Cut Face	9,5x20 10x22	6 332:- 7 020:-	Redbourne Vincent Gloss Black	10,5x22 10x24	6 160:- 7 592:-
Redbourne Hercules Matte Black	9,5x20 10x22	6 332:- 7 020:-	Redbourne Vincent Gloss Black/ Mirror Cut Face	10,5x22 10x24	6 544:- 7 976:-
Redbourne Kensington Gloss Black	10x22 10x24	8 064:- 9 692:-	Redbourne Vincent Gloss Gunmetal	10,5x22 10x24	6 160:- 7 592:-
Redbourne Kensington Gloss Gunmetal	10x22 10x24	8 064:- 9 692:-	Redbourne Westminster Gloss Black	10x22	7 020:-
Redbourne King Gloss Gunmetal	9,5x20 10x22	6 332:- 7 020:-	Redbourne Westminster Matte Black/Machined Face and Dark Matte Tint	10x22	7 020:-
Redbourne King Matte Black	9,5x20 10x22	6 332:- 7 020:-	TSW Aileron Metallic Gunmetal	8,5x20 10x20 10,5x20 9x21 10,5x21 11x21 9x22 10,5x22 11x22	5 596:- 5 596:- 5 596:- 6 228:- 6 228:- 6 228:- 6 700:- 6 700:- 6 700:-
Redbourne Manor Gloss Black	9,5x20 9,5x22	6 332:- 8 064:-	TSW Ascent Matte Gunmetal/ Gloss Black Face	8x17 8,5x18 9,5x18 8,5x19 9,5x19 8,5x20 10x20	3 920:- 4 444:- 4 444:- 5 020:- 5 020:- 5 596:- 5 596:-
Redbourne Manor Matte Black/ Matte Machined Face	9,5x20 9,5x22	6 332:- 8 064:-	TSW Ascent Matte Titanium Silver	8x17 8,5x18 9,5x18 8,5x19 9,5x19 8,5x20 10x20	3 920:- 4 444:- 4 444:- 5 020:- 5 020:- 5 596:- 5 596:-
Redbourne Manor Silver/ Mirror Cut Face	9,5x20 9,5x22	6 332:- 8 064:-	TSW Avalon Bronze/Brushed Bronze Face and Machined Lip	8,5x18 9,5x18 8,5x19 9x19 10x19 8,5x20 9x20 10x20	5 336:- 5 336:- 5 912:- 5 912:- 5 912:- 6 492:- 6 492:- 6 492:-
Redbourne Mayfair Gloss Black	10x22 10x24	6 544:- 7 976:-	TSW Avalon Gunmetal/Brushed Gunmetal Face and Machined Lip	8,5x18 9,5x18 8,5x19 8,5x19 9x19 9,5x19 10x19 11x19 8,5x20 9x20 10x20	5 336:- 5 336:- 5 912:- 5 912:- 5 912:- 5 912:- 5 912:- 5 912:- 6 492:- 6 492:- 6 492:-
Redbourne Mayfair Gloss Gunmetal	10x22 10x24	6 544:- 7 976:-			
Redbourne Mayfair Silver/ Mirror Cut Face	10x22 10x24	6 544:- 7 976:-			
Redbourne Meridian Gloss Black	9,5x20 10x22	6 332:- 7 020:-			
Redbourne Meridian Gloss Black/ Mirror Cut Face	9,5x20 10x22	6 332:- 7 020:-			
Redbourne Morland Gloss Metallic Black/Brushed Tinted Face and Black Bolts	8,5x18 8,5x20	5 256:- 6 448:-			
Redbourne Morland Matte Black	8,5x18 8,5x20	4 728:- 5 732:-			
Redbourne Noble Double Black - Matte Black/Gloss Black Face	9,5x20 10x22	6 332:- 7 020:-			
Redbourne Noble Gloss Gunmetal/Gloss Black Face	9,5x20 10x22	6 332:- 7 020:-			
Redbourne Noble Gloss Titanium/Gloss Black Face	9,5x20 10x22 9,5x20	6 332:- 7 020:- 6 332:-			
Redbourne Noble Matte Black	9,5x20 10x22	6 332:- 7 020:-			
Redbourne Noble Matte Black/	9,5x20	6 332:-			

Modell	Dim.	Pris brutto exkl. moms	Modell	Dim.	Pris brutto exkl. moms
TSW Bardo Hyper Silver	8x17	3 920:-	TSW Bristol Silver/Mirror Cut Face	8x17	3 920:-
	8x18	4 444:-		8,5x18	4 444:-
	9,5x18	4 444:-		9,5x18	4 444:-
	8X19	5 020:-		8,5X19	5 020:-
	9,5X19	5 020:-		9,5X19	5 020:-
	8,5x20	5 596:-		8,5x20	5 596:-
	10x20	5 596:-		10x20	5 596:-
				10,5x20	5 596:-
				10,5x22	6 700:-
TSW Bardo Matte Black	8x17	3 920:-	TSW Brooklands Matte Black	8x17	3 920:-
	8x18	4 444:-		8x18	4 444:-
	9,5x18	4 444:-		9,5x18	4 444:-
	8X19	5 020:-		8X19	5 020:-
	9,5X19	5 020:-		9,5X19	5 020:-
	8,5x20	5 596:-		8,5x20	5 596:-
	10x20	5 596:-		10x20	5 596:-
TSW Bathurst Gloss Gunmetal	8x17	4 760:-	TSW Brooklands Silver/ Mirror Cut Face	8x17	3 920:-
	9x17	4 760:-		8x18	4 444:-
	8x18	5 336:-		9,5x18	4 444:-
	8,5x18	5 336:-		8X19	5 020:-
	9x18	5 336:-		9,5X19	5 020:-
	9,5x18	5 336:-		8,5x20	5 596:-
	10,5x18	5 336:-		10x20	5 596:-
	8X19	5 912:-	TSW CadwellGunmetal Mirror Cut Face/Lip	8x17	3 920:-
	8,5X19	5 912:-		8x18	4 444:-
	9X19	5 912:-		9,5x18	4 444:-
	9,5X19	5 912:-		8X19	5 020:-
	10,5x19	5 912:-		9,5X19	5 020:-
	8,5x20	6 492:-		8,5x20	5 596:-
	9x20	6 492:-		10x20	5 596:-
	10x20	6 492:-	TSW Chappelle Matte Black	8x17	3 920:-
	10,5x20	6 492:-		8,5x18	4 444:-
9,5x20	6 492:-	9,5x18		4 444:-	
11x20	6 492:-	8,5X19		5 020:-	
9x21	7 172:-	9,5X19		5 020:-	
10x21	7 172:-	8,5x20		5 596:-	
10,5x21	7 172:-		10x20	5 596:-	
11x21	7 172:-	TSW Chicane Gloss Black/ Mirror Cut Face	8x17	3 920:-	
TSW Bathurst Silver/ Mirror Cut Face	9,5x20		6 492:-	8,5x18	4 444:-
	11x20		6 492:-	9,5x18	4 444:-
	9x21		7 172:-	8,5X19	5 020:-
	10x21		7 172:-	9,5X19	5 020:-
	10,5x21		7 172:-	8,5x20	5 596:-
	11x21	7 172:-		10x20	5 596:-
8x17	4 760:-	TSW Chicane Matte Gunmetal	8x17	3 920:-	
9x17	4 760:-		8,5x18	4 444:-	
8x18	5 336:-		9,5x18	4 444:-	
8,5x18	5 336:-		8,5X19	5 020:-	
9x18	5 336:-		9,5X19	5 020:-	
9,5x18	5 336:-		8,5x20	5 596:-	
10,5x18	5 336:-		10x20	5 596:-	
8X19	5 912:-	TSW Chrono Silver/Mirror Cut Face	8x17	4 760:-	
8,5X19	5 912:-		8,5x18	5 336:-	
9X19	5 912:-		9,5x18	5 336:-	
9,5X19	5 912:-		8,5X19	5 912:-	
10,5x19	5 912:-		9,5X19	5 912:-	
8,5x20	6 492:-		10x19	5 912:-	
9x20	6 492:-	8,5x20	6 492:-		
10x20	6 492:-	9x20	6 492:-		
10,5x20	6 492:-	10x20	6 492:-		
TSW Blanchimont Semi Gloss Black	8,5X19	5 540:-	9x21	7 172:-	
	9,5X19	5 540:-	10x21	7 172:-	
	9x20	6 448:-	11x21	7 172:-	
	10,5x20	6 448:-	TSW Chrono Matte Black/ Machined Face and Dark Tint	8x17	4 760:-
TSW Bristol Matte Black	8x17	3 920:-		8,5x18	5 336:-
	8,5x18	4 444:-		9,5x18	5 336:-
	9,5x18	4 444:-		8,5X19	5 912:-
	8,5X19	5 020:-		9,5X19	5 912:-
	9,5X19	5 020:-		10x19	5 912:-
	8,5x20	5 596:-	8,5x20	6 492:-	
10x20	5 596:-	9x20	6 492:-		
10,5x20	5 596:-	10x20	6 492:-		
10,5x22	6 700:-	9x21	7 172:-		

Modell	Dim.	Pris brutto exkl. moms	Modell	Dim.	Pris brutto exkl. moms
	10x19	5 912:-	TSW Evo-T Matte Black	8,5X19	4 636:-
	8,5x20	6 492:-		9,5X19	4 636:-
	9x20	6 492:-		9x20	5 112:-
	10x20	6 492:-		10,5x20	5 112:-
	9x21	7 172:-			
	10x21	7 172:-	TSW GATSBY Gunmetal/ Mirror Cut Face	8,5x20	5 596:-
	10,5x21	7 172:-		10x20	5 596:-
	11x21	7 172:-		9x22	6 700:-
TSW Clypse Gloss Black	8,5x18	4 444:-	TSW GATSBY Matte Black	10x20	5 596:-
	9,5x18	4 444:-		8,5x20	5 596:-
	8,5X19	5 020:-		9x22	6 700:-
	9,5X19	5 020:-		10x22	6 700:-
	8,5x20	5 596:-	TSW Gatsby Gunmetal/ Mirror Cut Face	10x20	5 596:-
	10x20	5 596:-		10x22	6 700:-
	10,5x20	5 596:-	TSW Gatsby Silver/Mirror Cut Face	8,5x20	5 596:-
	9x22	6 700:-		10x20	5 596:-
	10,5x22	6 700:-		9x22	6 700:-
	11x22	6 700:-		10x22	6 700:-
TSW Clypse Titanium/ Matte Brushed Face	8,5x18	4 656:-	TSW Geneva Matte Gunmetal	8x17	4 760:-
	9,5x18	4 656:-		8x18	5 336:-
	8,5X19	5 232:-		8,5x18	5 336:-
	9,5X19	5 232:-		9x18	5 336:-
	8,5x20	5 808:-		9,5x18	5 336:-
	10x20	5 808:-		10,5x18	5 336:-
	10,5x20	5 808:-		10,5x18	5 336:-
	9x22	6 964:-		8X19	5 912:-
	10,5x22	6 964:-		8,5X19	5 912:-
	11x22	6 964:-		9X19	5 912:-
TSW Crowthorne Matte Black	8x17	3 488:-		9,5X19	5 912:-
	8,5x18	3 972:-		10,5x19	5 912:-
	9,5x18	3 972:-		8,5x20	6 492:-
	8,5X19	4 444:-		9x20	6 492:-
	9,5X19	4 444:-		9,5x20	6 492:-
	9,5X19	4 444:-		10x20	6 492:-
	9,5X19	4 444:-		10,5x20	6 492:-
	8,5x20	4 920:-		11x20	6 492:-
	10x20	4 920:-	TSW Geneva Matte Titanium Silver	8x17	4 760:-
TSW Crowthorne Matte Gunmetal/ Matte Machined Face	8x17	3 488:-		8x18	5 336:-
	8,5x18	3 972:-		8,5x18	5 336:-
	9,5x18	3 972:-		9x18	5 336:-
	8,5X19	4 444:-		9,5x18	5 336:-
	9,5X19	4 444:-		10,5x18	5 336:-
	9,5X19	4 444:-		10,5x18	5 336:-
	9,5X19	4 444:-		8X19	5 912:-
	8,5x20	4 920:-		8,5X19	5 912:-
	10x20	4 920:-		9X19	5 912:-
TSW Donington Gunmetal/ Mirror Cut Face	7x17	3 488:-		9,5X19	5 912:-
	8x17	3 488:-		10,5x19	5 912:-
	8x18	3 972:-		8,5x20	6 492:-
	9,5x18	3 972:-		9x20	6 492:-
	8X19	4 444:-		9,5x20	6 492:-
	9,5X19	4 444:-		10x20	6 492:-
	8,5x20	4 920:-		10,5x20	6 492:-
	10x20	4 920:-		11x20	6 492:-
	9x22	5 304:-	TSW Hockenheim S Silver/ Mirror Cut Lip	8x17	3 920:-
	10,5x22	5 304:-		8,5x18	4 444:-
TSW Donington Matte Black	7x17	3 488:-		9,5x18	4 444:-
	8x17	3 488:-		8,5X19	5 020:-
	8x18	3 972:-		9,5X19	5 020:-
	9,5x18	3 972:-		9,5X19	5 020:-
	8X19	4 444:-		8,5x20	5 596:-
	9,5X19	4 444:-		10x20	5 596:-
	8,5x20	4 920:-	TSW Hockenheim-T Double Black/ Ball Milled Spoke	9,5X19	4 636:-
	10x20	4 920:-		9x20	5 112:-
	9x22	5 304:-		10,5x20	5 112:-
	10,5x22	5 304:-	TSW Hockenheim-T Silver/ Brushed Silver Face and Ball Milled Spoke	9,5X19	4 636:-
TSW Evo-T Silver/Brushed Face	8,5X19	4 636:-		9x20	5 112:-
	9,5X19	4 636:-		10,5x20	5 112:-
	9x20	5 112:-			
	10,5x20	5 112:-			

Modell	Dim.	Pris brutto exkl. moms	Modell	Dim.	Pris brutto exkl. moms
TSW Hockenheim-T Silver/ Brushed Silver Face and Ball Milled Spoke [R]	10,5x20	5 112:-	TSW Max Matte Black	8x17	3 920:-
TSW Jarama Chrome	8x17	5 124:-		9x17	3 920:-
	8x18	6 492:-		8,5x18	4 444:-
	9,5x18	6 492:-		9,5x18	4 444:-
	8X19	7 016:-		10x18	4 444:-
	9,5X19	7 016:-		8,5X19	5 020:-
	8,5x20	7 592:-		9X19	5 020:-
	10x20	7 592:-		9,5X19	5 020:-
TSW Jarama Gloss Black/	8x17	3 920:-		10,5x19	5 020:-
	8x18	4 444:-		8,5x20	5 596:-
	9,5x18	4 444:-		9x20	5 596:-
	8X19	5 020:-		10x20	5 596:-
	9,5X19	5 020:-	TSW Mechanica Silver/ Mirror Cut Face	8x17	4 760:-
	8,5x20	5 596:-		8x18	5 336:-
	10x20	5 596:-		8,5x18	5 336:-
TSW Jarama Hyper Silver/ Mirror Cut Lip	8x17	3 920:-		9x18	5 336:-
	8x18	4 444:-		9,5x18	5 336:-
	9,5x18	4 444:-		10,5x18	5 336:-
	8X19	5 020:-		8X19	5 912:-
	9,5X19	5 020:-		8,5X19	5 912:-
	8,5x20	5 596:-		9X19	5 912:-
	10x20	5 596:-		9,5X19	5 912:-
TSW Luco Gloss Black	8x17	3 920:-		10,5x19	5 912:-
	8,5x18	4 444:-		8,5x20	6 492:-
	9,5x18	4 444:-		9x20	6 492:-
	8,5X19	5 020:-		9,5x20	6 492:-
	9,5X19	5 020:-		10x20	6 492:-
	8,5x20	5 596:-		10,5x20	6 492:-
	10x20	5 596:-		11x20	6 492:-
TSW Luco Matte Black/ Machined Face and Dark Tint	8x17	3 920:-	TSW Mechanica Matte Gunmetal/ Matte Black Face	8x17	4 760:-
	8,5x18	4 444:-		8x18	5 336:-
	9,5x18	4 444:-		8,5x18	5 336:-
	8,5X19	5 020:-		9x18	5 336:-
	9,5X19	5 020:-		9,5x18	5 336:-
	8,5x20	5 596:-		10,5x18	5 336:-
	10x20	5 596:-		10,5x18	5 336:-
TSW Mallory Matte Black	7x17	3 920:-		8X19	5 912:-
	8x17	3 920:-		8,5X19	5 912:-
	8x18	4 444:-		9X19	5 912:-
	9,5x18	4 444:-		9,5X19	5 912:-
	8X19	5 020:-		10,5x19	6 492:-
	9,5X19	5 020:-		8,5x20	6 492:-
	8,5x20	5 596:-		9x20	6 492:-
	10x20	5 596:-		9,5x20	6 492:-
TSW Mallory Silver/Mirror Cut Face	7x17	3 920:-		10x20	6 492:-
	8x17	3 920:-		10,5x20	6 492:-
	8x18	4 444:-		11x20	6 492:-
	9,5x18	4 444:-	TSW Molteno Hyper Silver	8,5x18	3 662:-
	8X19	5 020:-		9,5x18	3 632:-
	9,5X19	5 020:-		8,5X19	4 144:-
	8,5x20	5 596:-		9,5X19	4 144:-
	10x20	5 596:-		8,5x20	4 456:-
TSW Max Hyper Silver	8x17	3 920:-		10x20	4 456:-
	9x17	3 920:-	TSW Molteno Matte Black	8,5x18	3 396:-
	8,5x18	4 444:-		9,5x18	3 396:-
	9,5x18	4 444:-		8,5X19	3 828:-
	10x18	4 444:-		9,5X19	3 828:-
	8,5X19	5 020:-		8,5x20	4 144:-
	9X19	5 020:-		10x20	4 144:-
	9,5X19	5 020:-	TSW Mosport Gloss Black	8,5x18	4 444:-
	10,5x19	5 020:-		9,5x18	4 444:-
	8,5x20	5 596:-		8,5X19	5 020:-
	9x20	5 596:-		9,5X19	5 020:-
	10x20	5 596:-		8,5x20	5 596:-
	10,5x20	5 596:-		10x20	5 596:-
				10,5x20	5 596:-
				9x22	6 700:-
				10,5x22	6 700:-
				11x22	6 700:-

Modell	Dim.	Pris brutto exkl. moms	Modell	Dim.	Pris brutto exkl. moms
TSW Mosport Matte Black/ Machined Face and Dark Tint	8,5x18	4 444:-		8x18	5 336:-
	9,5x18	4 444:-		8,5x18	5 336:-
	8,5X19	5 020:-		9x18	5 336:-
	9,5X19	5 020:-		9,5x18	5 336:-
	8,5x20	5 596:-		10,5x18	5 336:-
	10,5x20	5 596:-		9X19	5 912:-
	9x22	6 700:-		10,5x19	5 912:-
	10,5x22	6 700:-		8,5x20	6 492:-
	11x22	6 700:-		9x20	6 492:-
				9x20	6 492:-
TSW Neptune Battleship Gray	8x18	4 876:-		10x20	6 492:-
	8,5x18	4 876:-		10,5x20	6 492:-
	8,5X19	5 540:-		8x18	5 336:-
	9,5X19	5 540:-		8X19	5 912:-
TSW Neptune Bronze	8x18	4 876:-		8,5X19	5 912:-
	8,5x18	4 876:-		9,5X19	5 912:-
	9,5x18	4 876:-	TSW NurburgringMatte Gunmetal	8X19	5 912:-
	8X19	5 540:-		7,5x17	4 760:-
	8,5X19	5 540:-		8x17	4 760:-
	9,5X19	5 540:-		9x17	4 760:-
	8,5x20	6 352:-		7,5x18	5 336:-
	9x20	6 352:-		8x18	5 336:-
	10x20	6 352:-		8,5x18	5 336:-
				9x18	5 336:-
		9,5x18		5 336:-	
		10,5x18		5 336:-	
TSW Neptune Semi Gloss Black	8x18	4 876:-		9X19	5 912:-
	8,5x18	4 876:-		10,5x19	5 912:-
	9,5x18	4 876:-		8,5x20	6 492:-
	8X19	5 540:-		9x20	6 492:-
	8,5X19	5 540:-		10x20	6 492:-
	9,5X19	5 540:-		10,5x20	6 492:-
	8,5x20	6 352:-		9x21	7 172:-
	9x20	6 352:-		10x21	7 172:-
	10x20	6 352:-		10,5x21	7 172:-
TSW Nord Semi Gloss Black	8,5X19	5 780:-		11x21	7 172:-
	9,5X19	5 780:-		9x22	7 592:-
	9x20	6 544:-		10x22	7 592:-
	10,5x20	6 544:-		10,5x22	7 592:-
TSW Nord Semi Gloss Black/ Ball Milling and Machined Dark Tint Face	9,5X19	6 352:-		11x22	7 592:-
	9x20	7 212:-		8X19	5 912:-
	10,5x20	7 212:-		8,5X19	5 912:-
TSW Nurburgring Gunmetal/ Mirror Cut Face	7,5x17	4 760:-		9,5X19	5 912:-
	8x17	4 760:-	TSW Paddock Semi Gloss Black/ Machined Tinted Ring	8x17	4 540:-
	9x17	4 760:-		8,5x18	5 064:-
	7,5x18	5 336:-		9,5x18	5 064:-
	8x18	5 336:-		8,5X19	5 732:-
	8,5x18	5 336:-		9X19	5 732:-
	9x18	5 336:-		9,5X19	5 732:-
	9,5x18	5 336:-		8,5x20	6 544:-
	10,5x18	5 336:-		9x20	6 544:-
	8X19	5 912:-		10x20	6 544:-
	9X19	5 912:-			
	10,5x19	5 912:-	TSW Paddock Matte Bronze	8x17	4 348:-
	8,5x20	6 492:-		8,5x18	4 876:-
	9x20	6 492:-		8,5X19	5 588:-
	10x20	6 492:-		8,5x20	6 352:-
	10,5x20	6 492:-			
	9x21	7 172:-	TSW Pescara Gloss Black	8,5x18	4 252:-
	10x21	7 172:-		9,5x18	4 252:-
	10,5x21	7 172:-		8,5X19	4 728:-
	11x21	7 172:-		9,5X19	4 728:-
	9x22	7 592:-		8,5x20	5 208:-
	10x22	7 592:-		10x20	5 208:-
	10,5x22	7 592:-			
11x22	7 592:-	TSW PescaraBronze	8,5x18	4 252:-	
9x20	6 492:-		9,5x18	4 252:-	
8,5X19	5 912:-		8,5X19	4 728:-	
9,5X19	5 912:-		9,5X19	4 728:-	
			8,5x20	5 208:-	
TSW Nurburgring Matte Bronze	7,5x17	4 760:-		10x20	5 208:-
	8x17	4 760:-			
	9x17	4 760:-	TSW Rouge Gunmetal/ Mirror Cut Face	8x17	3 920:-
	7,5x18	5 336:-		8,5x18	4 444:-

Modell	Dim.	Pris brutto exkl. moms	Modell	Dim.	Pris brutto exkl. moms
	9,5x18	4 444:-	TSW SweepCandy Red/ Stainless Lip	8,5x20	4 968:-
	8,5x19	5 020:-			
	9,5x19	5 020:-			
	8,5x20	5 596:-	TSW Sweep Gloss Gunmetal/ Stainless Lip	8,5x18	3 984:-
	10x20	5 596:-		9,5x18	3 984:-
TSW Sebring Silver/Mirror Cut Face	8x17	3 488:-		8,5x19	4 420:-
	8,5x18	3 972:-		9,5x19	4 420:-
	9,5x18	3 972:-		8,5x20	4 772:-
	8,5x19	4 444:-		10x20	4 772:-
	9,5x19	4 444:-	TSW SweepMatte Black/ Gloss Black Lip	8,5x18	4 064:-
	8,5x20	4 920:-		9,5x18	4 064:-
	10x20	4 920:-		8,5x19	4 536:-
	9x22	6 016:-		9,5x19	4 536:-
	10,5x22	6 016:-		8,5x20	4 888:-
				10x20	4 888:-
TSW Sebring Matte Black	8x17	3 488:-	TSW Tabac Semi Gloss Black	8x17	3 920:-
	8,5x18	3 972:-		8,5x18	4 184:-
	9,5x18	3 972:-		9,5x18	4 184:-
	8,5x19	4 444:-		8,5x19	4 600:-
	9,5x19	4 444:-		9,5x19	4 600:-
	8,5x20	4 920:-		8,5x20	4 968:-
	10x20	4 920:-		10x20	4 968:-
	9x22	6 016:-			
	10,5x22	6 016:-	TSW Tamburello Matte Black	8,5x19	4 444:-
TSW SilverstoneGloss Black/ Mirror Cut Lip	8x17	3 920:-		9,5x19	4 444:-
	8x18	4 444:-		8,5x20	4 728:-
	9,5x18	4 444:-		10x20	4 728:-
	8x19	5 020:-	TSW Tamburello Matte Bronze	8,5x19	4 444:-
	9,5x19	5 020:-		9,5x19	4 444:-
	8,5x20	5 596:-		8,5x20	4 728:-
	10x20	5 596:-		10x20	4 728:-
	9x22	6 700:-	TSW Tremblant Gloss Black/ Mirror Cut Lip	8x17	3 488:-
TSW Silverstone Silver/ Mirror Cut Face and Lip	8x17	3 920:-		8x18	3 972:-
	8x18	4 444:-		9,5x18	3 972:-
	9,5x18	4 444:-		8x19	4 444:-
	8x19	5 020:-		9,5x19	4 444:-
	9,5x19	5 020:-		8,5x20	4 920:-
	8,5x20	5 596:-		10x20	4 920:-
	10x20	5 596:-	TSW Tremblant Matte Black	8x17	3 488:-
	9x22	6 700:-		8x18	3 972:-
	10,5x22	6 700:-		9,5x18	3 972:-
TSW Snetterton Chrome	8x17	5 124:-		8x19	4 444:-
	8x18	6 492:-		9,5x19	4 444:-
	9,5x18	6 492:-		8,5x20	4 920:-
	8x19	7 016:-		10x20	4 920:-
	9,5x19	7 016:-	TSW Turbina Titanium Silver/ Mirror Cut Face	8x17	4 760:-
	8,5x20	7 592:-		8,5x18	5 336:-
	10x20	7 592:-		9,5x18	5 336:-
TSW Snetterton Hyper Silver/ Mirror Cut Lip	8x17	3 920:-		10x18	5 336:-
	8x18	4 444:-		8,5x19	5 912:-
	9,5x18	4 444:-		9x19	5 912:-
	8x19	5 020:-		9,5x19	5 912:-
	9,5x19	5 020:-		10x19	5 912:-
	8,5x20	5 596:-		8,5x20	6 492:-
	10x20	5 596:-		8,5x20	6 492:-
TSW Sprint Gloss Black/ Mirror Cut Face	8x17	4 076:-		9x20	6 492:-
	8,5x18	4 656:-		10x20	6 492:-
	9,5x18	4 656:-		10,5x20	6 492:-
	8,5x19	5 232:-		11x20	6 492:-
	9,5x19	5 232:-		9x22	7 592:-
	8,5x20	5 808:-		9,5x22	7 592:-
	10x20	5 808:-		10x22	7 592:-
TSW Sprint Gloss Gunmetal	8x17	4 076:-		10,5x22	7 592:-
	8,5x18	4 656:-		11x22	7 592:-
	9,5x18	4 656:-	TSW TurbinaMatte Black	8x17	4 760:-
	8,5x19	5 232:-		8,5x18	5 336:-
	9,5x19	5 232:-		9,5x18	5 336:-
	8,5x20	5 808:-		10x18	5 336:-
	10x20	5 808:-		8,5x19	5 912:-

Modell	Dim.	Pris brutto exkl. moms	Modell	Dim.	Pris brutto exkl. moms
	9X19	5 912:-		9,5X19	5 912:-
	9,5X19	5 912:-		10x19	5 912:-
	10x19	5 912:-		8,5x20	6 492:-
	8,5x20	6 492:-		9x20	6 492:-
	9x20	6 492:-		10x20	6 492:-
	10x20	6 492:-		10,5x20	6 492:-
	10,5x20	6 492:-			
	11x20	6 492:-	Victor Equipment	10,5x22	9 272 k
	9x22	7 592:-	Baden Matte Black	8x18	6 436:-
	9,5x22	7 592:-		10x18	6 436:-
	10x22	7 592:-		10,5x18	6 436:-
	10,5x22	7 592:-		11x18	6 436:-
	11x22	7 592:-		8X19	7 016:-
TSW Vale Silver/Mirror Cut Face	8x17	3 920:-		10x19	7 016:-
	8,5x18	4 444:-		10,5x19	7 016:-
	9,5x18	4 444:-		11x19	7 016:-
	8,5X19	5 020:-		8,5x20	7 592:-
	9,5X19	5 020:-		10x20	7 592:-
	8,5x20	5 596:-		11x20	7 592:-
	10x20	5 596:-		9x21	8 484:-
				10,5x21	8 484:-
				11x21	8 484:-
TSW Vale Double Black - Matte Black/Gloss Black Face	8x17	3 920:-	Victor Equipment Baden Silver/	8x18	6 436:-
	8,5x18	4 444:-		10x18	6 436:-
	9,5x18	4 444:-		10,5x18	6 436:-
	8,5X19	5 020:-		11x18	6 436:-
	9,5X19	5 020:-		8X19	7 016:-
	8,5x20	5 596:-		10x19	7 016:-
	10x20	5 596:-		10,5x19	7 016:-
				11x19	7 016:-
				8,5x20	7 592:-
				10x20	7 592:-
				11x20	7 592:-
				9x21	8 484:-
				10,5x21	8 484:-
				11x21	8 484:-
				10,5x22	9 272:-
TSW Valencia Chrome	8x17	5 124:-	Victor Equipment Fox	8,5X19	11 800:-
	8x18	6 492:-	Brushed Gunmetal	11x19	11 800:-
	9,5x18	6 492:-		9x20	13 700:-
	8X19	7 016:-		11,5x20	13 700:-
	9,5X19	7 016:-		9x21	15 600:-
	8,5x20	7 592:-		11,5x21	15 600:-
	10x20	7 592:-		12x21	15 600:-
			Victor Equipment Fox Matte Black	8,5X19	10 840:-
TSW Valencia Gloss Black/ Mirror Cut Lip	8x17	3 920:-		11x19	10 840:-
	8x18	4 444:-		9x20	12 740:-
	9,5x18	4 444:-		11,5x20	12 740:-
	8X19	5 020:-		9x21	14 700:-
	9,5X19	5 020:-		11,5x21	14 700:-
	8,5x20	5 596:-		12x21	14 700:-
	10x20	5 596:-			
			Victor Equipment LeMans Chrome	8x18	7 488:-
TSW Valencia Matte Black	8x17	3 920:-		9,5x18	7 488:-
	8x18	4 444:-		11x18	7 488:-
	9,5x18	4 444:-		8X19	8 064:-
	8X19	5 020:-		9,5X19	8 064:-
	9,5X19	5 020:-		11x19	8 064:-
	8,5x20	5 596:-		8,5x20	8 588:-
	10x20	5 596:-		10x20	8 588:-
				11x20	8 588:-
				10x22	10 268:-
TSW Valencia Silver/Mirror Cut Lip	8x17	3 920:-	Victor Equipment LeMans Gloss	8x18	5 232:-
	8x18	4 444:-	Black/Mirror Cut Lip	9,5x18	5 232:-
	9,5x18	4 444:-		11x18	5 232:-
	8X19	5 020:-		8X19	5 808:-
	9,5X19	5 020:-		9,5X19	5 808:-
	8,5x20	5 596:-		11x19	5 808:-
	10x20	5 596:-		8,5x20	6 388:-
				10x20	6 388:-
				11x20	6 388:-
				10x22	8 064:-
TSW Variante Gloss Black/ Machined Lip	8,5x18	5 336:-			
	9,5x18	5 336:-			
	8,5X19	5 912:-			
	9X19	5 912:-			
	9,5X19	5 912:-			
	10x19	5 912:-			
	8,5x20	6 492:-			
	9x20	6 492:-			
	10x20	6 492:-			
TSW Watkins Double Black - Matte Black/Gloss Black Face	8,5x18	5 336:-			
	9,5x18	5 336:-			
	8,5X19	5 912:-			
	9X19	5 912:-			

Modell	Dim.	Pris brutto exkl. moms	Modell	Dim.	Pris brutto exkl. moms
Victor Equipment LeMans Hyper Silver/Mirror Cut Lip	8x18	5 232:-	Victor Equipment Wurttemberg Matte Black/Gloss Black Face	9x22	9 848:-
	9,5x18	5 232:-		9,5x22	9 848:-
	11x18	5 232:-		10,5x22	9 848:-
	8X19	5 808:-		11x22	9 848:-
	9,5X19	5 808:-			
	11x19	5 808:-			
	8,5x20	6 388:-			
	10x20	6 388:-			
	11x20	6 388:-			
	10x22	8 064:-			
Victor Equipment Lohner Matte Black	8,5X19	10 840:-			
	11x19	10 840:-			
	9x20	12 740:-			
	11,5x20	12 740:-			
	9x21	14 700:-			
	10x21	14 700:-			
	11,5x21	14 700:-			
	12x21	14 700:-			
Victor Equipment Stabil Gunmetal/Mirror Cut Face	8,5x18	7 016:-			
	10x18	7 016:-			
	10,5x18	7 016:-			
	11x18	7 016:-			
	8,5X19	7 592:-			
	10x19	7 592:-			
	10,5x19	7 592:-			
	11x19	7 592:-			
	8,5x20	8 172:-			
	9x20	8 172:-			
	10x20	8 172:-			
	10,5x20	8 172:-			
	11x20	8 172:-			
	9x21	9 060:-			
	10,5x21	9 060:-			
	11x21	9 060:-			
9x22	9 848:-				
9,5x22	9 848:-				
10,5x22	9 848:-				
Victor Equipment Zehn Hyper Silver	8x18	5 232:-			
	9,5x18	5 232:-			
	11x18	5 232:-			
	8X19	5 808:-			
	9,5X19	5 808:-			
	11x19	5 808:-			
	8,5x20	6 388:-			
	10x20	6 388:-			
	11x20	6 388:-			
	10x22	8 064:-			
	Victor Equipment Zehn Matte Black	11x18	5 232:-		
		8x18	5 232:-		
		9,5x18	5 232:-		
		8X19	5 808:-		
		9,5X19	5 808:-		
		11x19	5 808:-		
8,5x20		6 388:-			
10x20		6 388:-			
11x20		6 388:-			
10x22		8 064:-			
Victor Equipment Zuffen Silver Brushed Face	8,5x18	5 444:-			
	10x18	5 444:-			
	10,5x18	5 444:-			
	11x18	5 444:-			
	8,5X19	6 352:-			
	10x19	6 352:-			
	10,5x19	6 352:-			
	11x19	6 352:-			
	8,5x20	7 020:-			
	10x20	7 020:-			
	11x20	7 020:-			
	9x21	7 784:-			
	10,5x21	7 784:-			
	11x21	7 784:-			
	9,5x22	8 260:-			
	10,5x22	8 260:-			
11x22	8 260:-				
Victor Equipment Zuffen Candy Red	10x20	6 732:-			
	10,5x21	7 404:-			
	10,5x22	7 880:-			
Victor Equipment Zuffen Matte Black	8,5x18	5 064:-			
	10x18	5 064:-			
	10,5x18	5 064:-			
	11x18	5 064:-			
	8,5X19	5 876:-			
	10x19	5 876:-			
	10,5x19	5 876:-			

Modell	Dim.	Pris brutto exkl. moms	Modell	Dim.	Pris brutto exkl. moms
	11x19	5 876:-		9x22	8 776:-
	8,5x20	6 640:-		10,5x22	9 168:-
	10x20	6 640:-			
	11x20	6 640:-	XO Luxury London Candy Red	8,5x19	6 812:-
	9x21	7 256:-		10x19	7 200:-
	10,5x21	7 256:-		9x20	7 460:-
	11x21	7 256:-		10,5x20	7 856:-
	9,5x22	7 592:-		9x22	8 776:-
	10,5x22	7 592:-		10,5x22	9 168:-
	11x22	7 592:-			
XO Luxury Auckland Matte Black	9,5x19	6 060:-	XO Luxury Madrid Matte Black/ Milled Spoke and Brushed Tinted Face	9,5x19	7 248:-
	11x19	6 060:-		11x19	7 248:-
	9x20	7 248:-		9x20	7 856:-
	10,5x20	7 248:-		10x20	7 856:-
	11x20	7 248:-		10,5x20	7 856:-
	10,5x22	8 436:-		11x20	7 856:-
				10,5x22	9 048:-
XO Luxury Cairo Carbon Graphite	8,5x19	7 596:-	XO Luxury New York Gloss Black/Stainless Steel Lip	9x22	8 776:-
	9,5x19	7 596:-		10,5x22	9 168:-
	11x19	7 988:-			
	9x20	8 248:-	XO Luxury New York Matte Silver/ Brushed Face and Stainless Steel Lip	10x20	7 856:-
	9,5x20	8 248:-		9x22	8 776:-
	10x20	8 644:-			
	10,5x20	8 644:-	XO Luxury Phoenix Gunmetal/ Brushed Gunmetal Face	8,5x19	7 596:-
	11x20	8 644:-		9,5x19	7 596:-
	9x21	8 776:-		11x19	7 988:-
	9,5x21	8 776:-		9x20	8 248:-
	10,5x21	9 168:-		9,5x20	8 248:-
	11x21	9 168:-		10x20	8 644:-
				10,5x20	8 644:-
				11x20	8 644:-
XO Luxury Cairo Bronze/ Brushed Bronze Face	8,5x19	7 596:-		9x22	9 560:-
	9,5x19	7 596:-		10,5x22	9 956:-
	11x19	7 988:-		11x22	9 956:-
	9x20	8 248:-	XO Luxury Phoenix Double Black	8,5x19	7 596:-
	9,5x20	8 248:-		9,5x19	7 596:-
	10x20	8 644:-		11x19	7 988:-
	10,5x20	8 644:-		9x20	8 248:-
	11x20	8 644:-		9,5x20	8 248:-
	9x21	8 776:-		10x20	8 644:-
	9,5x21	8 776:-		10,5x20	8 644:-
	10,5x21	9 168:-		11x20	8 644:-
	11x21	9 168:-		9x22	9 560:-
				9,5x22	9 560:-
XO Luxury Helsinki Dark Bronze/ Brushed Bronze Face	8,5x19	6 812:-		10,5x22	9 956:-
	10x19	7 200:-	XO Luxury Verona Matte Black	8,5x19	6 812:-
	9x20	7 460:-		9x19	6 812:-
	10,5x20	7 856:-			9,5x19
	9x22	8 776:-			
	10,5x22	9 168:-		10x19	7 200:-
				11x19	7 200:-
XO Luxury Helsinki Matte Black	8,5x19	6 812:-		8,5x20	7 460:-
	10x19	7 200:-		9x20	7 460:-
	9x20	7 460:-		10x20	7 856:-
	10,5x20	7 856:-		10,5x20	7 856:-
	9x22	8 776:-		11x20	7 856:-
	10,5x22	9 168:-		12x20	7 856:-
				9x22	8 776:-
XO Luxury Helsinki Electric Blue	8,5x19	8 120:-		10,5x22	9 168:-
	10x19	8 512:-	XO Luxury Verona Matte Gunmetal	8,5x19	6 812:-
	9x20	8 776:-		9x19	6 812:-
	10,5x20	9 168:-		9,5x19	6 812:-
	9x22	10 088:-		10x19	7 200:-
	10,5x22	10 480:-		8,5x20	7 460:-
				9x20	7 460:-
XO Luxury London Silver/ Brushed Face	8,5x19	6 812:-		10x20	7 856:-
	10x19	7 200:-		10,5x20	7 856:-
	9x20	7 460:-		11x20	7 856:-
	10,5x20	7 856:-		12x20	7 856:-
	9x22	8 776:-		9x22	8 776:-
	10,5x22	9 168:-		10,5x22	9 168:-
XO Luxury London Matte Black	8,5x19	6 812:-			
	10x19	7 200:-			
	9x20	7 460:-			
	10,5x20	7 856:-			

Modell	Dim.	Pris brutto exkl. moms	Modell	Dim.	Pris brutto exkl. moms
XO Luxury Verona Matte Silver/ Brushed Face	9,5x19	6 812:-			
	9x20	7 460:-			
	10,5x20	7 856:-			
	11x20	7 856:-			
	12x20	7 856:-			
	9x22	8 776:-			
Ohm Lightning Gloss Black	8,5x18	4 876:-			
	8,5x19	5 588:-			
	9x20	6 400:-			
	10x20	6 400:-			
	9x21	7 020:-			
	10,5x21	7 020:-			
	9x22	7 448:-			
	10,5x22	7 448:-			
11x22	7 448:-				
Ohm Lightning Gloss Gunmetal	8,5x18	4 876:-			
	8,5x19	5 588:-			
	9x20	6 400:-			
	10x20	6 400:-			
	9x21	7 020:-			
	10,5x21	7 020:-			
	9x22	7 448:-			
	10,5x22	7 448:-			
11x22	7 448:-				
Ohm Proton Gloss Black	6,5x17	4 348:-			
	7x17	4 348:-			
	8,5x18	4 780:-			
	8,5x19	5 496:-			
	9x20	6 068:-			
	10x20	6 068:-			
	9x21	6 784:-			
	10,5x21	6 784:-			
	9x22	7 260:-			
	10,5x22	7 260:-			
	11x22	7 260:-			
Ohm Proton Silver/Mirror Face	6,5x17	4 636 :-			
	7x17	4 636 :-			
	8,5x18	5 064 :-			
	8,5x19	5 780 :-			
	9x20	6 352 :-			
	10x20	6 352 :-			
	9x21	7 068 :-			
	10,5x21	7 068 :-			
	9x22	7 640 :-			
	10,5x22	7 640 :-			
	11x22	7 640 :-			

Modell	Dim.	Pris brutto exkl. moms	Modell	Dim.	Pris brutto exkl. moms
Performance Line					
ATS Crosslight	8,5x19	3 732:-			
	9x19	3 924:-			
	10x19	4 120:-			
	11,5x19	4 220:-			
ATS Racelight Blk	8,5x19	3 372:-			
	10x19	3 548:-			
	11x19	3 704:-			
	8,5x20	3 856:-			
	10x20	4 076:-			
	11x20	4 340:-			
ATS Racelight Slv	8,5x19	3 400:-			
	10x19	3 556:-			
	11x19	3 704:-			
	8,5x20	3 856:-			
	10x20	4 072:-			
	11x20	4 340:-			
Design Line					
ATS Grid Blk/Pol	8x18	2 832:-			
	8,5x19	3 388:-			
	8,5x20	4 224:-			
ATS Perfektion Blk/Pol	8x18	2 720:-			
	8,5x19	3 220:-			
	9x20	4 084:-			
ATS Perfektion Slv	8x19	3 052:-			
	9x19	3 444:-			
ATS Temperament Grey	9x19	3 248:-			
ATS Temperament Slv	9x19	2 888:-			
	9,5x20	3 528:-			
ATS Radial (Porsche) (Porsche)	7x16	1 492:-			
	8x18	2 932:-			
	10x18	3 268:-			
	9x20	3 400:-			
ATS Streeutralye Grey	6x15	1 240:-			
	6x16	1 336:-			
	6,5x16	1 336:-			
	7x17	1 764:-			
	7,5x18	2 168:-			
ATS Streeutralye Black	7x17	1 764:-			
	7,5x18	2 168:-			
ATS Streeutralye Silver	6x15	1 240:-			
	6x16	1 336:-			
	6,5x16	1 336:-			
ATS Streeutralye White	7x17	1 764:-			
	7,5x18	2 168:-			
ATS Auvora Slv	6,5x16	1 288:-			
	6,5x17	1 460:-			
	7,5x17	1 460:-			
	8x18	1 648:-			
	8x19	2 060:-			
ATS Auvora Grey	6,5x16	1 316:-			
	6,5x17	1 488:-			
	7,5x17	1 488:-			
	8x18	1 680:-			
	8x19	2 080:-			
Classic Line					
ATS Cup	7x15	3 672:-			
	8x18	2 948:-			
ATS Classic	7x13	3 672:-			
	8x13	3 808:-			
	5,5x15	3 952:-			



1. Nitro Aero FF G.Blk



2. Nitro Aero FF G.Gun/Pol



3. Nitro Aero FF D.Slv



4. Nitro Throne FF



5. Nitro Sapphire FF



6. Nitro Turismo FF



7. Nitro Turismo FF G.Gun/Pol



8. Nitro Volcano G.Gun



9. Nitro Volcano



10. Nitro Spark G.Blk/Grey



11. Nitro Spark G.Blk/Red



12. Nitro Sabre G.Blk



13. Nitro Magnum



14. Advanti Inizio DST



15. ATS Antares

FÖR AUDI

FÖR AUDI



16. ATS Antares G.Blk

FÖR BMW & MINI



17. ATS Evolution

FÖR BMW & MINI



18. ATS Evolution G.Grey

FÖR MERCEDES



19. ATS Mizar

FÖR MERCEDES



20. ATS Mizar G.Blk

FÖR BMW & MINI



21. CSP 18 G.Blk/Pol

FÖR BMW & MINI



22. CSP 18

FÖR BMW & MINI



23. CSP 18 G.Blk

FÖR VW



24. CSP 13

FÖR VW



25. CSP 13 M.Gun

FÖR MERCEDES



26. CSP 15

FÖR MERCEDES



27. CSP 15 M.Blk



28. CSP 16



29. CSP 16 M.Gun



30. Image Colt



31. Image Colt L.Gun

FÖR MERCEDES



32. Image Star FF G.Blk/Pol

FÖR MERCEDES



33. Image Star FF L.Gun

FÖR MERCEDES



34. Image Star FF Slv



35. Image Comet G.Blk/Pol



36. Image Comet



37. Image Comet Slv



38. Image Thor

FÖR SLÄP & HUSVAGN



39. Image Ride HL M.Gun

FÖR SLÄP & HUSVAGN



40. Image Ride

FÖR SLÄP & HUSVAGN



41. Image Ride Blk/Pol



42. Image Stella



43. Image Stella M.Blk



44. Image Legend



45. Image Motion



46. Image Motion G.Gun



47. Image Brio



48. Image Spirit

FÖR MOPEDBIL



49. Image Rebel

FÖR MOPEDBIL



50. Image Rebel M.Blk

SUV & 4+4



51. Nitro Hammer

SUV & 4+4



52. Image Vector Blk/Pol

SUV & 4+4



53. Image Vector

SUV & 4+4



54. Image Vector Slv

SUV & 4+4



55. Image Strong G.Blk/Pol

SUV & 4+4



56. Image Strong

SUV & 4+4



57. Image Strong M.Gun

SUV & 4+4



58. Image Solid Gun/Pol

SUV & 4+4



59. Image Solid

SUV & 4+4



60. Image Montana G.Blk

SUV & 4+4



61. Image Montana Slv

SUV & 4+4



62. Image Rock G.Blk/Pol

SUV & 4+4



63. Image Rock

SUV & 4+4



64. BM Macho

SUV & 4+4



65. BM Macho M.Blk

SUV & 4+4



66. Ballistic Dakota Blk/Pol

SUV & 4+4



67. Ballistic Dakota

SUV & 4+4



68. Ballistic Morax

SUV & 4+4



69. Ballistic Guillotine

SUV & 4+4



70. Ballistic Ravage

FÖR BMW



71. CSP 10

FÖR BMW



72. CSP 10 M.Blk



73. CSP Work

SUV & 4+4



74. Advanti Peak



75. MSW 50 G.Blk



76. MSW 48 M.Blk



77. MSW 40 Blk/Pol



78. MSW 30 G.Blk F.Pol



79. MSW 27T G.Gun



80. MSW 27T G.Blk/Pol



81. MSW 79 Blk/Pol



82. MSW 85 G.Blk



83. MSW 77 Matt Grey



84. MSW 55 M.Dark Grey



85. MSW 48 Van Blk/Pol



86. MSW 48 Van



88. Sparco Dakar

SpecialWheels

Specialfälgar i Kungsbacka AB

Borgåsvägen 2

434 39 Kungsbacka

Tel. 0300-729 00

www.specialwheels.com