



NYHETER INFÖR HÖSTEN 2022

IMAGE DYNAMIC – Ny modell från Image Wheels! Modern fälg med fem trendigt kantiga dubbelekrar. Finns i silver, blank grå metallic och svart.

ATS COMPETITION 2 – Sportig fälg med fem dubbelekrar från tyska ATS. Lackad i mattsvart och med polerad kant. TÜV-godkänd.

ATS PASSION – Mycket sportig och modernt designad ny modell från tyska ATS! Finns i mörkgrå metallic och blanksvart med polerad front. TÜV-godkänd.

ETA BETA COMBAT M.BLK – Ny fräck fälg i mattsvart till SUV och pickup från Eta Beta!



114. ATS Competition 2 M.Blk/Pol Lip



115. ATS Passion D.Grey



117. Eta Beta Combat M.Blk



118. Image Dynamic G.Blk

Lättviktsfälgar – viktexempel

Fälgmodell	Vikt kg/st	Fälgmodell	Vikt kg/st	Fälgmodell	Vikt kg/st
Nitro Throne FF		Nitro Turismo FF		Nitro Aero FF	
8,5x20 5-108 E40 C63,3	11,9	8x19 5-108 E50 C63,3	11,2	8,5x18 5-114,3 E40 C70/64	10,7
9x20 5-108 E40 C63,3	12,3	8,5x19 5-108 E45 C63,3	12,1	8x19 5-120 E40 C64,1	11,8
10x20 5-112 E40 C66,4	12,1	9x19 5-108 E53 C63,3	11,7	8,5x19 5-114,3 E40 CC70/64	11,8
10,5x20 5-112 E40 C66,4	12,7	9,5x19 5-112 E50 C66,5	12,3	8x20 5-108 E50 C63,3	12,3
9x22 5-108 E40 C63,3	13,6	10x19 5-112 E50 C66,5	12,4	8,5x20 5-114,3 E35 CC70/64	13,3
10,5x22 5-112 E40 C66,4	14,5	10,5x19 5-112 E25 C66,5	13,2	9x20 5-108 E53 C63,3	13,3
11x22 5-112 E45 C66,4	14,4	8x20 5-108 E50,5 C63,3	12,5		
		8,5x20 5-108 E45 C63,3	13,1		
Nitro Sapphire FF		9x20 5-108 E58,5 C63,3	13,1		
7,5x18 5-108 E50 C63,3	10,1	9,5x20 5-130 E64 C71,6	13,1		
8x18 5-108 E42 C63,3	11	10x20 5-112 E50 C66,5	13,6		
8,5x18 5-114,3 E40 C64,1	11,3	10,5x20 5-130 E64 C71,5	13,2		
7,5x19 5-108 E50 C63,3	11,3	11x20 5-130 E58 C71,5	13,6		
8x19 5-108 E42 C63,3	11,5	11,5x20 5-130 E64 C71,5	14,1		
8,5x19 5-108 E56 C63,3	11,6				
8x20 5-108 E50 C63,3	12,8				
8,5x20 5-108 E47 C63,3	12,8				
9x20 5-108 E53 C63,3	13,4				



4. Nitro Throne FF



5. Nitro Sapphire FF



6. Nitro Turismo FF



3. Nitro Aero FF D.Slv

INNEHÅLLSFÖRTECKNING

	Sid.
OE-anpassade fälgar	4-5
Caps – Emblem	
Advanti	6-7
CSP	7-8
Nitro	9-11
BM Wheels	12-13
Team Dynamics	13
Ballistic, Incubus & PCW	14
Image	15-17
Breyton	18
ATS	19
4X4	19
Spacers	20
Mutter – Bult – Fälg lås	21-23
Bimecc OE mutter och bult	24-38
Monteringstillbehör Italmatic	39-45
Mätverktyg	45
Speedline Truck ventiler och ventilförlängare	46
Centreringsringar	47
Satser	48-50
Villkor	51
Stålfälgar för lastbilar bussar och släpvagnar	52-53
Speedline Truck lastbilsfälgar	54-55
Priser alu-fälgar PV	56
Fälgguiden	57
Sortiment	58-63



**Nitro Aero FF G.Blk, Nitro Aero FF G.Gun/Pol
och Nitro Aero FF D.Slv**
OE-anpassad för Tesla kåpa 6005879-00A
OE-anpassad för BMW kåpa 36136850834
OE-anpassad för Mini kåpa 36131171069
OE-anpassad för Volvo kåpa 31400897



Nitro Sapphire FF
OE-anpassad för Audi kåpa 480601170A
OE-anpassad för Volvo kåpa 31400897 Grey / 31471435 Slv



**Nitro Throne FF och
Nitro Throne FF G.Blk**
OE anpassad för Volvo cap cap 31400897



Nitro Turismo FF och Nitro Turismo FF G.Gun/Pol
Alla 5-108 är OE-anpassade för Volvo, kåpa 31471435 Slv och 31400897 Grey
Alla 5-112 listade på BMW är OE-anpassade för BMW, kåpa 36136850834
Alla 5-112 listade på MINI är OE-anpassade för MINI, kåpa 36131171069
Alla 5-112 listade på Porsche Macan är OE-anpassade för kåpa 95B60115188Z
Alla 5-120 är OE-anpassade för BMW, kåpa 36136783536



Nitro Volcano och Nitro Volcano G.Gun
Alla 5-108 är OE-anpassade för Volvo, kåpa 31471435 Slv och 31400897 Grey
Alla 5-112 listade på Audi är OE-anpassade för Audi, kåpa 4B0601170A
Alla 5-112 listade på BMW är OE-anpassade för BMW, kåpa 36136850834
Alla 5-120 är OE-anpassade för BMW, kåpa 36136783536



Nitro Sting FF Slv och Nitro Sting FF G.Blk
OE-anpassad för Tesla kåpa 6005879-00A
OE-anpassad för BMW kåpa 36136850834
OE-anpassad för Mini kåpa 36131171069
OE-anpassad för Volvo kåpa 31400897



Nitro Sabre G.Blk
OE-anpassad för Audi kåpa 4B0601170A



**MSW 27T G.Gun och
MSW 27T G.Blk
MSW 27T G.Blk/Pol**
OE-anpassad för Tesla 3 & Y kåpa 6005879-00-A



MSW 30 G.Blk/F.Pol
OE-anpassad för Mercedesers kåpa A170400025 / 2014010225 / A1714000122



MSW 50 G.Blk
OE-anpassad BMW / Mini 686109201 / 685083401 / 685714901
OE-anpassad för Volvo 31445779 / 31400897



MSW 80 G.Blk och MSW 80 G.Blk/Pol
Vissa 5-108 är OE-anpassade för Volvo, kåpa 31471435 Slv och 31400897 Grey
Vissa 5-112 är OE-anpassade för Audi kåpa 4B0601170A och Volkswagen kåpa 3B7601171
Vissa 5-112 är OE-anpassade BMW / Mini 686109201 / 685083401 / 685714901



MSW 41 G.Blk och MSW 41 G.Blk/Pol
Vissa 5-108 är OE-anpassade för Volvo, kåpa 31471435 Slv och 31400897 Grey
Vissa 5-112 är OE-anpassade för Audi kåpa 4B0601170A
och Volkswagen kåpa 3B7601171
Vissa 5-112 är OE-anpassade BMW / Mini 686109201 / 685083401 / 685714901



MSW 42 G.Blk och MSW 42 G.Blk/Pol
Vissa 5-108 är OE-anpassade för Volvo, kåpa 31471435 Slv och 31400897 Grey
Vissa 5-112 är OE-anpassade för Audi kåpa 4B0601170A
och Volkswagen kåpa 3B7601171
Vissa 5-112 är OE-anpassade BMW / Mini 686109201 / 685083401 / 685714901
MSW 74 G.Blk och MSW 74 G.Blk/Pol
Vissa 5-112 är OE-anpassade BMW / Mini 686109201 / 685083401 / 685714901
Vissa 5-114,3 är OE-anpassade för Tesla 3 & Y, kåpa 6005879-00-A



Eta Beta Amos G.Bik/Pol
Alla 5-108 är OE-anpassade för Volvo, kåpa 31471435 Slv och 31400897 Grey



Sparco Dakar
OE-anpassad för Suzuki Jimny



**Image Star FF G.Bik/Pol,
Image Star FF L.Gun och
Image Star FF Slv**
OE-anpassad för Mercedes kåpa B66470202 / B66470200



Image Vector och Image Vector Slv
OE-anpassad för VW 3B7601171
Image Rock
OE-anpassad för Mercedes X-class kåpa A4704000200



Image Stella och Image Stella M.Bik
Alla 5-108 är OE-anpassade för Volvo, kåpa 31471435 Slv och 31400897 Grey



Image Atom Slv och Image Atom G.Gun
Anpassad för VAG, 5-100 - kåpa 1J0601171, 5-112 - kåpa 3B7601171,
Volvo 5-108 - kåpa 31471435 Silver och 31400897 Grey



Image Thor
Alla 5-108 är OE-anpassade för Volvo, kåpa 31471435 Slv och 31400897 Grey



ATS Antares och ATS Antares G.Bik
Alla 5-112 är OE anpassade för Audi, kåpa 4B0601170A



ATS Evolution och ATS Evolution G.Grey
OE-anpassad fälg för BMW och MINI
Alla 5-112 listade på BMW är OE-anpassade för BMW, kåpa 36136850834
Alla 5-112 listade på MINI är OE-anpassade för MINI, kåpa 36131171069
Alla 5-120 är OE-anpassade för kåpa 36136783536



ATS Perfektion M.Bik och ATS Perfektion D.Grey
OE-anpassad för Tesla Y, kåpa 6005879-00-A



ATS Mizar och ATS Mizar G.Bik
OE-anpassad fälg för Mercedes
Silver kåpa B66470202
Svart kåpa B66470200



CSP 13 och CSP 13 M.Gun
OE-anpassad fälg för Volkswagen
Alla 5-100 är OE-anpassade för kåpa 1J0601171
Alla 5-112 är OE-anpassade för kåpa 3B7601171



CSP 15 och CSP 15 M.Bik
OE-anpassad fälg för Mercedes
Silver kåpa B66470202
Svart kåpa B66470200



CSP 18, CSP 18 G.Bik och CSP 18 G.Bik/Pol
OE-anpassad fälg för BMW och MINI
Alla 5-112 listade på BMW är OE-anpassade för BMW, kåpa 36136850834
Alla 5-112 listade på MINI är OE-anpassade för MINI, kåpa 36131171069
Alla 5-120 är OE-anpassade för kåpa 36136783536

Advanti



Bild	Modell	Märkning	Ytter dia. (mm)	Inner dia. (mm)	Djup (mm)	Pris Exkl.	Cap + Logo	Cap	Logo
4	Advanti Falcon*	PC286-1-C Beskrivning: Advanti Racing Blk	110 total		106 höjd Dia. (mm): 60 kvx	160:-	x	07005046	x
7	Advanti Forza	C590 Beskrivning: Advanti Racing Car	55	50	11 Dia. (mm): 56 plan	100:-	07005028	07005029	x
2	Advanti Nebullar*	PC993 Beskrivning: Advanti Blk	69 total		10 höjd Dia. (mm): 50 plan	100:-	07005043	x	x
8	Advanti Nova (6-114)	C118-2-20 Beskrivning: Advanti Blk	113 total		Dia. (mm): 37 plan	160:-	07005093	x	07006027
8	Advanti Nova (6-139,7)	C118-1-20 Beskrivning: Advanti Blk	137 total		Dia. (mm): 54 plan	160:-	x	x	07006028
7	Advanti Black Pearl	XC287CH Beskrivning: Advanti Racing G.Blk	62,5	57,6	Dia. (mm):	100:-	x	07005004	x
12	Advanti Inizio DST	XC647VW M.Blk Beskrivning: Advanti Blk			Dia. (mm): 60 kvx	100:-	x	07005124	07006047
9	Advanti Pulsar (6-114)	C118-2-20 Beskrivning: Advanti Blk	113 total		Dia. (mm): 37 plan	160:-	07005099	x	07006027
3	Advanti Raid/Peak	C-098-A Beskrivning: Advanti Racing Slv	71,2	63,7	14,3 Dia. (mm): 62 kvx	100:-	07005047	x	07006022
3	Advanti Raid (5-112)	XC585A-C Beskrivning: Advanti Racing Slv			Dia. (mm): 60 kvx	100:-	x	07005007	x
6	Advanti Raptor	XC287C Beskrivning: Advanti Racing Car	62,5	57,6	9,7 Dia. (mm): 62 kvx	100:-	07005080	07005016	x
11	Advanti Siren	C398-MGM6 Beskrivning: Advanti Racing Car			Dia. (mm): 65 kvx	100:-	x	07005114	x
9	Advanti Titan (6-114)	C398C Beskrivning: Advanti Racing Slv			Dia. (mm): 62 kvx	160:-	x	07005034	07006041
9	Advanti Titan (6-139,7)	C118-1-20 Beskrivning: Advanti Blk	137 total		Dia. (mm): 54 plan	160:-	x	07005102	07006028
9	Advanti Titan M.Gun (5-139,7)	C118-6-20 Beskrivning: Advanti Blk			Dia. (mm): 54 plan	160:-	07005150	x	x
9	Advanti Titan M.Gun (6-114)	C398-MGM6 Beskrivning: Advanti Blk			Dia. (mm): 62 kvx	160:-	x	07005114	x
10	Advanti Viper / Trophy*	C287 Beskrivning:	62	57	10 Dia. (mm): 62 kvx	100:-	07005026	07005016	07006003
5	Advanti Vulkan*	C287 Beskrivning: Advanti Racing Slv	62,5	57,6	9,7 Dia. (mm): 62 kvx	100:-	07005026	07005016	07006003

* Utgår vid slut

CSP



Bild	Modell	Märkning	Ytter dia. (mm)	Inner dia. (mm)	Djup (mm)	Pris Exkl.	Cap + Logo	Cap	Logo
2	CSP 5/Trailer	PCF56 Beskrivning: CSP Slv	62,5	57,4	8,6 Dia. (mm): 60 plan	100:-	x	07005068	07006051
2	CSP 5/Trailer 4/5-100	PCF86-C Beskrivning: CSP Slv	56,5	51	8,9 Dia. (mm): 60 plan	100:-	x	07005069	07006051
1	CSP 6*	C-G96 Beskrivning: CSP Slv	65	60	9,4 Dia. (mm): 62 kvx	100:-	x	07005053	x
1	CSP 7/11 5-112*	A05 Beskrivning: CSP Slv	56,5 59,6	51	10 Dia. (mm): 60 kvx	100:-	09005055	09005043	x
1	CSP 8 PCD <100	PCW3B Beskrivning: CSP Slv	55	50	8 Dia. (mm): 55 kvx	100:-	09005058	09005003	09006008
1	CSP 8 PCD >100	PCW3B-60 Beskrivning: CSP Slv	62	57	9 Dia. (mm): 65 kvx	100:-	09005059	09005038	x
1	CSP Work <100	PCW3B Beskrivning: CSP Slv	55	50	9 Dia. (mm): 55 kvx	100:-	09005058	09005003	09006008
1	CSP Work >100	PCW3B-60 Beskrivning: CSP Slv	62	56	10,5 Dia. (mm): 64 kvx	100:-	09005060	09005038	09006019
1	CSP Work (Et 62)	Mercy Polos Beskrivning: CSP Slv			70 plan Dia. (mm): 70 plan	100:-	09005063	09005061	09006024
3	CSP 10	C-043 Beskrivning: CSP Slv	67	60	12 Dia. (mm): 62 plan	100:-	02005008	x	x
3	CSP 10 (5-112)	C-137 Beskrivning: CSP Slv	53	46,7	10,8 Dia. (mm): 53 plan	100:-	02005037	02005035	02006032
4	CSP 10 M.Blk	C-043 Beskrivning: CSP Blk	67	60	12 Dia. (mm): 62 plan	100:-	02005016	02005015	02006008
4	CSP 10 M.Blk (5-112)	C-137 Blk Beskrivning: CSP Blk	53	46,7	10,8 Dia. (mm): 53 plan	100:-	02005038	02005036	02006033
6	CSP 12	VV-05 Beskrivning: CSP Slv	62,2	56,5	15,6 Dia. (mm): 63 plan	100:-	02005013	x	x
5	CSP 12 M.Gun	VV-05 Beskrivning: CSP Blk	62,2	56,5	15,6 Dia. (mm): 63 plan	100:-	02005014	x	x
	CSP 13 (5-100)	XC648VW Beskrivning: CSP Slv			50 kvx Dia. (mm): 50 kvx	100:-	07005160	07005161	07006074
3	CSP 13	XC647VW Beskrivning: CSP Slv			60 kvx Dia. (mm): 60 kvx	100:-	07005125	07005123	07006070
	CSP 13 M.Gun (5-100)	XC648VW Blk Beskrivning: CSP Blk			50 kvx Dia. (mm): 50 kvx	100:-	07005162	07005163	07006075
4	CSP 13 M.Gun	XC647VW Blk Beskrivning: CSP Blk			60 kvx Dia. (mm): 60 kvx	100:-	07005126	07005124	07006071
3	CSP 14	XC566VW Beskrivning: CSP Slv			60 kvx Dia. (mm): 60 kvx	100:-	07005129	07005127	07006070
4	CSP 14 M.Blk	XC566VW Blk Beskrivning: CSP Blk			60 kvx Dia. (mm): 60 kvx	100:-	07005130	07005128	07006071
3	CSP 15	R200 Beskrivning: CSP Slv			60 kvx Dia. (mm): 60 kvx	100:-	07005120	07005081	07006068

* Utgår vid slut

CSP

Bild	Modell	Märkning	Ytter dia. (mm)	Inner dia. (mm)	Djup (mm)	Pris Exkl.	Cap + Logo	Cap	Logo
4	CSP 15 M.Blk	R200 blk Beskrivning: CSP Blk			Dia. (mm): 60 kvx	100:-	07005121	07005122	07006069
3	CSP 16 PCD <100	PCW3B Beskrivning: CSP Slv	55	50	Dia. (mm): 55 kvx	100:-	09005120	09005003	09006027
3	CSP 16 PCD >100	PCW3B-60 Beskrivning: CSP Slv	62	57	Dia. (mm): 65 kvx	100:-	09005121	09005038	09006028
4	CSP 16 M.Gun PCD <100	PCW3B FSDG Beskrivning: CSP Blk	55	50	Dia. (mm): 55 kvx	100:-	09005069	09005068	09006029
4	CSP 16 M.Gun PCD >100	PCW3B-60 FSDG Beskrivning: CSP Blk	62	57	Dia. (mm): 65 kvx	100:-	09005071	09005070	09006030
6	CSP 17	WV-05 Beskrivning: CSP Slv	62,2	56,5	Dia. (mm): 63 plan	100:-	02005013	x	x
6	CSP 17 G.Blk/Pol	WV-05 Beskrivning: CSP Slv	62,2	56,5	Dia. (mm): 63 plan	100:-	02005014	x	x
	CSP 18 (5-112)	C-137 Beskrivning: CSP Slv	53	46,7	Dia. (mm): 53 plan	100:-	02005078	02005077	02006032
	CSP 18 (5-120)	C-043 Beskrivning: CSP Slv	67	60	Dia. (mm): 62 plan	100:-	02005076	02005075	02006006
	CSP 18 G.Blk (5-112)	C-137 Beskrivning: CSP G.Blk	53	46,7	Dia. (mm): 53 plan	100:-	02005082	02005081	02006048
	CSP 18 G.Blk (5-120)	C-043 Beskrivning: CSP G.Blk	67	60	Dia. (mm): 62 plan	100:-	02005080	02005079	02006047
	CSP 18 G.Blk/Pol (5-112)	C-137 Beskrivning: CSP G.Blk	53	46,7	Dia. (mm): 53 plan	100:-	02005082	02005081	02006048
	CSP 18 G.Blk/Pol (5-120)	C-043 Beskrivning: CSP G.Blk	67	60	Dia. (mm): 62 plan	100:-	02005080	02005079	02006047

* Utgår vid slut



Nitro



Bild	Modell	Märkning	Ytter dia. (mm)	Inner dia. (mm)	Djup (mm)	Pris Exkl.	Cap + Logo	Cap	Logo
	Nitro Aero D.Slv (5-108)	C-154 Beskrivning: Nitro D.Slv			Dia. (mm): 63 kvx	100,-	02005093	02005083	02006061
	Nitro Aero D.Slv (5-114/120 Cb 64,1)	C-159 Beskrivning: Nitro D.Slv			Dia. (mm): 57 plan	100,-	02005046	02005045	02006053
	Nitro Aero D.Slv	C-137 D.Slv Beskrivning: Nitro D.Slv			Dia. (mm): 53 kvx	100,-	02005097	02005077	02006058
	Nitro Aero G.Blk (5-108)	C-154 Beskrivning: Nitro G.Blk			Dia. (mm): 63 kvx	100,-	02005092	02005083	02006059
	Nitro Aero G.Blk (5-114/120 Cb 64,1)	C-159 Beskrivning: Nitro G.Blk			Dia. (mm): 57 plan	100,-	02005048	02005045	02006054
	Nitro Aero G.Blk	C-137 G.BLK Beskrivning: Nitro G.Blk			Dia. (mm): 53 kvx	100,-	02005094	02005081	02006056
	Nitro Aero G.Gun/Pol (5-108)	C-154 Beskrivning: Nitro G.Gun			Dia. (mm): 63 kvx	100,-	02005005	02005083	02006060
	Nitro Aero G.Gun/Pol (5-114/120 Cb 64,1)	C-159 Beskrivning: Nitro G.Gun			Dia. (mm): 57 plan	100,-	02005049	02005045	02006055
5	Nitro Daytona*	C-015 Beskrivning: Nitro Slv			Dia. (mm): 55 kvx	100,-	02005025	02005029	02006031
7	Nitro Demon Pcd <112	XC566VW Blk Beskrivning: Nitro Blk			Dia. (mm): 60 kvx	100,-	07005132	07005128	07006072
7	Nitro Demon Pcd >110	XC287MB Beskrivning: Nitro Blk	62,5	57,6	9,7 Dia. (mm): 62 kvx	100,-	07005134	07005106	07006073
6	Nitro Demon H.Slv Pcd <112	XC566VW Beskrivning: Nitro Slv			Dia. (mm): 60 kvx	100,-	07005131	07005127	07006024
6	Nitro Demon H.Slv Pcd >110	XC287 Beskrivning: Nitro Slv	62,5	57,6	9,7 Dia. (mm): 62 kvx	100,-	07005133	07005004	07006015
4	Nitro Edge	C398-MGM6 Beskrivning: Nitro Blk			Dia. (mm): 65 kvx	100,-	07005117	07005114	07006034
4	Nitro Edge M.Blk	C398-MB Beskrivning: Nitro Blk			Dia. (mm): 65 kvx	100,-	x	07005017	07006034
6	Nitro Epic (5-108)	VV-05 Beskrivning: Nitro Slv	62,2	56,5	15,6 Dia. (mm): 63 kvx	100,-	x	x	02006038
6	Nitro Epic (5-112 Et 21)	C-140 Beskrivning: Nitro Slv	47	44	12,5 Dia. (mm): 60 plan	100,-	x	02005062	02006036
6	Nitro Epic (5-112)	C-284-1 Beskrivning: Nitro Slv	55	48,4	8 Dia. (mm): 60 plan	100,-	x	02005002	02006036
6	Nitro Epic (5-120 - 5-130)	C-043 Beskrivning: Nitro Slv	67	60	12 Dia. (mm): 62 kvx	100,-	02005060	x	02006037
6	Nitro Epic M.Gun (5-108)	VV-05 Beskrivning: Nitro Blk	62,2	56,5	15,6 Dia. (mm): 63 kvx	100,-	x	02005011	02006039

* Utgår vid slut

Nitro

Bild	Modell	Märkning	Ytter dia. (mm)	Inner dia. (mm)	Djup (mm)	Pris Exkl.	Cap + Logo	Cap	Logo
6	Nitro Epic M.Gun (5-112 Et 21) Beskrivning: Nitro Blk	C-140 Blk	47	44	12,5 Dia. (mm): 60 plan	100:-	x	02005063	02006012
6	Nitro Epic M.Gun (5-112) Beskrivning: Nitro Blk	C-284-1	55	48,4	8 Dia. (mm): 60 plan	100:-	02005055	02005002	02006012
7	Nitro Epic M.Gun (5-120 - 5-130) Beskrivning:	C-043 Blk	67	60	12 Dia. (mm): 62 kvx	100:-	x	02005015	02006035
4	Nitro Hammer Beskrivning: Nitro Blk	C398-MGM6				100:-	07005117	07005114	07006034
4	Nitro Magnum Beskrivning: Nitro Blk	C398-MGM6				100:-	07005117	07005114	07006034
4	Nitro Magnum HL Beskrivning: Nitro Blk	C398-MGM6				100:-	07005117	07005114	07006034
3	Nitro Mystic* Beskrivning: Nitro Slv	XC987-MB	64,8	60	16,2 Dia. (mm): 49 plan	100:-	x	07005008	07006025
1	Nitro Octane* Beskrivning: Nitro Slv	C-284-1	55	48,4	7,8 Dia. (mm): 60 plan	100:-	x	02005002	02006002
6	Nitro Razor Pcd <112 Beskrivning: Nitro Slv	XC566VW				100:-	07005131	07005127	07006024
6	Nitro Razor Pcd >110 Beskrivning: Nitro Slv	XC287CH	62,5	57,6	9,7 Dia. (mm): 62 kvx	100:-	07005133	07005004	07006015
7	Nitro Razor M.Gun Pcd <112 Beskrivning: Nitro Blk	XC566VW-MB				100:-	07005132	07005128	07006072
7	Nitro Razor M.Gun Pcd >110 Beskrivning: Nitro Blk	XC287-MB	62,5	57,6	9,7 Dia. (mm): 62 kvx	100:-	07005134	07005106	07006073
8	Nitro Sabre (5-108/112) Beskrivning: Nitro Bronze	XC566V-BR				100:-	07005146	07005147	07006039
8	Nitro Sabre (5-114/120) Beskrivning: Nitro Bronze	CXC287-BR	62,5	57,6	9,7 Dia. (mm): 62 kvx	100:-	07005148	07005149	07006040
9	Nitro Sabre G.Blk (5-114) Beskrivning: Nitro G.Blk	XC287-GB				100:-	07005082	07005083	07006108
9	Nitro Sabre G.Blk Beskrivning: Nitro G.Blk	XC566VW-GB				100:-	07005042	07005041	07006107
11	Nitro Sapphire FF (5-108) Beskrivning: Nitro G.Gun	XC VOL-GM				100:-	07005169	07005175	07006079
11	Nitro Sapphire FF Beskrivning: Nitro G.Gun	XC566VW-G.Gun				100:-	07005084	07005085	07006080
9	Nitro Spark (5-108) Beskrivning: Nitro G.Blk	C398-G.Blk				100:-	07005157	07005158	07006042
9	Nitro Spark Beskrivning: Nitro G.Blk	C073A-G.Blk				100:-	07005155	07005156	07006042
9	Nitro Spark G.Blk/Grey (5-108) Beskrivning: Nitro G.Blk	C398-G.Blk				100:-	07005157	07005158	07006042
9	Nitro Spark G.Blk/Grey Beskrivning: Nitro G.Blk	C073A-G.Blk				100:-	07005155	07005156	07006042
9	Nitro Spark G.Blk/Red (5-108) Beskrivning: Nitro G.Blk	C398-G.Blk				100:-	07005157	07005158	07006042
9	Nitro Spark G.Blk/Red Beskrivning: Nitro G.Blk	C073A-G.Blk				100:-	07005155	07005156	07006042
4	Nitro Speed Beskrivning: Nitro Blk	C398-MGM6				100:-	07005117	07005114	07006034
4	Nitro Speed M.Gun Beskrivning: Nitro Blk	C398-MGM6				100:-	07005117	07005114	07006034
2	Nitro Sprint Pcd 100/108* Beskrivning: Nitro Slv	XC-585	54	51	10,6 Dia. (mm): 50 kvx	100:-	07005077	07005006	07006023
2	Nitro Sprint Pcd >110* Beskrivning: Nitro Slv	XC585A	62,5	57,6	9,5 Dia. (mm): 60 kvx	100:-	07005078	07005007	07006024
6	Nitro Spyder (5-108) Beskrivning: Nitro Slv	VV-05	62,2	56,5	15,6 Dia. (mm): 63 kvx	100:-	02005067	x	x
6	Nitro Spyder (5-112) Beskrivning: Nitro Slv	C-143				100:-	02005065	x	x

* Utgår vid slut

Nitro

Bild	Modell	Märkning	Ytter dia. (mm)	Inner dia. (mm)	Djup (mm)	Pris Exkl.	Cap + Logo	Cap	Logo
6	Nitro Spyder	C-284-1 Beskrivning: Nitro Slv	55	48,4	8 Dia. (mm): 60 plan	100:-	x	02005002	02006002
7	Nitro Spyder G.Blk/Pol (5-108)	VV-05 Beskrivning: Nitro Blk	62,2	56,5	15,6 Dia. (mm): 63 kvx	100:-	02005072	x	x
7	Nitro Spyder G.Blk/Pol (5-112)	C-143-MBK Beskrivning: Nitro Blk			62 kvx Dia. (mm):	100:-	02005069	02005068	02006044
7	Nitro Spyder G.Blk/Pol (5-120)	C-043 Blk Beskrivning: Nitro Blk	67	60	12 Dia. (mm): 62 kvx	100:-	02007073	02005015	02006044
7	Nitro Spyder G.Blk/Pol	C-284-1 Beskrivning: Nitro Blk	55	48,4	8 Dia. (mm): 60 plan	100:-	x	02005002	x
12	Nitro Throne FF (5-108)	XCVOL G.Blk Beskrivning: Nitro G.Blk			60 kvx Dia. (mm):	100:-	07005203	07005204	07006109
12	Nitro Throne FF	XC647VW G.Blk Beskrivning: Nitro G.Blk			60 kvx Dia. (mm):	100:-	07005206	07005207	07006107
11	Nitro Turismo FF (5-108)	C-154 Beskrivning: Nitro G.Gun			Dia. (mm):	100:-	02005084	02005083	02006052
11	Nitro Turismo FF (5-112 60° Kona)	C-137Gm Beskrivning: Nitro G.Gun			Dia. (mm):	100:-	02005086	02005085	02006049
11	Nitro Turismo FF (5-112 R14)	C-140Gm Beskrivning: Nitro G.Gun			Dia. (mm):	100:-	02005088	02005087	02006050
11	Nitro Turismo FF (5-114 Cb 70,5)	C-284-1 Beskrivning: Nitro G.Gun			Dia. (mm):	100:-	02005091	02005001	02006062
11	Nitro Turismo FF	C-C43Gm Beskrivning: Nitro G.Gun			Dia. (mm):	100:-	02005090	02005089	02006051
11	Nitro Turismo FF G.Gun/Pol (5-108)	C-154 Beskrivning: Nitro G.Gun			Dia. (mm):	100:-	02005084	02005083	02006048
11	Nitro Turismo FF G.Gun/Pol (5-112 60° Kona)	C-137Gm Beskrivning: Nitro G.Gun			Dia. (mm):	100:-	02005086	02005085	02006049
11	Nitro Turismo FF G.Gun/Pol (5-112 R14)	C-140Gm Beskrivning: Nitro G.Gun			Dia. (mm):	100:-	02005088	02005087	02006050
11	Nitro Turismo FF G.Gun/Pol	C-C43Gm Beskrivning: Nitro G.Gun			Dia. (mm):	100:-	02005090	02005089	02006051
4	Nitro Ultra	C398-MGM6 Beskrivning: Nitro Blk			65 kvx Dia. (mm):	100:-	07005117	07005114	07006034
6	Nitro Volcano (5-108)	XCVOL Beskrivning: Nitro Slv			60 kvx Dia. (mm):	100:-	07005165	07005014	07006076
6	Nitro Volcano (5-112 Radius Kona)	XC647VW Beskrivning: Nitro Slv			60 kvx Dia. (mm):	100:-	07005166	07005123	07006024
6	Nitro Volcano (5-112 60° Kona)	XC512-S-BW Beskrivning: Nitro Slv			56 kvx Dia. (mm):	100:-	07005167	07005174	07006077
6	Nitro Volcano (5-120)	XC512BW Beskrivning: Nitro Slv			65,5 kvx Dia. (mm):	100:-	07005168	07005173	07006078
10	Nitro Volcano G.Gun (5-108)	XCVOL-GM Beskrivning: Nitro Gm			60 kvx Dia. (mm):	100:-	07005169	07005175	07006079
10	Nitro Volcano G.Gun (5-112 Radius Kona)	XC647VW-GM Beskrivning: Nitro Gm			60 kvx Dia. (mm):	100:-	07005170	07005176	07006080
10	Nitro Volcano G.Gun (5-112 60° Kona)	XC512-S-BW Beskrivning: Nitro Gm			56 kvx Dia. (mm):	100:-	07005171	07005174	07006081
10	Nitro Volcano G.Gun (5-120)	XC512BW-GM Beskrivning: Nitro Gm			65,5 kvx Dia. (mm):	100:-	07005172	07005177	07006082

* Utgår vid slut

BM Wheels



Bild	Modell	Märkning	Ytter dia. (mm)	Inner dia. (mm)	Djup (mm)	Pris Exkl.	Cap + Logo	Cap	Logo
4	BM Amiata*	C-G96	65	60	9,4	100:-	x	07005053	07006014
		Beskrivning: BM Racing Stv			Dia. (mm): 62 kvx				
2	BM Bari*	PCW3B	55	50	8	100:-	09005054	09005003	09006017
		Beskrivning: BM Racing Stv			Dia. (mm): 55 kvx				
6	BM Capri Pcd 100	XCE-030-CH			9	100:-	07005110	07005005	07006062
		Beskrivning: BM Racing Stv			Dia. (mm): 56,5 kvx				
6	BM Capri Pcd >100	C-287-C	62,2	57	9	100:-	x	07005016	x
		Beskrivning: BM Racing Stv			Dia. (mm): 62 kvx				
2	BM Coach	PCW3B-60	62	56,8	10,4	100:-	09005065	09005038	09006053
		Beskrivning: BM Racing Stv			Dia. (mm): 65 kvx				
2	BM Cortina*	PCW3B	55	50	8,4	100:-	09005046	09005003	09006005
		Beskrivning: BM Racing Stv			Dia. (mm): 55 kvx				
9	BM Drive Pcd 100	C-030-GM6				100:-	07005139	x	x
		Beskrivning: BM Wheels GM6			Dia. (mm): 56,5 kvx				
9	BM Drive	C-287-GM6				100:-	07005137	x	x
		Beskrivning: BM Wheels GM6			Dia. (mm): 62 kvx				
9	BM Drive M.Gun Pcd 100	C-030-MB				100:-	07005107	x	x
		Beskrivning: BM Wheels M.Blk			Dia. (mm): 56,5 kvx				
9	BM Drive M.Gun	C-287-MB	62,2	57	9	100:-	07005116	07005106	07006065
		Beskrivning: BM Wheels M.Blk			Dia. (mm): 62 kvx				
10	BM Escape (5-108)	VV-05	62,2	56,5	15,6	100:-	02005012	x	x
		Beskrivning: BM Racing Stv			Dia. (mm): 63 kvx				
10	BM Escape (5-112/114)	C-284-1	55	48,4	7,8	100:-	02005050	02005002	x
		Beskrivning: BM Racing Stv			Dia. (mm): 60 plan				
1	BM Forno*	Red C-E37	60	54,5	14	100:-	x	x	07006056
		Black C-E37	60	54,5	14	100:-	x	07005036	07006056
		Chrome C-E37	60	54,5	14	100:-	x	x	07006056
		Beskrivning: BM Racing Stv			Dia. (mm): 50 plan				
3	BM Hawk Pcd 100*	PCW3B-60	55	50	10,4	100:-	09005046	09005003	x
		Beskrivning: BM Racing Stv			Dia. (mm): 55 kvx				
3	BM Hawk Pcd >100*	PCW3B-60	62	56,8	10,4	100:-	09005053	09005038	09006018
		Beskrivning: BM Racing Stv			Dia. (mm): 65 kvx				
8	BM Macho	PCW3B-60	62	56	10,5	100:-	09005032	09005038	09006031
		Beskrivning: BM Wheels Stv			Dia. (mm): 65 kvx				
9	BM Macho M.Blk	PCW3B-60 FB	62	56	10,5	100:-	09005034	09005025	09006032
		Beskrivning: BM Wheels Blk			Dia. (mm): 65 kvx				
9	BM Power	C-284-1	55	48,4	7,8	100:-	02005095	02005002	x
		Beskrivning: BM Wheels Stv			Dia. (mm): 60 plan				
8	BM Raven	C-287-C	62,2	57	9	100:-	07005115	07005016	x
		Beskrivning: BM Wheels Stv			Dia. (mm): 62 kvx				
9	BM Raven G.Blk	C-287-C MB	62,2	57	9	100:-	07005116	07005106	07006065
		Beskrivning: BM Wheels M.Blk			Dia. (mm): 62 kvx				

* Utgår vid slut

BM Wheels

Bild	Modell	Märkning	Ytter dia. (mm)	Inner dia. (mm)	Djup (mm)	Pris Exkl.	Cap + Logo	Cap	Logo
10	BM Sector (5-108)	VV-05 Beskrivning: BM Racing Slv	62,2	56,5	15,6 Dia. (mm): 63 kvx	100:-	02005012	x	x
8	BM Split	PCW 3B Beskrivning: BM Wheels Slv	55	50	8,4 Dia. (mm): 55 kvx	100:-	09005067	09005003	x
7	BM Shadow	C-287-MB Beskrivning: BM Racing M.Blk	62,2	57	9 Dia. (mm): 62 kvx	100:-	x	07005106	x
6	BM Tornado Pcd 100	XCE-030-CH Beskrivning: BM Racing Slv			9 Dia. (mm):	100:-	07005110	07005005	07006062
6	BM Tornado Pcd >100	C-287-C Beskrivning: BM Racing Slv	62,2	57	9 Dia. (mm): 62 kvx	100:-	x	07005016	x

* Utgår vid slut

Ballistic, Incubus & PCW



Bild	Modell	Märkning	Ytter dia. (mm)	Inner dia. (mm)	Djup (mm)	Pris Exkl.	Cap + Logo	Cap	Logo
6	Ballistic Anvil	WXORGB				480:-	09005018	09005019	09006037
					Dia. (mm): 65,3 kvx				
8	Ballistic Dakota	Cap OR-VD FB				480:-	09005008	x	x
					Dia. (mm):				
9	Ballistic Dakota Blk.Pol	CAP OR-VD GB				480:-	09005010	x	x
					Dia. (mm):				
10	Ballistic Guillotine	Cap OR-D				480:-	09005011	x	x
					Dia. (mm): 65,3 kvx				
10	Ballistic Guillotine 8-165/170	Cap OR-3				480:-	09005009	x	x
					Dia. (mm): 65,3 kvx				
7	Ballistic Morax	WXORFB				480:-	09005020	09005021	09006037
					Dia. (mm): 65,3 kvx				
6	Ballistic Ravage	WXORGB				480:-	09005018	09005019	09006037
					Dia. (mm): 65,3 kvx				
1	INC Hunter/Hunter II/Safari	PCW-4	66,3	60,5	17	100:-	09005075	x	x
2	INC Krawler/Passion 5-114-127*	CAP WX-02				360:-	x	09005088	09006044
	Beskrivning: Incubus Blk				Dia. (mm): 52,6 kvx				
2	INC Krawler/Passion 5-135/139*	CAP WX-03	138 total	93	61 hög	360:-	x	09005089	09006045
	Beskrivning: Incubus Blk				Dia. (mm): 65 kvx				
2	INC Krawler/Passion 6-135/139*	CAP WX-04				360:-	x	09005090	09006045
	Beskrivning: Incubus Blk				Dia. (mm): 65 kvx				
2	INC Krawler/Passion 8-165/170*	CAP WX-05	168 total	127	85 hög	360:-	x	09005091	09006046
	Beskrivning: Incubus Blk				Dia. (mm): 98 kvx				
3	INC Northstar 5-139*	CAP WX-08				360:-	x	x	09006041
	Beskrivning: Incubus Blk				Dia. (mm): 49 kvx				
3	INC Northstar 8-165-180*	CAP WX-11				360:-	x	09005084	x
	Beskrivning: Incubus Blk				Dia. (mm): 65 kvx				
3	INC Northstar 6-135/139*	CAP WX-09				360:-	x	09005085	09006041
	Beskrivning: Incubus Blk				Dia. (mm): 49 kvx				
3	INC Northstar 6-114/127*	CAP WX-13				360:-	x	09005086	09006042
	Beskrivning: Incubus Blk				Dia. (mm): 43 kvx				
5	Plastic Piece Flat Black+Rivets 17" Ballstic Morax					120:-	09005078		
5	Plastic Piece Flat Black+Rivets 18" Ballstic Morax					120:-	09005079		
5	Plastic Piece Flat Black+Rivets 20" Ballstic Morax					120:-	09005080		

* Utgår vid slut



Image

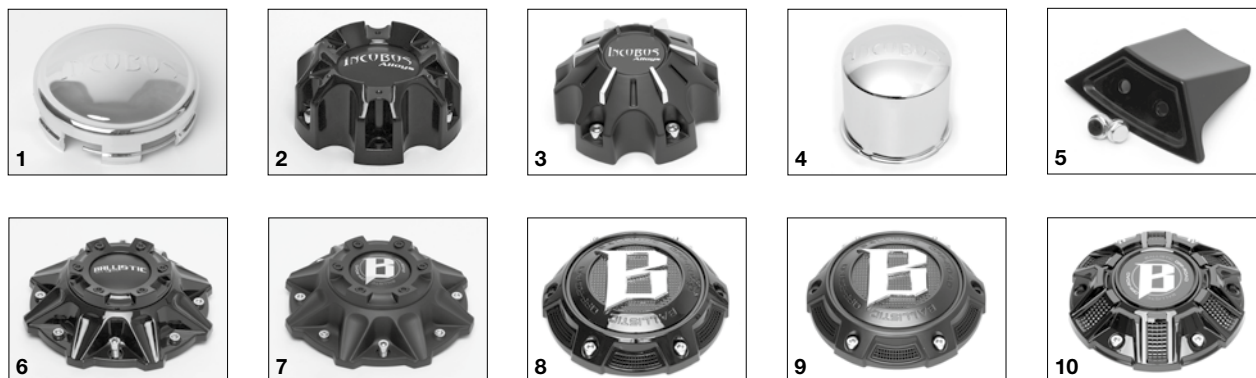

Bild	Modell	Märkning	Ytter dia. (mm)	Inner dia. (mm)	Djup (mm)	Pris Exkl.	Cap + Logo	Cap	Logo
1									
2									
3									
4									
5									
6									
7									
8	Image Atlas PCD <100	PCW3B Beskrivning: Image Slv	55	50	9 Dia. (mm): 55 kvx	100:-	09005006	09005003	09006022
8	Image Atlas PCD >100	PCW3B-60 Beskrivning: Image Slv	62	56	10,5 Dia. (mm): 65 kvx	100:-	09005007	09005038	09006023
8	Image Atlas (Et 62)	Mercy Polos Beskrivning: Image Slv			70 plan Dia. (mm): 70 plan	100:-	09005065	09005061	09006026
11	Image Atlas M.Gun PCD <100	PCW3B FSDG Beskrivning: Image Gun	54,8	50	8,4 Dia. (mm): 55 kvx	100:-	09005069	09005068	09006035
11	Image Atlas M.Gun PCD >100	PCW3B-60 FSDG Beskrivning: Image Gun	62	56	10,5 Dia. (mm): 65 kvx	100:-	09005036	09005070	09006034
11	Image Atlas M.Gun (Et 62)	Mercy Polos FSDG Beskrivning: Image Gun			70 plan Dia. (mm): 70 plan	100:-	09005029	09005028	09006033
11	Image Atom G.Gun (5-98/100)	XC648VW GM Beskrivning: Image G.Gun			50 kvx Dia. (mm): 50 kvx	100:-	07005179	07005178	07006096
11	Image AtomG.Gun (5-108/110)	XCVOL Beskrivning: Image G.Gun			60 kvx Dia. (mm): 60 kvx	100:-	07005180	07005175	07006095
11	Image Atom G.Gun	XC647VW Beskrivning: Image G.Gun			60 kvx Dia. (mm): 60 kvx	100:-	07005181	07005176	07006083
9	Image Atom Slv. (5-98/100)	XC648VW Beskrivning: Image Slv			50 kvx Dia. (mm): 50 kvx	100:-	07005164	07005161	07006044
9	Image Atom (5-108/110)	XCVOL Beskrivning: Image Slv			60 kvx Dia. (mm): 60 kvx	100:-	07005013	07005014	07006045
9	Image Atom Slv.	XC647VW Beskrivning: Image Slv			60 kvx Dia. (mm): 60 kvx	100:-	07005141	07005123	07006046
6	Image Arctis*	C126 Beskrivning: Image Slv	150 total		59,6 plan Dia. (mm): 59,6 plan	100:-	02005034	x	02006003
2	Image Avalon*	C-284-1 Beskrivning: Image Slv	55	48,4	7,8 Dia. (mm): 60 plan	100:-	02005001	02005002	02006003
3	Image Blade gamla*	SH004-CAP	150 total			160:-	x	09005045	09006006
3	Image Blade nya*	CAP SH004-2 Beskrivning: Image Slv	150 total		58 plan Dia. (mm): 58 plan	160:-	x	x	09006006
	Image Brio					100:-	08005001	08005003	07006046
7	Image Carrier PCD <100	PCW3B FB Beskrivning: Image Blk	54,8	50	8,4 Dia. (mm): 55 kvx	100:-	09005022	09005023	09006020
7	Image Carrier PCD >100	PCW3B-60 FB Beskrivning: Image Blk	62	56	10,5 Dia. (mm): 65 kvx	100:-	09005024	09005025	09006021
7	Image Carrier (Et 62)	Mercy Polos FB Beskrivning: Image Blk			70 plan Dia. (mm): 70 plan	100:-	09005064	09005062	09006025
8	Image Classic	PCW3B-60 Beskrivning: Image Slv	62	56	10,5 Dia. (mm): 65 kvx	100:-	09005007	09005038	09006023
7	Image Colt (5-100)	C-030-GB Beskrivning: Image G.Blk			56,5 kvx Dia. (mm): 56,5 kvx	100:-	07005030	07005031	07006106
7	Image Colt	C398C-G.Blk Beskrivning: Image G.Blk			65 kvx Dia. (mm): 65 kvx	100:-	07005184	07005158	07006102
7	Image Colt L.Gun (5-100)	C-030-LGM Beskrivning: Image L.Gun			56,5 kvx Dia. (mm): 56,5 kvx	100:-	07005091	07005092	07006112
	Image Colt L.Gun	C398C-L.Gun Beskrivning: Image L.Gun			65 kvx Dia. (mm): 65 kvx	100:-	07005142	07005143	07006111
7	Image Colt SUV	C398C-G.Blk Beskrivning: Image G.Blk			65 kvx Dia. (mm): 65 kvx	100:-	07005184	07005158	07006102
	Image Colt SUV L.Gun	C398C-L.Gun Beskrivning: Image L.Gun			65 kvx Dia. (mm): 65 kvx	100:-	07005142	07005143	07006111

Image

Bild	Modell	Märkning	Ytter dia. (mm)	Inner dia. (mm)	Djup (mm)	Pris Exkl.	Cap + Logo	Cap	Logo
11	Image Comet	XC648VW Gm Beskrivning: Image G.Gun			Dia. (mm): 50 kvx	100:-	07005179	07005178	07006096
7	Image Comet G.Blk/Pol	XC648VW G.Blk Beskrivning: Image G.Blk			Dia. (mm): 50 kvx	100:-	07005208	07005209	07006110
8	Image Comet Slv.	XC648VW Beskrivning: Image Slv			Dia. (mm): 50 kvx	100:-	07005164	07005161	07006044
4	Image Davos*	CAP-SH11 Beskrivning: Image Slv	155 total		Dia. (mm): 58 plan	160:-	x	09005051	09006006
8	Image Delta PCD <100	PCW3B Beskrivning: Image Slv	54,8	50	8,4 Dia. (mm): 55 kvx	100:-	09005006	09005003	09006022
8	Image Delta PCD >100	PCW3B-60 Beskrivning: Image Slv	62	56	10,5 Dia. (mm): 65 kvx	100:-	09005007	09005038	09006023
7	Image Delta M.Blk PCD <100	PCW3B FB Beskrivning: Image Slv	54,8	50	8,4 Dia. (mm): 55 kvx	100:-	09005022	09005023	09006020
7	Image Delta M.Blk PCD >100	PCW3B-60 FB Beskrivning: Image Slv	62	56	10,5 Dia. (mm): 65 kvx	100:-	09005024	09005025	09006021
8	Image Legend	PCW3B-60 Beskrivning: Image Gun	62	56	10,5 Dia. (mm): 65 kvx	100:-	09005036	09005070	09006034
1	Image Lugano*	PCW3B Beskrivning: Image Slv	54,8	50	8,4 Dia. (mm): 55 kvx	100:-	09005042	09005003	09006004
5	Image Mist hög*	PCW-3BB Beskrivning:	55	50,7	12 Dia. (mm): 45 kvx	100:-	x	09005044	x
9	Image Motion (5-100)	XC648VW Beskrivning: Image Slv			Dia. (mm): 50 kvx	100:-	07005164	07005161	07006044
9	Image Motion (5-108)	XCVOL Beskrivning: Image Slv			Dia. (mm): 60kvx	100:-	07005013	07005014	07006045
9	Image Motion	XC647VW Beskrivning: Image Slv			Dia. (mm): 60 kvx	100:-	07005141	07005123	07006046
11	Image Motion G.Gun (5-100)	XC648VW GM Beskrivning: Image G.Gun			Dia. (mm): 50 kvx	100:-	07005179	07005178	07006096
11	Image Motion G.Gun (5-108)	XCVOL Beskrivning: Image G.Gun			Dia. (mm): 60kvx	100:-	07005180	07005175	07006095
11	Image Motion G.Gun	XC647VW Beskrivning: Image G.Gun			Dia. (mm): 60 kvx	100:-	07005181	07005176	07006083
8	Image Palermo Pcd 100/108	XCE030CH Beskrivning: Image Slv			9 Dia. (mm):	100:-	07005118	07005005	07006066
8	Image Palermo >110	C-287-C Beskrivning: Image Slv	62,2	57	9 Dia. (mm): 62 kvx	100:-	07005119	07005016	07006067
10	Image Polar	PCW3B Beskrivning: Image Slv	54,8	50	8,4 Dia. (mm): 55 kvx	100:-	09005006	09005003	09006022
8	Image Rebel (4-100)	PCW3B Beskrivning: Image Slv			Dia. (mm): 55 kvx	100:-	09005006	09005003	09006022
8	Image Rebel (4-115)	PCW3B-60 Beskrivning: Image Slv			Dia. (mm): 65 kvx	100:-	09005007	09005038	09006023
7	Image Rebel M.Blk (4-100)	PCW3B FB Beskrivning: Image Blk			Dia. (mm): 55 kvx	100:-	09005022	09005023	09006020
7	Image Rebel M.Blk (4-115)	PCW3B-60 FB Beskrivning: Image Blk			Dia. (mm): 65 kvx	100:-	09005024	09005025	09006021
9	Image Ride	XC566VW Beskrivning: Image Slv			Dia. (mm): 60 kvx	100:-	07005019	07005127	07006046
	Image Ride Blk/Pol	XC566VW-GB Beskrivning: Image G.Blk			Dia. (mm): 60 kvx	100:-	07005021	07005128	07006084
9	Image Ride HL	XCB87 Beskrivning: Image Slv			Dia. (mm): 62 kvx	100:-	07005022	07005002	07006067
12	Image Ride HL M.Gun	XCB87-GM Beskrivning: Image G.Gun			Dia. (mm): 62 kvx	100:-	07005025	07005027	07006007
	Image Ride HL Blk/Pol	XCB87-GB Beskrivning: Image G.Blk			Dia. (mm): 62 kvx	100:-	07005025	07005027	07006007
	Image Rock	PCW3B DG Beskrivning: Image Gun	54,8	50	8,4 Dia. (mm): 55 kvx	100:-	09005014	09005013	09006035
	Image Rock 6-114	Beskrivning: Image Gun			Dia. (mm):	100:-	09005016	x	x
	Image Rock G.Blk	PCW3B DG Beskrivning: Image Gun	54,8	50	8,4 Dia. (mm): 55 kvx	100:-	09005127	09005126	09006016

Image

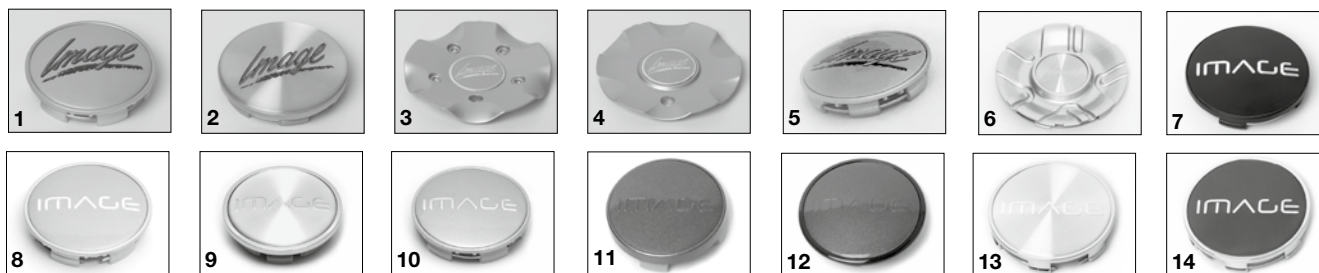
Bild	Modell	Märkning	Ytter dia. (mm)	Inner dia. (mm)	Djup (mm)	Pris Exkl.	Cap + Logo	Cap	Logo
	Image Rock 6-114 G.Blk	M-2P Beskrivning: Image Gun				100:-	09005026	x	x
	Image Rough	PMC 641 Beskrivning: Image M.Blk					07005011	07005010	07006113
	Image Solid	PCW3B DG Beskrivning: Image Gun	54,8	50	8,4	100:-	09005014	09005013	09006035
	Image Solid Gun/Pol	PCW3B DG Beskrivning: Image Gun	54,8	50	8,4	100:-	09005014	09005013	09006035
	Image Star FF G.Blk/Pol	C073A-G.Blk Beskrivning: Image G.Blk				100:-	07005090	07005156	07006102
	Image Star FF L.Gun	C073A-L.Gun Beskrivning: Image L.Gun				100:-	07005087	07005086	07006011
	Image Star FF Slv	C073A Beskrivning: Image Slv				100:-	07005088	07005081	07006100
8	Image Stella	Image Slv Beskrivning: Image Slv				100:-	09005123	x	x
7	Image Stella Blk	Image Blk Beskrivning: Image Blk				100:-	09005125	x	x
13	Image Strong <120	C398C Beskrivning: Image Slv				100:-	07005182	07005034	07006100
13	Image Strong >130	TR36-C Beskrivning: Image Slv				100:-	07005186	07005185	07006103
13	Image Strong G.Blk <120	C398C-G.Blk Beskrivning: Image G.Blk				100:-	07005184	07005158	07006102
13	Image Strong G.Blk >130	TR36-C-G.Blk Beskrivning: Image G.Blk				100:-	07005188	07005185	07006105
14	Image Strong M.Gun <120	C398-MGM6 Beskrivning: Image MGM				100:-	07005183	07005114	07006101
14	Image Strong M.Gun >130	TR36-C Beskrivning: Image MGM				100:-	07005187	07005185	07006104
	Image Thor					100:-	x	08005002	
1	Image Torino PCD>100	XCF56-C Beskrivning: Image Slv	54,8	50	7,8	100:-	07005111	07005068	07006063
1	Image Torino PCD 100	PCF86-C Beskrivning: Image Slv	56,5	51	9	100:-	07005112	07005069	07006063
2	Image Twist	C-284-1 Beskrivning: Image Slv	55	48,4	7,8	100:-	02005001	02005002	02006003
11	Image Vector (5-098/108)	XC647VW2 Beskrivning: Image G.Gun				100:-	07005179	07005178	07006096
11	Image Vector	XC647VW Beskrivning: Image G.Gun				100:-	07005181	07005176	07006083
	Image Vector G.Blk (5-108)	XC648VW G.Blk Beskrivning: Image G.Blk				100:-	07005208	07005209	07006110
	Image Vector G.Blk/Pol	XC647VW G.Blk Beskrivning: Image G.Blk				100:-	07005210	07005207	07006084
9	Image Vector Slv (5-108)	XC647VW2 Beskrivning: Image Slv				100:-	07005164	07005161	07006044
9	Image Vector Slv	XC647VW Beskrivning: Image Slv				100:-	07005141	07005123	07006046
8	Image Vega D.Slv (5-100)	PCW3B Beskrivning: Image Gun	62	56	10,5	100:-	09005014	09005013	09006035
8	Image Vega D.Slv	PCW3B-60 FSDG Beskrivning: Image Gun	62	56	10,5	100:-	09005036	09005070	09006034
	Image Vega G.Blk (5-100)	PCW3B B Beskrivning: Image G.Blk	62	56	10,5	100:-	09005127	09005126	09006016
	Image Vega G.Blk	PCW3B-60 B Beskrivning: Image G.Blk	62	56	10,5	100:-	07005129	07005130	09006055
	Image Vega M.Gun (5-100)	PCW3B Beskrivning: Image Gun	62	56	10,5	100:-	09005128	09005068	09006035
	Image Vega M.Gun	PCW3B-60 FSDG Beskrivning: Image Gun	62	56	10,5	100:-	09005005	09005030	09006034
1	Image Wind*	PCW3B Beskrivning: Image Slv	54,8	50	8,4	100:-	09005042	09005003	09006004

* Utgår vid slut

Breyton / TSW / MSW



Bild	Modell	Märkning	Ytter dia. (mm)	Inner dia. (mm)	Djup (mm)	Pris Exkl.	Cap+Logo
1	Breyton GTR/GTSR/LS Silv	C-G96	65	60	9,4	250:-	06005007
	Beskrivning:				Dia. (mm): 62 kvx		
2	Breyton GTR/GTSR/LS Blk	C-G96	65	60	9,4	250:-	06005008
	Beskrivning:				Dia. (mm): 62 kvx		
3	Breyton GTS/GTSR Gun	C-G96	65	60	9,4	250:-	06005009
	Beskrivning:				Dia. (mm): 62 kvx		
1	Breyton Race GTP Silv	PC997	65	59,8	10	250:-	06005010
	Beskrivning:				Dia. (mm): 65 plan		
2	Breyton GTP Blk	PC997	65	59,8	10	250:-	06005011
	Beskrivning:				Dia. (mm): 65 plan		
3	Breyton GTP Gun	PC997	65	59,8	10	250:-	06005012
	Beskrivning:				Dia. (mm): 65 plan		
1	Breyton Race GTS Silv	C-G96	65	60	9,4	250:-	06005013
	Beskrivning:				Dia. (mm): 62 kvx		
6	TSW USA 60	C-F80	60	55,2	7,8	200:-	04005103
	Beskrivning:				Dia. (mm): 70 plan		
7	Beyern	C-C43	66,2	62	12	200:-	04005101
	Beskrivning:				Dia. (mm): 57 plan		
8	Mandrus	C-E71	69	65,4	17	200:-	04005102
	Beskrivning:				Dia. (mm): 63,5 kvx		
9	Victor Equipment	C-E76	60	55	14,3	200:-	04005114
	Beskrivning:				Dia. (mm):		
10	Breyton GTS-AV M.Black / 5-112			70		200:-	06005014
	Beskrivning:				Dia. (mm):		
11	Breyton GTS-AV M. Gun / 5-112			70		200:-	06005015
	Beskrivning:				Dia. (mm):		
12	Breyton GTS-AV Silver / 5-112			70		200:-	06005016
	Beskrivning:				Dia. (mm):		
10	Breyton GTS-AV M.Black / 5-100			60		200:-	06005017
	Beskrivning:				Dia. (mm):		
11	Breyton GTS-AV M. Gun / 5-100			60		200:-	06005018
	Beskrivning:				Dia. (mm):		
12	Breyton GTS-AV Silver / 5-100			60		200:-	06005019
	Beskrivning:				Dia. (mm):		

För Cap och Logo till OZ och MSW, fråga oss!

* Utgår vid slut

ATS



Bild	Modell	Märkning	Ytter dia. (mm)	Inner dia. (mm)	Djup (mm)	Pris Exkl.	Cap+Logo
1	ATS Antares 6,0x15	N23				200:-	02005109
	Beskrivning:				Dia. (mm):		
1	ATS Antares VW	N50				200:-	02005110
	Beskrivning:				Dia. (mm):		
1	ATS Antares Audi	N55				200:-	02005111
	Beskrivning:				Dia. (mm):		
2	ATS Antares G.Bik 6,0x15	N23				200:-	02005106
	Beskrivning:				Dia. (mm):		
2	ATS Antares G.Bik VW	N50				200:-	02005107
	Beskrivning:				Dia. (mm):		
2	ATS Antares G.Bik Audi	N55				200:-	02005108
	Beskrivning:				Dia. (mm):		
3	ATS Evolution 5-112	N54				200:-	02005104
	Beskrivning:				Dia. (mm):		
3	ATS Evolution 5-112	N37				200:-	02005105
	Beskrivning:				Dia. (mm):		
4	ATS Evolution G.Grey 5-112	N54				200:-	02005102
	Beskrivning:				Dia. (mm):		
4	ATS Evolution G.Grey 5-120	N37				200:-	02005103
	Beskrivning:				Dia. (mm):		
5	ATS Mizar	N12				200:-	02005101
	Beskrivning:				Dia. (mm):		
6	ATS Mizar G.Bik	N12				200:-	02005100
	Beskrivning:				Dia. (mm):		

4X4

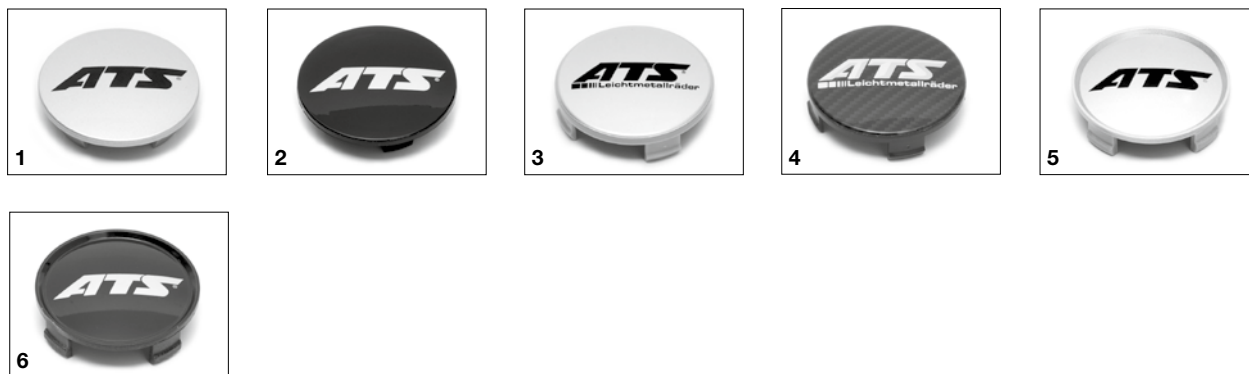

Bild	Artikelnr	Modell	Ytter dia. (mm)	Höjd (mm)	Material	Pris Exkl.
4	03005003*	Cap Stängd	84	85		100:-
2	03005022*	Cap Öppen	108	70		100:-
2	03005009*	Cap Öppen	108	112	Rostfri	100:-
1	03005014*	Cap Öppen	130	110	Rostfri	120:-
3	03005020*	Cap Öppen	108	70	Snap-on inkl. lock	120:-

* Utgår vid slut



Bild	Art.nr	Benämning	PCD	CB Fälg (mm)	CB Nav (mm)	Pris/st exkl.
1	050090041	Universalspacer 3 mm	4/5 Universal		78	68:-
1	050090051	Universalspacer 5 mm	4/5 Universal		75	88:-
1	050090031	Universalspacer 10 mm	4/5 Universal		75	112:-
	05009097	Universalspacer 6 mm	6-139,7		110	350:-
	05009094	Universalspacer 12 mm	6-139,7		110	400:-
5	05009032	Spacer 5 mm	4/5-100		54,1	276:-
5	05009033	Spacer 5 mm	4/5-100		57,1	276:-
5	05009034	Spacer 5 mm	4/5-108		63,3	276:-
5	05009035	Spacer 5 mm	4/5-108		65,1	276:-
5	05009036	Spacer 5 mm	5-100/112		57,1	276:-
5	05009037	Spacer 5 mm	4/5-114,3		67,1	276:-
		Audi/Seat/Skoda/VW				
9	05009015	Spacer 8 mm	4/5-100	73,1	57,1	500:-
8	05009044	Spacer 15 mm	5-112	57,1	57,1	600:-
8	05009045	Spacer 20 mm	5-112	57,1	57,1	600:-
8	05009046	Spacer 25 mm	5-112	57,1	57,1	600:-
		Audi/MB/Seat/Skoda/VW				
10	05009024	Spacer 8 mm	5-100/112	72,2	66,6	500:-
10	05009025	Spacer 8 mm	5-100/112	73,1	66,6	500:-
5	05009043	Spacer 10 mm	5-112		66,6	500:-
10	05009031	Spacer 15 mm	5-100/112	72,2	66,6	500:-
10	05009030	Spacer 15 mm	5-100/112	73,1	66,6	500:-
		(Vänligen beställ c-ring 666571 till Audi/VW)				
		Audi/MB				
8	05009047	Spacer 20 mm	5-112	66,5	66,5	600:-
		BMW				
8	05009028	Spacer 5 mm	5-120	74,1	72,5	500:-
5	05009038	Spacer 5 mm	5-120	72,5	72,5	500:-
5	05009039	Spacer 5 mm	5-120	74,1	74,1	500:-
8	05009026	Spacer 10 mm	5-120	74,1	72,5	500:-
5	05009058	Spacer 10 mm	5-120	72,5	72,5	500:-
8	05009029	Spacer 15 mm	5-120	74,1	72,5	600:-
8	05009060	Spacer 15 mm	5-120	72,5	72,5	600:-
8	05009063	Spacer 15 mm	5-120	72,5	74,1	600:-
8	05009048	Spacer 18 mm	5-120	72,5	72,5	600:-
8	05009042	Spacer 20 mm	5-120	72,5	72,5	600:-
8	05009019	Spacer 20 mm	5-120	72,5	74,1	600:-
8	05009061	Spacer 20 mm	5-120	74,1	74,1	600:-
8	05009064	Spacer 20 mm	5-120	74,1	72,5	600:-
		(t.ex. 3-seriens fälgar kan monteras på en 5-serie)				
		Breyton Spacer. Säljes endast parvis, priset avser 2 st spacer.				
5	06009001	Breyton Spacer 5 mm	5-120	72,5	72,5	1300:-
5	06009002	Breyton Spacer 5 mm	5-120	74,1	74,1	1300:-
8	06009006	Breyton Spacer 10 mm	5-120	74,1	74,1	1600:-
8	06009008	Breyton Spacer 10 mm	5-120	72,5	74,1	1600:-
8	06009011	Breyton Spacer 15 mm	5-120	74,1	72,5	1800:-
8	06009012	Breyton Spacer 15 mm	5-120	72,5	74,1	1800:-
8	06009016	Breyton Spacer 20 mm	5-120	72,5	74,1	1900:-
8	06009021	Breyton Spacer 11 mm	5-112	66,56	66,56	1600:-
8	06009022	Breyton Spacer 15 mm	5-112	66,56	66,56	1800:-
8	06009023	Breyton Spacer 20 mm	5-112	66,56	66,56	1900:-
8	06009024	Breyton Spacer 10 mm	5-112	66,56	57,1	1600:-
	06009025	Breyton Spacer 15 mm	5-112	66,56	57,1	1800:-
	06009026	Breyton Spacer 20 mm	5-112	66,56	57,1	1900:-
		Fiat/Renault				
9	05009096	Spacer 8 mm	5-118	73,1	71,1	500:-
		Peugeot/Saab/Volvo				
9	05009016	Spacer 5 mm	4/5-108	73,1	65,1	500:-
9	05009018	Spacer 8 mm	4/5-108	73,1	65,1	500:-
9	05009023	Spacer 15 mm	4/5-108	72,2	65,1	500:-
9	05009017	Spacer 20 mm	4/5-108	73,1	65,1	600:-
		Porsche/Vw				
5	05009051	Spacer 7 mm	5-130	71,6	71,6	500:-
9	05009095	Spacer 8 mm	5-120	73,1	65,1	500:-
		Saab/Peugeot				
9	05009049	Spacer 20 mm	4/5-108	65,1	65,1	600:-
8	05009050	Spacer 20 mm	5-110	65,1	65,1	600:-
		Nissan				
10	05009093	Spacer 6 mm	6-114,3	66,1	83,7	500:-
		Volvo				
7	05009027	Spacer 25 mm	5-108	65,1	65,1	1040:-
5	05009041	Spacer 10 mm	5-108		65,1	500:-

CB kommer av CenterBore och anger fälgens centrumhål i mm

* = Utgår vid slut.







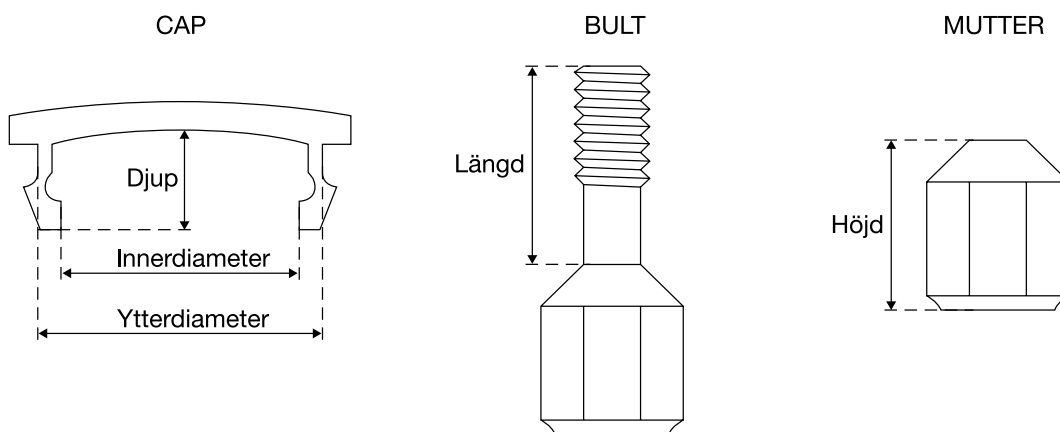

Bild	Art.nr	Gänga	Längd/ Höjd	Kona	Skalle	Övrigt	Pris Exkl	Bild	Art.nr	Gänga	Längd/ Höjd	Kona	Skalle	Övrigt	Pris Exkl
Mutter								Mutter							
1	05007007	M18x1,50	10	planbricka	32	Stängd	340:-	4	05007016	14x1,50	15	Plan	19	Öppen	48:-
	05007000	M20x1,50	10	planbricka	32	Stängd	340:-	5	05007017	16x1,50	17	Plan	22	Öppen	48:-
	05007001	22x1,50	39	planbricka	32	Öppen	188:-	6	05007018	18x1,50	18	Plan	24	Öppen	48:-
	05007003	7/8" UNF	39	planbricka	32	Öppen	188:-		05007019	20x1,50	20	Plan	27	Öppen	48:-
	05007005	7/8" BSF	39	planbricka	32	Öppen	188:-		05007020	22x1,50	22	Plan	30	Öppen	48:-
2	05007008	M18x1,50	27	planbricka		Stängd	380:-	7	05007021	14x1,50	20	R14	19	Öppen	48:-
	05007009	M20x1,50	27	planbricka		Stängd	380:-	8	05007022	16x1,50	26	R16	24	Öppen	48:-
	05007002	22x1,5	61	planbricka	32	Öppen	220:-	9	05007023	18x1,50	25	R16	24	Öppen	48:-
	05007004	7/8" UNF	61	planbricka	32	Öppen	220:-		05007024	20x1,50	27	R18	27	Öppen	48:-
	05007006	7/8" BSF	61	planbricka	32	Öppen	220:-		05007025	22x1,50	30	R18	30	Öppen	48:-
3	05007010	18x1,50	25	planbricka	27	Öppen	72:-		05007100	Xlite Apply/Remover Plier					200:-
	05007011	20x1,50	27	planbricka	30	Öppen	72:-	12	050079104	Lose Nut Indicator 32mm Yellow					24:-
	05007012	22x1,50	27	planbricka	32	Öppen	72:-		050079105	Lose Nut Indicator 33mm Yellow					24:-
	05007013	22x1,50	33	planbricka	31	Öppen	72:-								
	05007014	7/8" BSF	30	planbricka	33	Öppen	72:-		050079100	Flange wear guide					100:-
	05007015	7/8" UNF	30	planbricka	33	Öppen	72:-								
10	05007101	Wheel nut cover (Plastic)	32/33 mm				72:-								
	05007102	Wheel nut cover Chromed	32 mm				58:-								
	05007103	Wheel nut cover Chromed	33 mm				58:-								
	05007104	Wheel nut cover Stainless Steel	32 mm				58:-								
	05007105	Wheel nut cover Stainless Steel	33 mm				58:-								
11	05007901	Ventil Xlite TR543C					188:-								
	05007902	Ventil Xlite 70MS/TM1670					188:-								
	05007903	Ventil Xlite TR542C					188:-								

SÅ HÄR MÄTER VI:











Bilmärke/bilmodell	Ersätter OEM art.nr.	Gänga	Gänglängd/ totallängd (mm)	Kona	Skalle	Kvalitet/ material	Passar fälgtyp	Art.nr.	Pris Exkl
ALFA ROMEO									
 147, 156, 166, GT, MITO	132 304 25	12x1,25	22/48,5	Kona 60°	17	8.8 Dacromet	Stål och aluminium	05002516	48:-
 159 09.05-, Brera 01.06-, Spider 08.06-	606 974 42 606 941 02	14x1,50	25/51	Kona 60°	17	10.9 Geomet	Stål och aluminium	05002826	48:-
AUDI									
 TT, A2, A3, A4, A6, A8, 100, 200, V8	8D0 601 139 D	14x1,50	27/47,5	Radius R13	17	10.9 White Zincplated	Stål och aluminium	05002828	48:-
 A6 (V8) Quattro, A8 (V8) Quattro, TT Quattro: S6, S8 A5 (B8, B9), S5 (B8, B9), RS5 A6 (4F, 4G, F2), S6, RS6 A7 (4G, F2), TT (8N, 8J, 8S)	4D0 601 139 A	14x1,50	27/51	Radius R13	17	8.8 White Zincplated 2 pcs	Aluminium	05002829	48:-
 Q3 (8U, F3), Q5 (8R, FY) Q7 (4M), Q8 (4M)	8R0 601 295	14x1,50	30/59,5	Radius R14	17	10.9 Delta- protekt KL100 2 pcs	Stål och aluminium	05002846	84:-
 Audi Q7 12.05-	7L0 601 139 A	14x1,50	37/67	Radius R14	19	10.9 White Zincplated	Aluminium	05002837	84:-
BMW									
 1-serie E82, E87, E88, 3-serie E90, E91, E92, E93, 5-serie E60, E61, 6-serie E63, E64, 7-serie E32, E38, Z3 E85, Z4 E89	36 13 1 126 191 36 13 6 781 150	12x1,50	26/51	Kona 60°	17	10.9 Black Zincplated	Stål och aluminium	05002622	48:-







Bilmärke/bilmodell	Ersätter OEM art.nr.	Gänga	Gänglängd/ totallängd (mm)	Kona	Skalle	Kvalitet/ material	Passar fälgtyp	Art.nr.	Pris Exkl
BMW									
 BMW 1-serie F20,F21 2-serie F22,F23,F45,F46 3-serie F30,F31,F34,F35 / X F25 4-serie F32,F33,F36 / X F26 5-serie F10,F11,F18,F07 / X E70,F15,F85 6-serie F06,F12,F13 / X E71,E72,F16 7-serie F01,F02,F03,F04,G11,G12	36 13 6781 151	14x1,25	27/48	Kona 60°	17	8.8 Black Zincplated	Aluminium	05002923	48:-
 i3 19-, i8 19- X5 (G05), X6 (G06), X7 (G07) 7-serie (G11, G12) 05.19-	36 13 6 795 153	14x1,25	28/54	Kona 60°	17	10.9 Corrolube	Aluminium	05002928	84:-
CITROËN									
 Berlingo 09.96-04.08, Berlingo 05.08-05.18, C2, C3, C4, C5, C6, C4 Picasso, Cactus DS3, DS4, DS5, DS7 Jumpy 01.06-05.16	5405.67	12x1,25	17/57	Bricka	17	10.9 Geomet	Aluminium	05002517	48:-
 C4 Grand Picasso,Cactus 11.06-08.13, C5	5405.72	12x1,25	26/49	Kona 60°	17	10.9 Geomet	Stål	05002524	48:-
 C2, C3, C4	5405.55	12x1,25	26/52	Kona 60°	19	10.9 White Zincplated	Stål och aluminium	05002511	48:-
 Berlingo, C2, C3, C4, Saxo, Xsara	5405.66	12x1,25	26/47	Kona 60°	17	10.9 Geomet	Stål	05002526	48:-
 C1 07.05-06.14 (PM,PN) C1 07.14- (580W)	5405.80 5405.85	12x1,50 12x1,50	35/59,5	Bricka	17	10.9 Dacromet	Aluminium	05002618	48:-







Bilmärke/bilmodell	Ersätter OEM art.nr.	Gänga	Gänglängd/ total längd (mm)	Kona	Skalle	Kvalitet/ material	Passar fälgtyp	Art.nr.	Pris Exkl
CITROËN									
 Aircross (B) C-Crosser (V)	5405.82	12x1,50		Bricka	21	8 Chromeplated	Aluminium	05001697	48:-
 Jumper (lilla chassit) 03.94-03.02	5405.75	14x1,50	28/53	Kona 60°	24	10.9 Geomet	Stål	05002824	48:-
 C8 09.02-11.10	5405.69	14x1,50	26/56,5	Kona 60°	17	10.9 Geomet	Aluminium	05002819	48:-
 C8 09.02-11.10, Jumpy (lilla chassit) 04.02-05.06	5405.68	14x1,50	25/56,5	Kona 60°	17	10.9 Geomet	Stål	05002823	48:-
 Jumper (stora chassit) 06.06-08.14	5405.76	16x1,50	31/57	Kona 60°	24	10.9 Geomet	Stål	05003024	48:-
 Jumper (lilla chassit) 06.06-08.14	5405.78 5405.88	14x1,50	27/62	Kona 60°	21	10.9 Geomet	Stål och aluminium (endast 15" 5-118)	05002825	48:-
 Jumper (stora chassit) 06.06-08.14	5405.79	16x1,50	29/64	Kona 60°	21	10.9 Geomet	Stål och aluminium (endast 16" 5-130)	05003029	48:-
FIAT									
 Bravo 04.07-, Panda II, Punto II, 500 01.07-	13.230.425	12x1,25	22/48,5	Kona 60°	17	8.8 Dacromet	Stål och aluminium	05002516	48:-
 Grande Punto 10.05-, Croma 06.05-, Sedici 04.06-	51.732.885	12x1,50	22/47,5	Kona 60°	17	10.9 White Zincplated	Stål och aluminium	05002617	48:-

Bilmärke/bilmodell	Ersätter OEM art.nr.	Gänga	Gänglängd/ totallängd (mm)	Kona	Skalle	Kvalitet/ material	Passar fälgtyp	Art.nr.	Pris Exkl
FIAT									
 DUCATO (lilla chassit) 03.94-03.02	1.345.713.080	14x1,50	28/53	Kona 60°	24	10.9 Geomet	Stål	05002824	48:-
 DUCATO (stora chassit) 04.02-05.06	1.345.714.080	16x1,50	31/57	Kona 60°	24	10.9 Geomet	Stål	05003024	48:-
 DUCATO (lilla chassit) 06.06-08.14	1.363.349.080 1.351.202.080	14x1,50	27/62	Kona 60°	21	10.9 Geomet	Stål och aluminium (endast 15" 5-118)	05002825	48:-
 DUCATO (stora chassit) 06.06-08.14	1.351.203.080	16x1,50	29/64	Kona 60°	21	10.9 Geomet	Stål och aluminium (endast 16" 5-130)	05003029	48:-
 Scudo 10.06-04.16	9.644.576.680	12x1,25	17/57	Bricka	17	10.9 Geomet	Aluminium	05002517	48:-
 Fullback (KT0T)	MR455707	12x1,50		Bricka	21	8 Chromeplated	Aluminium	05001697	48:-
FORD									
 KA 01.09-	1 559 373	12x1,25	22/48,5	Kona 60°	17	8.8 Dacromet	Stål och aluminium	05002516	48:-
 Ka 11.96-12.08, Fiesta 04.02-09.08 Fusion 10.02-06.12, Focus 12.04-02.11, Mondeo 06.07-09.14	6.040.307 1.007.487	12x1,50		Kona 60°	19	8 Phosphated	Stål	05001663	48:-







Bilmärke/bilmodell	Ersätter OEM art.nr.	Gänga	Gänglängd/ totallängd (mm)	Kona	Skalle	Kvalitet/ material	Passar fälgtyp	Art.nr.	Pris Exkl
FORD									
 Fiesta , Focus, C Max, Mondeo, Cougar, KA Fiesta 10.08-, Focus 05.07- C-Max 10.10-, Kuga 06.08- Fiesta, Focus, C Max, Mondeo, Cougar, KA	6.111.766 1.454.051 6.652.292	12x1,50		Kona 60°	19	10 Stainless steel	Aluminium (öppen)	05001698	48:-
 Fiesta 10.08-, Focus 05.07- C-Max 10.10-, Kuga 06.08-	1 454 053	12x1,50		Kona 60°	19	10 Stainless steel	Aluminium (öppen)	05001698	48:-
 Galaxy 09.95-04.01	7.201.016	14x1,50	34/66	Radius R14	19	10.9 Phosphated	Stål och aluminium	05002898	48:-
 Galaxy 05.01-06.06	1.126.877	14x1,50	34/62	Radius R14	19	10.9 Dacromet	Stål och aluminium	05002834	48:-
 S-Max 06.06- Galaxy 07.06-	1.377.748	14x1,50		Kona 60°	21	10 White Zincplated	Stål	05001878	48:-
 S-Max 06.06- Galaxy 07.06-	1.428.138 1.377.747	14x1,50		Kona 60°	21	10 White Zincplated	Stål och aluminium	05001877	48:-
 Transit 01.13- (single wheels only)	ACPA-1012-KXA	14x1,50		Kona 60°	21	10.9 White Zincplated 2Pcs	Aluminium	05001873-2	84:-
 Ford Transit 2000-2006 /2006-2011	1.576.434	14x2	25	Plan	21	10 Cromax + Magni	Stål	05001973	48:-







Bilmärke/bilmodell	Ersätter OEM art.nr.	Gänga	Gänglängd/ total längd (mm)	Kona	Skalle	Kvalitet/ material	Passar fälgtyp	Art.nr.	Pris Exkl
FORD									
 Ford Transit 2013-	1.811.812	14x1,50	25	Plan	21	10 Zinclad + Magni	Stål	05001876	48:-
HYUNDAI									
 I10 (IA, PA), I20 (PB, GB) I30 (FD), I40 (VF), ix20 (JC) ix35 (EL), Kona (OS) Tucson (JM, TL)	52950-14140 52950-M1000 52951-31330	12x1,50		Kona 60°	21	8 Chromeplated	Aluminium	05001675	48:-
 I10 (IA, PA), I20 (PB, GB) I30 (FD), ix35 (EL) Kona (OS), Tucson (JM, TL)	52950-3Y000 52950-17000 52951-11210	12x1,05		Kona 60°	21	8 Chromeplated	Stål	05001676	48:-
JAGUAR									
 E-Pace (DF) F-Pace (DC)	T4A2670	14x1,50		Kona 60°	21	10 White Zincplated	Aluminium Stainless Steel	05001877	48:-
KIA									
 Carens (FC), Carnival Ceed (CD), Niro (DE) Picanto (TA), Rio (DE, UB) Sorento (XM, UM) Soul (AM, PS), Venga Sportage (QLE), Stonic (YB)	52950-14140 52950-M1000 52950-1G000 52950-H1000	12x1,50		Kona 60°	21	8 Chromeplated	Aluminium	05001675	48:-
 Carens (FC), Carnival Ceed (CD), Niro (DE) Picanto (TA), Rio (DE, UB) Sorento (XM, UM) Soul (AM, PS), Venga Sportage (QLE), Stonic (YB)	52950-3Y000 52950-17000 52951-11210	12x1,05		Kona 60°	21	8 Chromeplated	Stål	05001676	48:-

Bilmärke/bilmodell	Ersätter OEM art.nr.	Gänga	Gänglängd/ total längd (mm)	Kona	Skalle	Kvalitet/ material	Passar fälgtyp	Art.nr.	Pris Exkl
LANCIA									
 Delta 08.08-, Kappa, Lybra, Musa 09.04-	13.230.425	12x1,25	22/48,5	Kona 60°	17	8.8 Dacromet	Stål	05002516	48:-
LAND ROVER									
 Defender -2006, Discovery I, Range Rover	ANR2763MMM	16x1,5		Bricka	27	8 Zincplated	Aluminium	05001490	84:-
 Defender 2007-	RRD500560	14x1,5		Bricka	27	8 Zincplated	Aluminium	05001891	84:-
 Discovery III & IV, Range Rover Sport (LS) (LW) Range Rover Vogue (LM) (LG)	RRD500590	14x1,5		Bricka	22	8 Zincplated	Aluminium	05001892	84:-
 Range Rover Evoque (LV) Frelander (LF) Disc. sport (LC)	LR001381	14x1,5		Kona 60°	21	10 Zincplated Stainless steel	Aluminium	05001877	48:-
LEXUS									
 Lexus ES 07.01-, GS 08.97- IS 01.99-, LS430, RX 02.03-	90942-01053	12x1,50		Bricka	21	8 Chromeplated	Aluminium	05001697	48:-
 Lexus ES300, GS 08.96- GX470, IS 07.01-, LS 01.00- RX 01.98-, SC 01.97-	90942-01858	12x1,50		Bricka	21	8 Chromeplated	Aluminium	05001696	48:-
 Lexus LX470-570	90942-01103	14x1,50		Bricka	22	8 Chromeplated	Aluminium	05001897	84:-

Bilmärke/bilmodell	Ersätter OEM art.nr.	Gänga	Gänglängd/ total längd (mm)	Kona	Skalle	Kvalitet/ material	Passar fälgtyp	Art.nr.	Pris Exkl
MAZDA									
 3, 5, 6, 323, 626, MX3, MX5, MX6, Premacy	0603 26 161	12x1,50		Kona 60°	21	8 Yellow Zincplated	Stål	05001662	48:-
 CX-5, CX-7, CX-9 2 (DE, DJ, DL) 3 (BK, BL), 5 (CR, CW) 6 (GG, GH, GJ) MX-5 (NA, NB, NC, ND)	0B002-37-160 B002-37-160 KA78-37-160 UH72-37-160 UR58-37-160	12x1,50		Kona 60°	21	8 Chromeplated	Aluminium	05001675	48:-
 CX-5, CX-7, CX-9 2 (DE, DJ, DL) 3 (BK, BL), 5 (CR, CW) 6 (GG, GH, GJ) MX-5 (NA, NB, NC, ND)	0603-26-161A 0603-26-161 0603-26-161X	12x1,50		Kona 60°	21	8 Chromeplated	Stål	05001676	48:-
MERCEDES									
 A-klass W169, W176, B-klass W245, W246, C-klass W204, W205, CLA C117, CLS W218 W219, E-klass W207 W211, W212, SL R230, GL W164, GLK W204, ML W163, W164, Vito W639	000 990 67 07 000 990 69 07 000 990 72 07 000 990 49 07 163 401 06 70 211 401 03 70	14x1,50	27/49	Radius R14	17	10.9 Geomet	Aluminium	05002827	48:-
 CL W215, E-klass W213 G-klass W461, W463 GLC W204X GLK W204 (steel wheels only) ML W164 (steel wheels only) R-klass W25 (steel wheels only) S-klass W140, W220	000 990 53 07	14x1,50	45/70	Radius R14	17	10.9 Deltaprotekt KL100	Aluminium och stål	05002845	48:-
 A-klass W176 B-klass W246 C-klass W204, W205 CLA C117, C118 E-klass W207, W212 GL W164, W166 GLA (W156)	000 990 83 07	14x1,50	27/46	Radius R14	17	9.8 Corrolube	Aluminium	05002827	48:-

Bilmärke/bilmodell	Ersätter OEM art.nr.	Gänga	Gänglängd/ total längd (mm)	Kona	Skalle	Kvalitet/ material	Passar fälgtyp	Art.nr.	Pris Exkl
MERCEDES									
 CLS (C257) GL (W166) GLC (204X) ML (W166)	000 990 76 07	14x1,50	45/64	Radius R14	17	9.8 Corrolube	Aluminium	05002845	48:-
 GLE V167 18- C167 18-	PS17Q45-MW-ZN	15x1,25	45	Radius R14	17	8.8 Black Zincplated	Aluminium	05003141	84:-
 Sprinter I (207,209,209,210, 212,214,307,308,309 310,312,314) Sprinter II (906)	601 401 02 70	14x1,50	34/63	Radius R14	19	10.9 Zink, nickel + stål Finigard 105	Stål	05002834-2	48:-
 Sprinter (616 (905); Vario 512 (667) 612 (668), 814 (670), 815 (670) 609 (668); 709 (669)	074361014205	14x1,50		Flat	19	10 White Zincplated	Stål	05007016	48:-
MINI									
 Mini 10.01-10.06	06 36 13 0 141 574	12x1,50	26/51	Kona 60°	17	10.9 Black Zincplated	Stål och aluminium	05002622	48:-
 Clubman F54 Covertible F57 (3rd gen) Cooper F55, Cooper S F55/F56 Countryman R60 Cupe R58 One R56 Paceman R61 Raodster R59	36 13 6 781 151-03	14x1,25	27/48	Kona 60°	17	8.8 Black Zincplated	Stål och aluminium	05002923	48:-
MITSUBISHI									
 Carisma, Colt, Galant, Lancer, L300, Space Wagon	MR 297927 MA 103 087	12x1,50		Kona 60°	21	8 Yellow Zincplated	Stål	05001662	48:-

Bilmärke/bilmodell	Ersätter OEM art.nr.	Gänga	Gänglängd/ total längd (mm)	Kona	Skalle	Kvalitet/ material	Passar fälgtyp	Art.nr.	Pris Exkl
MITSUBISHI									
 ASX (GA0), Carisma (DA0), Colt (C50, CA0, CJO, Z30, Z3B), Galant (E30, EA0), I-Miev (HA0, HAV), Lancer (CS0, CY0), L300 (PA0, PAOV, POOV, POOW), Outlander (CUOW, CWO), Pajero (H60W), Space Wagon (N10, N30, N50)	90942-01053	12x1,50		Bricka	21	8 Chromeplated	Aluminium	05001697	48:-
NISSAN									
 Micra K12 04.03-05.10, Note E11 03.06-09.13	40254-00QAB 40222-BC40A	12x1,50	25/51	Kona 60°	19	10.9 White	Stål och aluminium	05002619	48:-
 Qashqai J10 02.07-11.13, X-Trail T30 09.01-06.07, X-Trail T31 07.07-04.14	40224-G9501 40224-21001	12x1,25		Kona 60°	21	8 Yellow Zincplated	Stål	05001560-3	48:-
OPEL									
 Corsa A-B-C, Agila, Astra, Vectra, Omega, Signum, Meriva, Zafira A-B	1.008.504	12x1,50	22/47,5	Kona 60°	17	10.9 White Zincplated	Stål och aluminium	05002617	48:-
 Crossland X	5405.66	12x1,25	26/47	Kona 60°	17	10.9 Geomet	Stål	05002526	48:-
 Crossland X Grandland X	5405.67	12x1,25	17/57	Bricka	17	10.9 Geomet	Aluminium	05002517	48:-
PEUGEOT									
 106, 205, 206, 306, 307, 309, 405, 406	5405.35	12x1,25	17/63	Bricka	19	10.9 Chromed	Aluminium	05002518	48:-

Bilmärke/bilmodell	Ersätter OEM art.nr.	Gänga	Gänglängd/ totallängd (mm)	Kona	Skalle	Kvalitet/ material	Passar fälgtyp	Art.nr.	Pris Exkl
PEUGEOT									
 308, 3008, 407, Partner Tepee 05.08-	5405.72	12x1,25	26/49	Kona 60°	17	10.9 Geomet	Stål	05002524	48:-
 106, 205, 206, 306, 307, 309, 405, 406	5405.55	12x1,25	26/52	Kona 60°	19	10.9 White Zincplated	Stål	05002511	48:-
 106, 206, 207, 406, 1007	5405.66	12x1,25	26/47	Kona 60°	17	10.9 Geomet	Stål	05002526	48:-
 1007, 206, 207, 307, 308, 3008, 406, 407, 508, 5008, Partner Tepee 05.08	5405.67	12x1,25	17/57	Bricka	17	10.9 Geomet	Aluminium	05002517	48:-
 107 09.05-06.14 108 07.14- (580W)	90942-W2002 5405.85	12x1,50	35/59,5	Bricka	17	10.9 Geomet	Aluminium	05002618	48:-
 807 09.02-11.10	5405.69	14x1,50	26/56,5	Kona 60°	17	10.9 Geomet	Aluminium	05002819	48:-
 4007 (V); 4008 (B)	5405.82	12x1,50		Bricka	21	8 Chromeplated	Aluminium	05001697	48:-
 Expert 01.96-09.06	5405.68	14x1,50	25/56,5	Kona 60°	17	10.9 Geomet	Stål	05002823	48:-

Bilmärke/bilmodell	Ersätter OEM art.nr.	Gänga	Gänglängd/ total längd (mm)	Kona	Skalle	Kvalitet/ material	Passar fälgtyp	Art.nr.	Pris Exkl
PEUGEOT									
 Boxer (lilla chassit) 03.94-03.02	5405.75	14x1,50	28/53	Kona 60°	24	10.9 Geomet	Stål	05002824	48:-
 Boxer (stora chassit) 03.94-03.02	5405.76	16x1,50	31/57	Kona 60°	24	10.9 Geomet	Stål	05003024	48:-
 Boxer (stora chassit) 04.02-05.06 Boxer (lilla chassit) 06.06-08.14	5405.78 5405.88	14x1,50	27/62	Kona 60°	21	10.9 Geomet	Stål och aluminium (endast 15" 5-118)	5002825	48:-
 Boxer (stora chassit) 06.06-08.14	5405.79	16x1,50	29/64	Kona 60°	21	10.9 Geomet	Stål och aluminium (endast 16" 5-130)	05003029	48:-
PORSCHE									
 911 (964), 924, 944	N 020 112 1	14x1,50		Radius R14	19	10 White Zincplated	Aluminium	05007021	48:-
 Boxter, Cayman, Panamera, 911 (930, 964, 993, 996, 997)	997 361 203 010	14x1,50	30/60	Radius R14	19	10.9 Deltaprotect KL100	Aluminium	05002839	84:-
 Macan	99635208602 WHT 006 978	14x1,50	30/60	Radius R14	19	10.9 Zinc nickel black	Aluminium	05002839-1	84:-
 Cayenne	7L0 601 139 A	14x1,50	37/67	Radius R14	19	10.9 White Zincplated	Aluminium	05002837	84:-
 Boxster, Cayman, 911		14x1,50		Radius stängd	19 Hex	Aluminium	Aluminium	05001875	84:-

Bilmärke/bilmodell	Ersätter OEM art.nr.	Gänga	Gänglängd/ total längd (mm)	Kona	Skalle	Kvalitet/ material	Passar fälgtyp	Art.nr.	Pris Exkl
SEAT									
 Toledo, Leon , Altea, Ibiza 07.08-, Cordoba 01.03- Exeo 03.09-	WHT 002 437	14x1,50	27/47,5	Radius R13	17	10.9 White Zincplated	Stål och aluminium	05002828	48:-
 Alhambra 05.96-04.01	701 601 139B	14x1,50	34/55	Radius R14	19	10.9 Phosphated	Stål och aluminium	05002898	48:-
 Alhambra 05.01-08.10	7M3 601 139B	14x1,50	34/62	Radius R14	19	10.9 Dacromet	Stål och aluminium	05002834	48:-
SKODA									
 Fabia, Octavia 04.97-05.04, Octavia 06.04-05.13, Roomster, Superb	WHT 002 437	14x1,50	27/47,5	Radius R13	17	10.9 White Zincplated	Stål och aluminium	05002828	48:-
SUZUKI									
 Ignis 09.03- SX-4 06.06-11.13, Swift III 05.05-	43423-86G00	12x1,50	22/47,5	Kona 60°	17	10.9 White Zincplated	Stål och aluminium	05002617	48:-
TESLA									
 Model S, Model X	ACPA-1012-KXA	14x1,50		Kona 60°	21	10.9 White Zincplated 2 Pcs	Aluminium	05001873-2	84:-
TOYOTA									
 Auris, Avensis, Carina, Corolla, Camry, Yaris, 4 Runner	90942-01007	12x1,50		Kona 60°	21	8 Yellow Zincplated	Stål	05001662	48:-
 Alla Toyota personbilar	90942-01033	12x1,50		Bricka	21	8 Chromeplated	Aluminium	05001697	48:-

Bilmärke/bilmodell	Ersätter OEM art.nr.	Gänga	Gänglängd/ totallängd (mm)	Kona	Skalle	Kvalitet/ material	Passar fälgtyp	Art.nr.	Pris Exkl
TOYOTA									
 4 Runner, Land Cruiser, Prado, Rav4, Highlander	90942-01858	12x1,50		Bricka	21	8 Chromeplated	Aluminium	05001696	48:-
 Toyota Tundra, Land Cruiser 100-200-400	90942-01103	14x1,50		Bricka	22	8 Chromeplated	Aluminium	05001897	48:-
 Aygo 07.05-06.14 Aygo 07.14- (580W)	90942-W2002 5405.85	12x1,50	35/59,5	Bricka	17	10.9 Geomet	Aluminium	05002618	48:-
 Proace (V)	5405.67	12x1,25	17/57	Bricka	17	10.9 Geomet	Aluminium	05002517	48:-
 Proace (V)	160 873 44 80	12x1,25	26/49	Kona 60°	17	10.9 Geomet	Stål	05002524	48:-
VOLKSWAGEN									
 Transporter T2; Transporter T3	N 020 112 1	14x1,50 R14		Radius Zincplated	19	10 White	Aluminium	05007021	48:-
 Caddy 09.96-12.03, Golf I, II, III, Jetta I, II, Lupo 10.98-03.05, Vento 01.92-09.98	321601139 C 3A0 601 139	12x1,50	23,5/45,5	Radius R13	17	8.8 Yellow Zincplated	Stål och aluminium	05002623	48:-
 Sharan 05.95-04.01, Transporter T4 01.96-04.03	701 601 139 B 7M0 601 139A	14x1,50	34/55	Radius R14	19	10.9 Phosphated	Stål och aluminium	05002898	48:-

Bilmärke/bilmodell	Ersätter OEM art.nr.	Gänga	Gänglängd/ totallängd (mm)	Kona	Skalle	Kvalitet/ material	Passar fälgtyp	Art.nr.	Pris Exkl
VOLKSWAGEN									
 Sharan 05.01-04.10, Transporter T4 04.00-04.03	7M3 601 139 B	14x1,50	34/62	Radius R14	19	10.9 Dacromet	Stål och aluminium	05002834	48:-
 Bora, Beetle 10.98-09.11, Fox 04.05-, Golf IV, V, VI, VII, Passat 10.96-09.10, Phaeton, Tiguan 10.07- Touran 03.03-	8D0 601 139 D	14x1,50	27/47,5	Radius R13	17	10.9 White Zincplated	Stål och aluminium	05002828	48:-
 Touareg 10.02-04.10, Transporter T5	443 601 139 A 7L0 601 139 A	14x1,50	37/67	Radius R14	19	10.9 White Zincplated	Aluminium	05002837	84:-
 Touareg (CR)	8R0 601 295	14x1,50	30/59,5	Radius R14	17	10.9 Deltaprotekt KL100	Stål och aluminium	05002846	84:-
 Crafter 30/35 (2EC1,2FJ) LT28/35 (2Dm)		14x1,50	34/63	Radius R14	19	10.9 Zink Nickel + Finigard 105	Stål	05002834-2	48:-
VOLVO									
 S40 03.96-12.03, V40 03.96-12.03	30870000 30873148	12x1,50		Kona 60°	21	8 Yellow Zincplated	Stål	05001662	48:-
 S40 01.04-04.12, V50 04.04-04.12	8665333 999359	12x1,50		Kona 60°	19	8 Phosphated	Stål	05001663	48:-
 S60, S80, V70, XC70, XC90	31202337 30683076	14x1,50	34/60	Kona 60°	19	10.9 White Zincplated	Stål och aluminium	05002835	48:-
 C30, S40/V50, V40	3132645	12x1,50		Kona 60°	19	10 Stainless steel	Aluminium (öppen)	05001698	48:-

TPMS kompletta



Bild	Art. nr	Benämning	Antal/förp	Pris ex. moms
1	050099150	TPMS Italsensor 3.0evo snap-in 433 Mhz	30	470:-
2	050099151	TPMS Italsensor 3.0evo clamp-in Slv 433 Mhz	30	470:-
3	050099152	TPMS Italsensor 3.0evo clamp-in Blk 433 Mhz	30	470:-
9	050099155	TPMS Italsensor Tesla direct fit bluetooth Slv	30	870:-
10	050099156	TPMS Italsensor Tesla direct fit bluetooth Blk	30	870:-
4	050099114-2	TPMS Sensor CUB clamp-in 433 Mhz Combo silver (small)	20	498:-
5	050099115-1	TPMS Sensor CUB clamp-in 433 Mhz Combo svart (small)	20	498:-
6	050099116	TPMS Sensor CUB snap-in 433 Mhz Combo svart	20	498:-
7	050099116-1	TPMS Sensor CUB snap-in 433 Mhz (small)	20	498:-
8	050099117	TPMS Sensor CUB clamp-in 315 Mhz Combo silver	20	498:-
11	050099121	TPMS Sensor CUB Tesla direct fit bluetooth silver	20	900:-

TPMS ersättningsventiler



Bild	Art. nr	Benämning	Antal/förp	Pris ex. moms
1	050099161	Ersättningsventil snap-in för Italsensor 3.0evo (10 st)	10	400:-
1	050099161-1	Ersättningsventil snap-in för Italsensor 3.0evo (1 st)	1	44:-
2	050099162	Ersättningsventil clamp-in silver Italsensor 3.0evo (10 st)	10	500:-
2	050099162-1	Ersättningsventil clamp-in silver Italsensor 3.0evo (1 st)	1	55:-
3	050099163	Ersättningsventil clamp-in svart Italsensor 3.0evo (10 st)	10	500:-
3	050099163-1	Ersättningsventil clamp-in svart Italsensor 3.0evo (1 st)	1	55:-
4	050099164	Ersättningsventil clamp-in grå Italsensor 3.0evo (10 st)	10	500:-
4	050099164-1	Ersättningsventil clamp-in grå Italsensor 3.0evo (1 st)	1	55:-
5	050099165	Ersättningsventil snap-in Schrader Highspeed	1	37:-
6	050099166	Ersättningsventil snap-in TPMS Schrader Gen 4	1	48:-
7	050099167	Ersättningsventil snap-in TPMS Conti TG1D	1	68:-
8	050099168	Ersättningsventil snap-in TPMS Pacific	1	72:-

TPMS programmeringsverktyg



Bild	Art. nr	Benämning	Antal/förp	Pris ex. moms
1	0500990013	IT46 Italsensor programmeringsverktyg med OBD 5Y*	1	7996:-
2	0500990014	IT41 Italsensor programmeringsverktyg med OBD 5Y*	1	6996:-
3	0500990015	IT56 Italsensor programmeringsverktyg med OBD 3Y*	1	14898:-
4	050099001	CUB programmeringsverktyg Gen 4 med OBD	1	13335:-
5	050099199	TPMS verktygskit	1	3190:-

*(3Y = 3 års fri uppdatering på samtliga Ateq-protokoll ingår, 5Y = 5 års fri uppdatering på Italmatics protokoll ingår)

Ventiler



Bild	Art. nr	Benämning	Antal/förp	Pris ex. moms
1	05009181	Ventil PV TR413 monterad	100	288:-
2	05009181-1	Ventil PV TR413 lös hatt	100	288:-
3	05009181-2	Ventil PV TR413 lös hatt och nål	100	288:-
4	05009182	Ventil PV TR414 monterad	100	308:-
5	05009182-1	Ventil PV TR414 lös hatt	100	308:-
6	05009182-2	Ventil PV TR414 lös hatt och nål	100	308:-
7	05009183	Förstärkt ventil TR600XHP 6,9 bar	1	24:-
8	05009184	Förstärkt skruvventil metall 14 bar	1	48:-
9	05009008	Ventil krom TR413	1	24:-
10	05009011	Ventil skruv dold / 4-pack	4	320:-
11	05009185	Ventil PV TR412 lös hatt	100	308:-
12	05009186	Ventil PV TR415 monterad Ø15,7mm	100	560:-
7	05009187	Förstärkt ventil TR801HP 5,5 bar Ø15,7mm	1	24:-

Ventildelar



Bild	Art. nr	Benämning	Antal/förp	Pris ex. moms
1	05009180-1	Ventilnål mässing	100	139:-
2	05009180-2	Ventilnål nickelbelagd (även för TPMS)	100	139:-
3	05009180-3	Ventilhatt svart	100	58:-

Lastbilsventiler



Bild	Art. nr	Benämning	Antal/förp	Pris ex. moms
1	05009200	Ventil LV TBL 1390 (Alive)	1	96:-
2	05009201	Ventil LV Trailer för Super singel	1	96:-
3	05009202	Ventil LV 764 längd 90 mm	1	96:-
4	05009203	Ventil LV 65MSF längd 40 mm	1	96:-
5	05009204	Ventil LV TR-571-C längd 57 mm	1	96:-
6	05009205	Ventil LV TR-573-C längd 82 mm	1	96:-
7	05009206	Ventil LV Trailer (litet ventilhål) för Super singel	1	96:-
8	05009207	Ventil LV Trailer (omvänd) för Super singel	1	96:-

Zinkvikter personbil stålfälg



Bild	Art. nr	Benämning	Antal/förp	Pris ex. moms
1	05009101	5 g zinkvikt PV med clips stålfälg	100	220:-
2	05009102	10 g zinkvikt PV med clips stålfälg	100	320:-
3	05009103	15 g zinkvikt PV med clips stålfälg	100	408:-
4	05009104	20 g zinkvikt PV med clips stålfälg	100	496:-
5	05009105	25 g zinkvikt PV med clips stålfälg	100	590:-
6	05009106	30 g zinkvikt PV med clips stålfälg	100	690:-
7	05009107	35 g zinkvikt PV med clips stålfälg	50	376:-
8	05009108	40 g zinkvikt PV med clips stålfälg	50	440:-
9	05009109	45 g zinkvikt PV med clips stålfälg	50	476:-
10	05009110	50 g zinkvikt PV med clips stålfälg	50	528:-

Zinkvikter personbil aluminiumfälg



Bild	Art. nr	Benämning	Antal/förp	Pris ex. moms
1	05009121	5 g zinkvikt PV med clips aluminiumfälg	100	200:-
2	05009122	10 g zinkvikt PV med clips aluminiumfälg	100	296:-
3	05009123	15 g zinkvikt PV med clips aluminiumfälg	100	376:-
4	05009124	20 g zinkvikt PV med clips aluminiumfälg	100	472:-
5	05009125	25 g zinkvikt PV med clips aluminiumfälg	100	540:-
6	05009126	30 g zinkvikt PV med clips aluminiumfälg	100	628:-
7	05009127	35 g zinkvikt PV med clips aluminiumfälg	50	348:-
8	05009128	40 g zinkvikt PV med clips aluminiumfälg	50	416:-
9	05009129	45 g zinkvikt PV med clips aluminiumfälg	50	456:-
10	05009130	50 g zinkvikt PV med clips aluminiumfälg	50	496:-

Klistervikter stål personbil



Bild	Art. nr	Benämning	Antal/förp	Pris ex. moms
1	05009143	Klistervikt stål PV grå 60 g (4x5 g + 4x10 g)	100	560:-
2	05009144	Klistervikt stål PV svart 60 g (4x5 g + 4x10 g)	100	588:-

Klistervikter stål personbil rulle

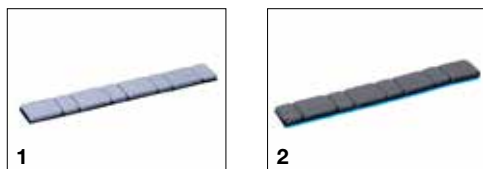

Bild	Art. nr	Benämning	Antal/förp	Pris ex. moms
1	05009154	Klistervikt stål PV rulle 5 kg	1	840:-
2	05009155	Klistervikt stål PV grå rulle 5 kg	1	896:-
3	05009156	Klistervikt stål PV svart rulle 5 kg	1	936:-

Blyvikter lastbil



Bild	Art. nr	Benämning	Antal/förp	Pris ex. moms
1	05009131	50 g blyvikt LV med clips	50	656:-
2	05009132	75 g blyvikt LV med clips	50	748:-
3	05009133	100 g blyvikt LV med clips	50	916:-
4	05009134	150 g blyvikt LV med clips	25	640:-
5	05009135	200 g blyvikt LV med clips	25	820:-
6	05009136	250 g blyvikt LV med clips	25	980:-
7	05009137	300 g blyvikt LV med clips	20	928:-

Klistervikter bly lastbil



Bild	Art. nr	Benämning	Antal/förp	Pris ex. moms
1	05009161	Klistervikt bly LV 100 g (4x25 g)	25	596:-
2	05009162	Klistervikt bly LV 200 g (4x50 g)	25	1088:-

Klistervikter bly motorcykel

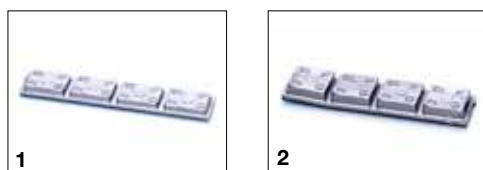

Bild	Art. nr	Benämning	Antal/förp	Pris ex. moms
1	05009166	Klistervikt bly MC 50 g (7x5 g + 6x2,5 g)	100	1176:-
2	05009167	Klistervikt bly MC svart 50 g (7x5 g + 6x2,5 g)	100	1860:-

Monteringspasta och tillbehör



1

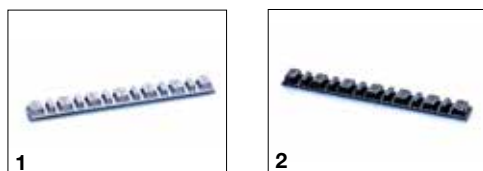

2



3



4



5



6



7

Bild	Art. nr	Benämning	Antal/förp	Pris ex. moms
1	05009191	Monteringspasta PV vit 5 kg	1	252:-
2	05009192	Monteringspasta PV transparent 5 kg	1	288:-
3	05009193	Monteringspasta LV Michelin 4 kg	1	698:-
4	05009195	Pastaborste rak	1	68:-
5	05009196	Pastaborste vinklad	1	236:-
6	05009199	Däckkrita vit 17,5 mm	12	388:-
7	050099231	Hållare för däckkrita	1	56:-

Trissor, ventildragare och mejslar



1



2



3



4



5



6

Bild	Art. nr	Benämning	Antal/förp	Pris ex. moms
1	050099201	Gummitrissa för borttagning av klisterrester 6 mm fäste	1	176:-
2	050099202	Tandad gummitrissa för borttagning av klisterrester	1	196:-
3	050099211	Ventildragare med gummiskydd	1	108:-
4	050099212	Ventilnålsmejsel	1	32:-
5	050099204	Mejsel för borttagning av klistervikter	1	98:-
6	050099205	Tång för borttagning av vikter	1	272:-

Däckjärn



1



2



3



4

Bild	Art. nr	Benämning	Antal/förp	Pris ex. moms
1	050099221	Däckjärn PV 500 mm	1	176:-
2	050099222	Däckjärn LV 800 mm	1	1180:-
3	050099223	Däckjärn LV 520 mm	1	976:-
4	050099224	Klinchlåstång	1	2576:-

Hylsor



Bild	Art. nr	Benämning	Antal/förp	Pris ex. moms
1	050099281	Hylsa slim för aluminiumfälg 17 mm	1	192:-
2	050099281-1	Hylsa slim för aluminiumfälg 19 mm	1	192:-
3	050099281-2	Hylsa slim för aluminiumfälg 21 mm	1	192:-

Lyftblock



Bild	Art. nr	Benämning	Antal/förp	Pris ex. moms
1	050099291	Lyftblock gummi för fordonslyft 160x120x40 (mm)	1	208:-
2	050099292	Lyftblock gummi för fordonslyft 160x120x60 (mm)	1	228:-
3	050099293	Lyftblock gummi för fordonslyft 160x120x70 (mm)	1	248:-
4	050099294	Lyftblock gummi för fordonslyft 160x120x80 (mm)	1	260:-
5	050099295	Rund lyftpuck gummi för fordonslyft Ø 76, H 25 (mm)	1	196:-

Hållare och ställ



Bild	Art. nr	Benämning	Antal/förp	Pris ex. moms
1	050099241	Hållare klisterviktsrulle med viktskala och klippare	1	3780:-
2	050099242	Golvställ till hållare klisterviktsrulle	1	2180:-
3	050099243	Extra knivblad	2	398:-
4	050099244	Extra handtag till klippare	1	1298:-





Mätverktyg

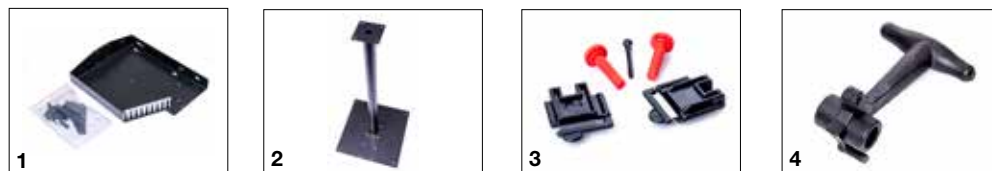



Bild	Art. nr	Benämning	Antal/förp	Pris ex. moms
1	358	Gängprovartavla HC (Plast)	1	800:-
2	353	Bultcirkelmätare	1	200:-
3	355	Gängtolk (Fickmodell)	1	400:-
4	354	Centrumhålsmätare 54-90 mm	1	500:-
5	188	Mutter/Bult Påse SpF	1	40:-



SPEEDLINE TRUCKS ventiler är speciellt tillverkade för smidda lättmetallfälgar. Nedanstående rekommenderade momentvärden gäller endast för original SPEEDLINE TRUCK-ventiler. För alla liknande ETRTO ventiltypen nämnda som alternativ nedan, vänligen använd de momentvärden respektive producent rekommenderar.

Typ	Fälgstorlekar som passar	SPEEDLINE TRUCK-fälgar som passar	Lev. Art.Nr	Artikelnummer	Tekniska detaljer	Anmärkningar
SLT-003 	17.5x6.75" 22.5x8.25" 22.5x9.00"	SLT 2901, SLT 2911, SLT 2900, SLT 2897, SLT 2907	SLT-003	05009213	TRA typ: TR 553 DIN 54MS	Rekommenderat moment: 3-5 Nm
SLT-004 	17.5x6.75"	SLT 2891, SLT 3086	SLT-004	05009214	TRA typ: TR 544C ETRTO typ: V3.22.1	Rekommenderat moment: 3-5 Nm
SLT-020 	19.5x7.50", 22.5x11.75", ET0 22.5x13.00"	SLT 3087, SLT 2889, SLT 3099, SLT 3187	SLT-020	05009209	TRA typ: TR 543C ETRTO typ: V3.22.1	Rekommenderat moment: 3-5 Nm
SLT-021 	19.5x14.00" ET 120 22.5x11.75" ET 0, ET 45 ET 120, ET 135	SLT 2899, SLT 2888, SLT 2898, SLT 3063, SLT 3598, SLT 3774	SLT-021	05009210	TRA typ: TR 542 ETRTO typ: V3.20.1	Rekommenderat moment: 3-5 Nm
SLT-022 	22.5x7.50" 22.5x9.00"	SLT 3201, SLT 3211, SLT 2887	SLT-022	05009215	DIN 70MS-07	Rekommenderat moment: 3-5 Nm

Ventilförlängningar

Förlängningsbas 	45° för dubbelmontage	För alla dimensioner i dubbelmontage, vid extern hjulposition	SLT-007	05009216	Material: mässing	-
Ventilförlängningar 	115 mm längd 150 mm längd	SLT 2901, SLT 2911, SLT 3086, SLT 3087 SLT 2900, SLT 3201, SLT 3211, SLT 2887, SLT 2897, SLT 2907	SLT-008 SLT-009	05009211 05009212	Material: technopolymer	-

Mutter/bult-sortiment

Spara fraktkostnader och hjälp kunden (och dig själv) direkt, genom att ha de mest vanliga muttrar och bultar i lager.

Innehåller 18 st. olika artikelnummer, med totalt 720 st mutter och bult.
Både eftermarknad och OE.



OE Innehåller följande

05001670	Mutter 12x1,50 Kona Stängd (19Hex) H34
05002530	Bult 12x1,25 Kona L28 (17Hex)
05002620	Bult 12x1,50 Kona L26 (17Hex)
05002830	Bult 14x1,50 Kona L28 (17Hex)
05002927	Bult 14x1,25 Kona L27 (17Hex)
05002601	Bult 12x1,50 Radius L21 (17Hex)
05002821	Bult 14x1,50 Radius L27 (17Hex)
05001671	Mutter 12x1,50 Radius Stängd H27 (19Hex) (O.E Honda)
05001697	Mutter 12x1,50 Bricka Stängd (21Hex) (O.E Toyota)
05001698	Mutter 12x1,50 Lös Kona Stängd (19Hex) (O.E Ford)
05001879	Mutter 14x1,50 Lös Kona Stängd (21Hex) (O.E Ford)
05002517	Bult 12x1,25 Bricka L17 (17Hex) (O.E Citroen/Peugeot)
05002518	Bult 12x1,25 Bricka L17 (19hex) (O.E Peugeot)
05002834	Bult 14x1,50 Radius L34 (19 Hex) (R14) (O.E Seat, Vw)
05002835	Bult 14x1,50 Kona L34 (19Hex) (O.E Volvo)
05002922	Bult 14x1,25 Kona L27 (17Hex) Blk (O.E BMW)
05003024	Bult 16x1,50 Kona L31 (24Hex) (O.E Fiat)

Black Edition innehåller följande

05001572	Mutter 12x1,25 Kona Stängd (19 Hex) H34 Svart
05001672	Mutter 12x1,50 Kona Stängd (19 Hex) H34 Svart
05002522	Bult 12x1,25 Kona L26 (17 Hex) Svart
05002622	Bult 12x1,50 Kona L26 (17 Hex) Svart
05002832	Bult 14x1,50 Kona L28 (17 Hex) Svart
05002833	Bult 14x1,50 Radius L27 (17 Hex) Svart
05002898	Bult 14x1,50 Radius L34 D Kona 27 (19 Hex)
05002922	Bult 14x1,25 Kona L27 (17 Hex) Svart
05002923	Bult 14x1,25 Kona L27 (17 Hex) Svart
05002932	Bult 14x1,25 Radius L30 (17 Hex) Svart
050028502	Bult 14x1,50 Kona L33 (17 Hex) Svart
050028512	Bult 14x1,50 Radius L35 (17 Hex) Svart
050028702	Bult 14x1,50 Kona L45 (17 Hex) Svart
050028712	Bult 14x1,50 Radius L45 (17 Hex) Svart
050029452	Bult 14x1,25 Kona L43 (17 Hex) Svart
05001872-2	Mutter 14x1,50 Kona Stängd (19 Hex) H41 Svart
05002827-1	Bult 14x1,50 Radius L27 (17 Hex) R14 Svart
05002845-1	Bult 14x1,50 Radius L45/64 (17 Hex) R14 Svart

Låssatser

Komplett låssortiment med de vanligaste låssatserna. Totalt 45 st satser.



Artikelnummer	Beskrivning
0500459030	Låsbult 12x1,25 KONA 30 mm
0500469023	Låsbult 12x1,50 KONA 23 mm
0500469026	Låsbult 12x1,50 KONA 26 mm
0500469033	Låsbult 12x1,50 KONA 33 mm
0500479033	Låsbult 12x1,75 KONA 33 mm
0500489026	Låsbult 14x1,50 KONA 26 mm
0500489033	Låsbult 14x1,50 KONA 33 mm
0500499027	Låsbult 14x1,25 KONA 27 mm
0500469123	Låsbult 12x1,50 RADIUS 23 mm
0500469127	Låsbult 12x1,50 RADIUS 27 mm
0500489129	Låsbult 14x1,50 RADIUS 29 mm
0500457000	Låsmutter 12x1,25 KONA Stängd
0500466000	Låsmutter 12x1,50 KONA Öppen
0500467000	Låsmutter 12x1,50 KONA Stängd
0500487000	Låsmutter 14x1,50 KONA Stängd

Ringsortiment

Spara fraktkostnader och hjälp kunden (och dig själv) direkt, genom att ha de vanligaste centreringsringarna från Specialfälgar i lager.

Innehåller 30 st. olika artikelnummer och finns två olika utföranden, 120 st. ringar eller 240 st. ringar



Artikelnummer	Beskrivning
601571	Centrumringar 60,1-57,1
633541	Centrumringar 63,3-54,1
633561	Centrumringar 63,3-56,1
633566	Centrumringar 63,3-56,6
633571	Centrumringar 63,3-57,1
633601	Centrumringar 63,3-60,1
651634	Centrumringar 65,1-63,4
666571	Centrumringar 66,6-57,1
671571	Centrumringar 67,1-57,1
671651	Centrumringar 67,1-65,1
731541	Centrumringar 73,1-54,1
731561	Centrumringar 73,1-56,1
731566	Centrumringar 73,1-56,6
731571	Centrumringar 73,1-57,1
731581	Centrumringar 73,1-58,1

Artikelnummer	Beskrivning
731601	Centrumringar 73,1-60,1
731634	Centrumringar 73,1-63,4
731641	Centrumringar 73,1-64,1
731651	Centrumringar 73,1-65,1
731661	Centrumringar 73,1-66,1
731666	Centrumringar 73,1-66,6
731671	Centrumringar 73,1-67,1
731703	Centrumringar 73,1-70,3
731711	Centrumringar 73,1-71,1
731715	Centrumringar 73,1-71,5
741571	Centrumringar 74,1-57,1
741651	Centrumringar 74,1-65,1
741666	Centrumringar 74,1-66,6
741703	Centrumringar 74,1-70,3
741725	Centrumringar 74,1-72,5

PRISER & ALLMÄNT

- Denna prislista annullerar föregående. Specialfälgar i Kungsbacka AB (härefter benämnt i villkoren som Specialfälgar) förbehåller sig rätten att omgående ändra priserna vid t ex kraftiga valuta- eller råvaruförändringar med avisering senast 30 dagar innan.
- Beställningar faktureras alltid till de priser som gäller leveransdagen oberoende av beställningsdatum.
- Vid order understigande 500 kr tillkommer en expeditionsavgift om 25 kr exkl. moms.
- Specialfälgar försöker i största möjliga mån att ha dagsuppdaterad information vad gäller bilmodeller, passningslistor, bil-fälgkopplingar och aktuella registreringsnummerkopplingar. Det åligger dock alltid kunden att kontrollera senast inkommen information innan fälgarna monteras på bilen. Specialfälgar står aldrig för eventuella skador som uppkommit på bilen eller fälgen när fälgar eller tillbehör monteras.

BETALNINGSVILLKOR

- Efter sedvanlig kreditprövning bestäms betalningsvillkoren. Specialfälgar förbehåller sig rätten att neka kunder köp.
- Specialfälgar förbehåller sig rätten att när som helst, utan föregående avisering, att lägga kunder mot Förskottsbetalning eller spärra kundkontot för vidare köp.
- Efter förfallodagen debiteras en dröjsmålsränta med f.n. 12%.

RETURER/REKLAMATIONER

- Alla eventuella reklamationer och/eller returerna skall föregås av samtal med Specialfälgar.
- Felleverans måste meddelas Specialfälgar inom 10 arbetsdagar, därefter kommer eventuella returerna inte att accepteras.
- På returerna/reklamationer utan retursedel debiteras en hanteringskostnad om 250 kr exkl. moms.
- För returnerade varor som ej är rengjorda eller skadats av exempelvis felaktig emballering görs avdrag om upp till 100 % på kreditnotan.
- På varor som ej returnerats i originalkartong görs ett avdrag om 10 % på kreditnotan.
- Ej godkända returerna skickas tillbaka till avsändaren med mottagarfrakt och en hanteringskostnad debiteras om 250 kr exkl. moms.

TRANSPORTSKADOR

- Kontrollera alltid att mottaget gods är oskadat och komplett i samråd med transportören direkt vid mottagandet. Skriv aldrig på gods du inte fysiskt sett.
- Ansvaret för att anmäla eventuella transportskadorna åligger alltid mottagande part.
- Anmälan av dold transportskada skall göras till transportören inom 7 arbetsdagar.
- Vid nekad ersättning från transportör står aldrig Specialfälgar skyldig att ersätta mottagande part.

MONTERING

- Innan du monterar däcken, provmontera fälgarna på bilen. Finns det inte möjlighet till detta så kontrollera att bult-cirkel och inpressning stämmer med din beställning och, vid fullgången restorder, senaste uppgifterna om fälg-bilpassingen tillgängliga hos Specialfälgar.
- Kontrollera att fälgarna monteras kloss an bilens anläggningsyta. I vissa fall krävs det att man demonterar små skruvar, brickor eller dylikt.
- Demontera ALDRIG detaljer som påverkar bilens funktionalitet och/eller säkerhet.
- Se till att både bilens och fälgens anläggningsytor är jämna och rena.
- Om monteringskit medföljer fälgen skall detta användas. Kontrollera eventuella centrumringars mått, bultarnas längd och muttrarnas djup så att dessa ej tar i några bromsdetaljer eller bottnar i skallen etc.
- Använd lämpligt vattenbaserat smörjmedel på däckfoten för att underlätta monteringen och var noga med att inte skrapa monteringsverktyget mot fälgkanten eller ekrarna vid montering.
- Muttermaskin bör ej användas vid montering av lättmetallfälgar.
- Efterdra muttrarna/bultarna efter c:a 10 mils körning.

Specialfälgar ansvarar aldrig för eventuella skador som kan uppstå genom användandet av våra produkter, ej heller för monterings- och servicekostnader vid om-/av-/påläggning av däck eller eventuellt merjobb med ompackning och transport. Specialfälgar kommer aldrig att stå för uppkomna merkostnader för produkter vi inte levererar, exempelvis däck eller liknande.

HELBILSGODKÄNNANDE

- För att ta reda på om bilen är godkänd för en viss typ av fälg, hänvisas till respektive bilmärkesrepresentant. Specialfälgar tar inget ansvar för icke godkända dimensioner och spårvidder till enskilda bilmodeller. Rådfråga din lokala gummiverkstad.
 - I katalog/fälgguide uppger vi originalinpressning på samtliga europeiska bilar samt inpressningsdjupet på våra fälgar.
 - Observera att avvikelser kan förekomma för vissa bilar där vi uppger att originalkåpa, originalmutter/bult samt centrumhål passar.
 - Vid användandet av fälgar från Specialfälgar kan i vissa fall modifiering av skärmkanter eller hårdare fjädrar och stötdämpare erfordras.
 - När vi säljer en originalanpassad fälg till en nyare bil, där original mutter/bult passar, skickar vi inte med mutter/bult!
- Specialfälgar ansvarar ej för problem uppkomna vid användandet av fälgar listade i denna katalog gentemot "Helbilsgodkännandet".**

GARANTI

- Vi lämnar tre (3) års garanti på samtliga produkter fr.o.m. försäljningsdatum. Undantaget alla kromfälgar där vi lämnar ett (1) års garanti.
- Undantag från garantin:
Skador på fälgar som orsakas av stenskott, felaktig rengöring, vägsalt, bromsdamm eller yttre påverkan. Skador på fälgar som orsakas av felaktig hantering vid montering, demontering eller balansering.
- Teknisk support och eventuella garantianspråk rörande TPMS-sensorer (med tillbehör) hänvisas för Italmatic till Specialfälgar (tel. 0300-729 00) respektive CUB till SECUB AB (tel. 08-64 64 211).

SPECIALFÄLGAR I KUNGSBACKA AB

Borgåsvägen 2, 434 39 Kungsbacka
Tel. 0300-729 00 E-mail: info@specialfalgar.se



Fälgdim.	Art.nr.	Lev.- art.nr	Bultcirkel	Navhål (mm)	Inpr. (mm)	Bulthål	Bult/nav centr.	Typ	Max.bel. (kg)	Antal/ pall	Anm.
6,00x17,5	600 600 175 10	14020V*	6-205	161	116	Kona	(MZ)	Std	1550	20	
6,00x17,5	600 600 175 11	35038V*	6-245	202	114,5	Rak M18	MZ	ALV	1850	20	
6,00x17,5	600 600 175 09	14008V*	6-245	202	121,5	Rak M18	MZ	ALV	1850	20	
6,00x17,5	600 600 175 06	14014V*	6-245	191	121,5	Rak M20	MZ	ALV	1850	20	
6,00x17,5	600 600 175 05	14015V*	10-225	176	122,5	Kona	(MZ)	Std	3150	20	
6,75x17,5	600 675 175 03	14019V*	6-205	161	0	Kona	(MZ)	ALV	2725	20	
6,75x17,5	600 675 175 10	35037V*	6-245	202	128	Rak M18	MZ	ALV	2240	20	
6,75x17,5	600 675 175 12	14009V*	6-245	202	145	Rak M18	MZ	ALV	2360	20	
6,75x17,5	600 675 175 11	14007V*	8-275	221	135	Rak M20	MZ	ALV	2360	20	
6,75x17,5	600 675 175 05	14017V*	10-225	176	128	Kona	(MZ)	Std	3150	20	
6,75x19,5	600 675 195 04	35367V*	8-275	221	133	Kona	(MZ)	ALV	2500	16	U DCW-G3
6,75x19,5	600 675 195 05	35366V*	8-275	221	133	Rak M20	MZ	ALV	2500	16	U DCW-G3
7,50x19,5	600 750 195 07	35368V*	8-275	221	138	Rak M22	MZ	ALV	2800	16	U DCW-G3
7,50x19,5	600 750 195 04	35370V*	8-275	221	144	Kona	(MZ)	ALV	3000	16	U DCW-G3
7,50x19,5	600 750 195 05	35369V*	8-275	221	144	Rak M20	MZ	ALV	3000	16	U DCW-G3
7,50x19,5	600 750 195 10	35552V*	10-225	176	140	Kona	(MZ)	Std	2725	16	U DCW-G3
8,25x19,5	600 825 195 08	35371V*	8-275	221	157	Rak M20	MZ	ALV	3150	16	U DCW-G3
8,25x19,5	600 825 195 09	35555V*	8-275	221	65	Rak M22	MZ	Std	3150	16	U DCW-G3
8,25x19,5	600 825 195 06	35553V*	10-225	176	66	Rak M22	MZ	ALV	3750	16	U DCW-G3
8,25x19,5	600 825 195 03	35503V*	10-225	176	148	-	(MZ)	Std	3150	16	U DCW-G3
11,75x19,5	60 1175 195 03	35422V*	10-335	281	120	Rak M22	MZ	ALV	4500	12	
14,00x19,5	60 1400 195 04	35426V*	8-275	221	0	Rak M22	MZ	ALV	4500	8	
14,00x19,5	60 1400 195 05	35424V*	10-335	281	0	Rak M22	MZ	ALV	4500	8	
14,00x19,5	60 1400 195 06	35425V*	10-335	281	120	Rak M22	MZ	ALV	4500	8	
6,75x22,5	600 675 225 03	15130V*	8-275	221	132	Rak M20	MZ	Std	2800	12	
7,50x22,5	600 750 225 10	15096V*	8-275	221	141,5	Rak M20	MZ	ALV	3150	12	
7,50x22,5	600 750 225 02	15124V*	8-275	221	147	Rak M20	MZ	ALV	3250	12	U DCW-G3
7,50x22,5	600 750 225 12	15121V*	10-335	281	148	Rak M22	MZ	ALV	3750	12	U DCW-G3
7,50x22,5	600 750 225 15	15107V*	10-335	281	152,5	Rak M22	MZ	ALV	3250	12	U DCW-G3
7,50x22,5	600 750 225 14	15123V*	10-335	281	88	Rak M22	MZ	ALV	3550	12	U DCW-G3
8,25x22,5	600 825 225 12	15098V*	10-335	281	152	Rak M22	MZ	ALV	3750	12	U DCW-G3
8,25x22,5	600 825 225 02	15119V*	10-335	281	157	Rak M22	MZ	ALV	3750	12	U DCW-G3
9,00x22,5	600 900 225 10	15145V*	10-335	281	162,5	Rak M22	MZ	ALV	4000	12	U DCW-G3
9,00x22,5	600 900 225 09	35470V*	10-335	281	120	Rak M22	MZ	Std	4000	12	U DCW-G3

För pallpriser, rådfråga oss!



Fälgdim.	Art.nr.	Lev.- art.nr	Bultcirkel ex. moms	Navhål (mm)	Inpr. (mm)	Bulthål	Bult/nav centr.	Typ	Max.bel. (kg)	Antal/ pall	Anm.
11,75x22,5	60 1175 225 07	35054V	10-335	281	0	Kona	(MZ)	ALV	5000	12	
11,75x22,5	60 1175 225 15	15084V*	10-335	281	0	Rak M22	MZ	ALV	5000	12	
11,75x22,5	60 1175 225 24	15122V*	10-335	281	45	Rak M22	MZ	ALV	5000	12	
11,75x22,5	60 1175 225 06	15083V*	10-335	281	120	Rak M22	MZ	ALV	5000	12	
11,75x22,5	60 1175 225 11	15073V*	10-335	281	135	Rak M22	MZ	ALV	5000	12	
13,00x22,5	60 1300 225 01	35526V*	10-335	281	120	Rak M22	MZ	ALV	5150	8	
13,00x22,5	60 1300 225 02	35527V*	10-335	281	0	Rak M22	MZ	ALV	5150	8	
14,00x22,5	60 1400 225 04	35549V*	10-335	281	0	Rak M22	MZ	ALV	5800	8	
15,00x22,5	60 1500 225 06	11108V*	10-335	281	0	Rak M22	MZ	ALV	5300	8	
15,00x22,5	60 1500 225 02	14003V*	10-335	281	120	Rak M22	MZ	ALV	5300	8	

Fälgar som är markerade med grått är storsäljare!

* = Ventil sitter monterad i fälgen.

** = Utgår vid Slut.

MZ = Mittcentrerad fälg med raka bulthål. Använd endast mutter med rak/plan bricka.

BZ = Bultcentrerad fälg med koniska bulthål på utsidan och i vissa fall även på insidan.

(MZ) = Dessa fälgar kan användas för både mittcentrering och/eller bultcentrering.

Denna typ av fälg kan monteras med både koniska och raka muttrar.

ALV = Alive fälg med ventilen placerad utanför fälgdysken. Anpassad för bilar med skivbroms men passar även till fordon med trumbromsar.

Std = Enbart till fordon med trumbromsar. Ventilen sitter placerad innanför fälgdysken.

DCW-G3 - Vår nyaste generation av lastbilsfälgar



Fälg med hump

Fälg med DCW-G3

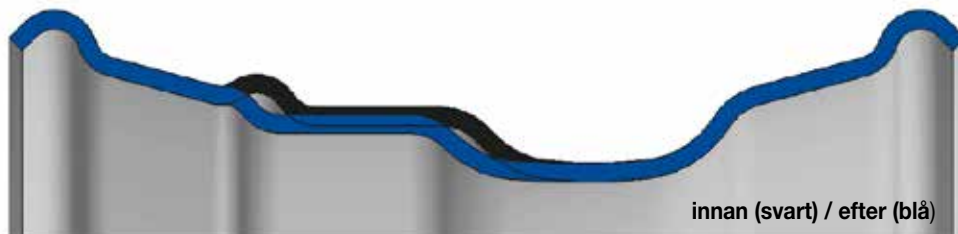









innan (svart) / efter (blå)









Direkt jämförelse

- Ökad nyttolast på grund av ökad viktoptimering (ny form på fälgen)
- Ingen hump - enklare av-/påmontering av däck
- Kompatibel med standard extern ventil (ALV)
- Kompatibilitet med godkända TMP-system
- Finns i alla vanliga fälgdimensioner
- Europeisk OE-kvalitet
- Patenterad utveckling



Fälgdim.	Fälgkod	Beteckning	Art. nummer	Ytfinish	Antal bulthål Bultcirk. PCD	Bulthål Ø mm	Inpr. ET (mm)	ABE- nummer (Tysk- land)	Max. bel. (kg)	Fälgvikt (kg)	Navhål Ø mm	Disk- tjocklek (mm)	Half dual space (mm)	Dubbel- mont.	Ventil- typ
6.75x17.5 6 hole 	SLT 2901	2901AM	700675 175201	Diamond	6-245	26	125	KBA	2 500 49488	14,9	202	21,0	146	Yes	SLT-003
		2901 APH	700675 175101	Höggglans- polerad inv/utv	26										
6.75x17.5 8 hole 	SLT 2911	2911AM	700675 175211	Diamond	8-275	24	125	KBA	2 500 49855	14,4	221	21,0	146	Yes	SLT-003
		2911 APH	700675 175111	Höggglans- polerad inv/utv	24										
		2911 BM	700675 175221	Diamond	30										
		2911 BPH	700675 175121	Höggglans- polerad inv/utv	30										
6.75x17.5 10 hole 	SLT 3086	3086 AM	700675 175231	Diamond	10-225	26	117	KBA	3 000 48650	14,6	176	22,0	139	Yes	SLT-004
7.50x19.5 8 hole 	SLT 3097	3097 AM	700750 195298	Diamond	8-275	26	134	KBA	3 150 48984	18,0	221	21,0	155	Yes	SLT-020
		3097 BM	700750 195297	Diamond	32										
8.25x19.5 8 hole 	SLT 4015	4015 CM	700825 19501	Diamond	8-275	26	145	KBA	3 150 51417	18,8	221	21,0	167	Yes	SLT-003
		4015 AM	700825 19502	Diamond	30										
		4015 BM	700825 19503	Diamond	32										
14.00x19.5 10 hole 	SLT 3598	3598 AM	701400 195201	Diamond	10-335	26	120	KBA	4 500 50537	22,9	281	28,0	~	No	SLT-021
		3598 BM	701400 195202	Diamond	32										
7.50x22.5 	SLT 3211	3211 AM	700750 225201	Diamond	10-335	26	138	KBA	3 750 49688	24,0	281	23,5	162	Yes	SLT-022
		3211 BM	700750 225211	Diamond	32										
8.25x22.5 	SLT 2900	2900 AM	700825 225201	Diamond	10-335	26	146	KBA	3 750 48829	23,3	281	20,5	166,5	Yes	SLT-003
		2900 APH	700825 225101	Höggglans- polerad inv/utv	26										
		2900 BM	700825 225211	Diamond	32										
		2900 BPH	700825 225111	Höggglans- polerad inv/utv	32										
9.00x22.5 	SLT 2917	2917 AM	700900 225202	Diamond	10-335	26	151	KBA	4 250 48286	25,6	281	23,5	174	Yes	SLT-022
		2917 APH	700900 225102	Höggglans- polerad inv/utv	26										
		2917 BM	700900 225212	Diamond	32										
		2917 BPH	700900 225112	Höggglans- polerad inv/utv	32										



Fälgdim.	Fälgkod	Beteckning	Art. nummer	Ytfinish	Antal bulthål Bultcirk. PCD	Bulthål Ø mm	Inpr. ET (mm)	ABE- nummer (Tysk- land)	Max. bel. (kg)	Fälgvikt (kg)	Navhål Ø mm	Disk- tjocklek (mm)	Half dual space (mm)	Dubbel- mont.	Ventil- typ
11.75x22.5 ET 0 	SLT 3099	3099 AM	701175 225221	Diamond	10-335	26	0	KBA	5 000 49335	22,3	281	24,0	~	No	SLT-020
		3099 APT	701175 225121	Högglass- polerad utv.	26										
		3099 BM	701175 225231	Diamond	32										
		3099 BPT	701175 225131	Högglass- polerad utv.	32										
11.75x22.5 ET 45 	SLT 3774	3774 AM	701175 50353	Diamond	10-335	26	45	KBA 50353	5 000	24	281	24,0	~	No	SLT-021
		3774 BM	701175 225271	Diamond	32										
11.75x22.5 ET 120  	SLT 2888/ SLT 3018	3018 AM	701175 225202	Diamond	10-335	26	120	KBA	5 000 48285	25,5	281	26,0	~	No	SLT-021
		3018 APT	701175 225102		26										
		3018 BM	701175 225212	Diamond	32										
		3018 BPT	701175 225112	Högglass- polerad utv.	32										
13.00x22.5 	SLT 3187	3187 AM	701300 225201	Diamond	10-335	26	-14	KBA 49687	5 800	27,9	281	28,0	~	No	SLT-020
		3187 BM	701300 225202	Diamond	32										
9.00x22.5 Design 	SLT 2907	2907 AM	700900 225401	Diamond	10-335	153 26	KBA	4 250 49856	23,7	281	22,0	175	Yes	SLT-003	
		2907 APH	700900 225301	Högglass- polerad inv/utv.	26										
		2907 BM	700900 225411	Diamond	32										
		2907 BPH	700900 225311	Högglass- polerad inv/utv.	32										
11.75x22.5 ET 120 Design 	SLT 2898	2898 AM	701175 225401	Diamond	10-335	26	120	KBA	5 000 48898	24,2	281	25,0	~	No	SLT-021
		2898 APT	701175 225301	Högglass- polerad utv.	26										
		2898 BM	701175 225411	Diamond	32										
		2898 BPT	701175 225311	Högglass- polerad utv.	32										
11.75x22.5 ET 135 Design 	SLT 3063	3063 AM	701175 225441	Diamond	10-335	26	135	KBA	5 000 48899	26,0	281	25,0	~	No	SLT-021
		3063 APT	701175 225341	Högglass- polerad utv.	26										
		3063 BM	701175 225451	Diamond	32										
		3063 BPT	701175 225351	Högglass- polerad utv.	32										

SpecialWheels

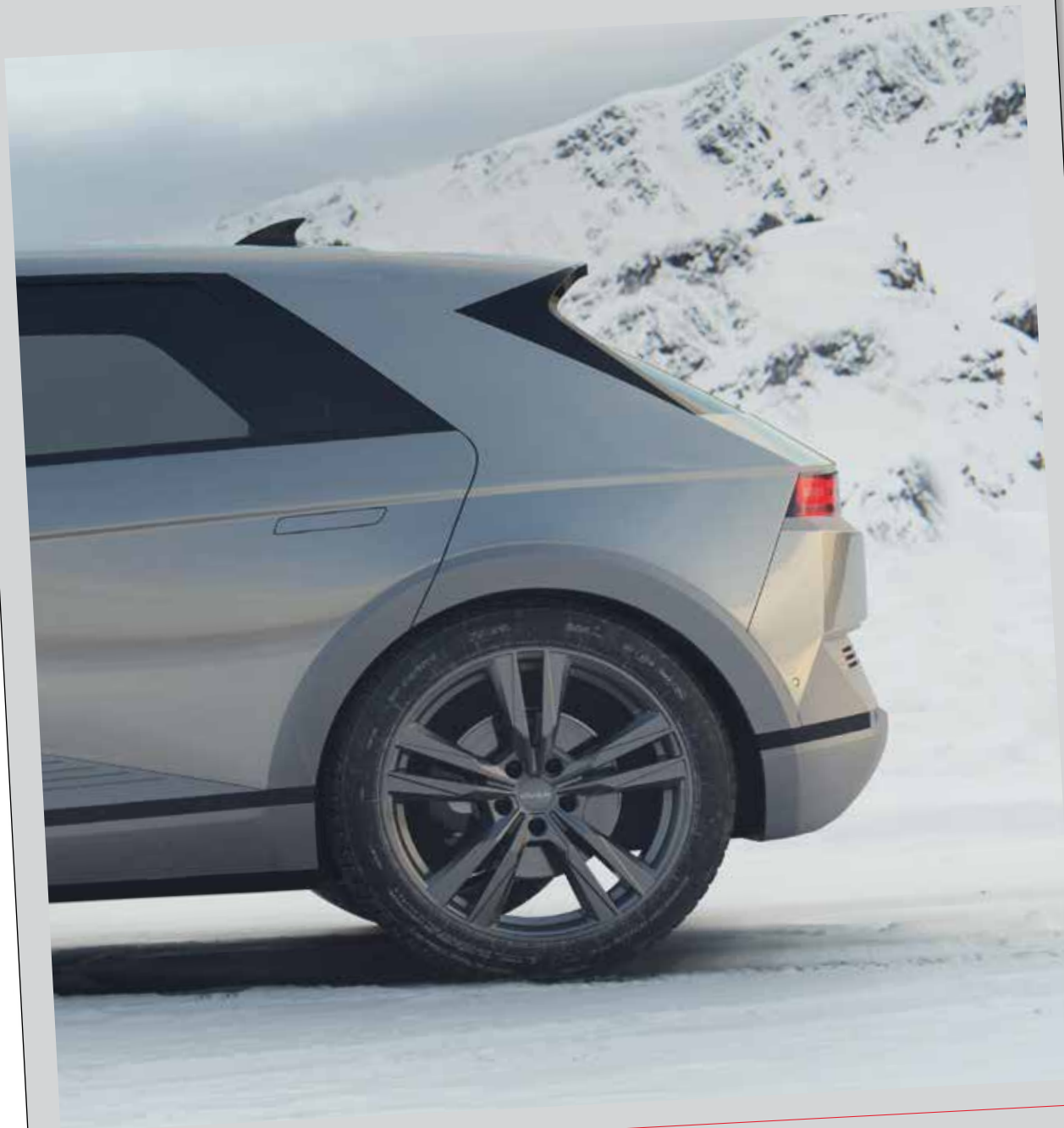

Priser & villkor
Hösten 2022

Innehåller:
Prisbilagor
Information om villkor

SpecialWheels Nordens största oberoende fälgleverantör.

SpecialWheels Fölgar Tillbehör Media Företaget Varumärken Allmänt Ladda hem Webshop

Start > Tesla > 3

BILMODELL	Tesla 3 (003) 17-
BULTCIRKEL	5-114.3
BULTDIM	14x1,50
NAVHÅL	64,1 mm
OFFSET (ET)	40mm / -
REK. DÄCKDIM	235/45R18, 235/40R19, 235/35R20, 275/35R20
ANMÄRKNING	Performance 19", 2020/11 -> Bluetooth TPMS

Egenskaper
 Vintertölig Finns på lager

Diameter
 18" 19" 20" 21"

Tillverkare
 Advanti Racing Image Wheels
 MSW Nitro Wheels
 OZ Racing Sparco

34 / 34



1. Nitro Aero FF G.Bik
2. Nitro Aero FF G.Gun/Pol
3. Nitro Aero FF D.SIV
4. Nitro Throne FF
5. Nitro Sapphire FF
6. Nitro Turismo FF
8. Nitro Volcano G.Gun

För aktuella priser på fälgar se separat distribuerade nettoprislistor alternativt fälgguiden med egen inloggning på:

<https://www.specialfalgar.se/falgar/falgguiden/>

Det går självklart också bra att ringa oss på 0300-72900!



1. Nitro Sting FF G.Blk



2. Nitro Sting FF Slv



3. Nitro Aero FF G.Blk



4. Nitro Aero FF G.Gun/Pol



5. Nitro Aero FF D.Slv



6. Nitro Throne FF G.Blk



7. Nitro Throne FF



8. Nitro Sapphire FF



9. Nitro Turismo FF



10. Nitro Turismo FF G.Gun/Pol



11. Nitro Volcano G.Gun



12. Nitro Volcano



13. Nitro Spark G.Blk/Grey



14. Nitro Spark G.Blk/Red



15. Nitro Sabre G.Blk



SUV & 4X4

16. Nitro Magnum



17. Advanti Inizio DST



FÖR TESLA Y

18. ATS Perfektion D.Grey



FÖR TESLA Y

19. ATS Perfektion M.Blk



20. ATS Auvora Slv



21. ATS Auvora D.Grey



22. ATS Antares



23. ATS Antares G.Blk



24. ATS Evolution



25. ATS Evolution G.Grey



26. ATS Mizar



27. ATS Mizar G.Blk



28. CSP 13



29. CSP 13 M.Gun



30. CSP 15



31. CSP 15 M.Blk



32. CSP 16



33. CSP 16 M.Gun



34. Eta Beta Medusa G.Blk



35. Eta Beta Heron M.Gun/Pol



36. Eta Beta Piuma G.Blk



37. Eta Beta Amos G.Blk/Pol



38. Eta Beta Eros Siv



39. Eta Beta Eros M.Blk



40. Image Colt



40. Image Colt SUV G.Blk/Pol



41. Image Colt L.Gun



41. Image Colt SUV L.Gun



FÖR MERCEDES

42. Image Star FF G.Blk/Pol



FÖR MERCEDES

43. Image Star FF L.Gun



FÖR MERCEDES

44. Image Star FF Slv



45. Image Atom G.Gun



46. Image Atom Slv



47. Image Vega G.Blk



48. Image Vega D.Slv



49. Image Vega M.Gun



51. Image Comet



52. Image Comet Slv



53. Image Stella



54. Image Stella M.Blk



55. Image Legend



56. Image Brio



FÖR SLÄP & HUSVAGN

58. Image Ride



FÖR SLÄP & HUSVAGN

58. Image Ride HL



FÖR SLÄP & HUSVAGN

59. Image Ride HL M.Gun

FÖR MOPEDBILAR



60. Image Rebel

FÖR MOPEDBILAR



61. Image Rebel M.Blk

FÖR VOLVO



62. Image Thor

SUV & 4X4



63. Nitro Hammer

SUV & 4X4



63. Nitro Hammer HL

TRANSPORT-/HUSBIL



64. Image Hercules L.Gun

TRANSPORT-/HUSBIL



66. Image Vector

TRANSPORT-/HUSBIL



67. Image Vector Slv

TRANSPORT-/HUSBIL



69. Image Strong

TRANSPORT-/HUSBIL



70. Image Strong M.Gun

SUV & 4X4



73. Eta Beta Robus M.Blk

SUV & 4X4



74. Image Rough M.Blk

SUV & 4X4



75. Image Montana G.Blk

SUV & 4X4



76. Image Montana Slv

SUV & 4X4



79. BM Macho

SUV & 4X4



80. BM Macho M.Blk

SUV & 4X4



82. Ballistic Dakota

SUV & 4X4



83. Ballistic Morax

FÖR TESLA 3 & Y



86. MSW 27T G.Blk/Pol

FÖR TESLA 3 & Y



87. MSW 27T G.Blk

FÖR TESLA 3 & Y



88. MSW 27T G.Gun



89. MSW 30 G.Blk F.Pol



90. MSW 40 Blk/Pol



91. MSW 41 G.Blk



92. MSW 42 G.Blk



93. MSW 42 G.Blk/Pol



94. MSW 48 M.Blk



95. MSW 50 G.Blk



96. MSW 80 G.Blk/Pol



97. MSW 80 G.Blk



98. MSW 79 Blk/Pol



99. MSW 55 M.Dark Grey



100. MSW 77 Matt Grey



101. MSW 40 Van G.Blk



102. MSW 40 Van G.Blk/Pol



103. MSW 48 Van Blk/Pol

TRANSPORT-/HUSBIL



104. MSW 48 Van

TRANSPORT-/HUSBIL



105. MSW 48 Van Slv

FÖR SUZUKI JIMNY



106. Sparco Dakar



107. CSP 10



108. CSP 10 M.Blk



109. Advanti Peak



110. CSP Work



FÖR BMW & MINI

111. CSP 18



FÖR BMW & MINI

112. CSP 18 G.Blk



FÖR BMW & MINI

113. CSP 18 G.Blk/Pol



NYHET!

114. ATS Competition 2 M.Blk/Pol Lip



NYHET!

115. ATS Passion D.Grey



NYHET!

116. ATS Passion G.Blk/Pol



SUV & 4X4 NYHET!

117. Eta Beta Combat M.Blk



NYHET!

118. Image Dynamic G.Blk



NYHET!

119. Image Dynamic G.Gun



NYHET!

120. Image Dynamic Slv

Nordens största oberoende fälgleverantör.

SpecialWheels

Specialfölgar i Kungsbacka AB

Borgåsvägen 2

434 39 Kungsbacka

Tel. 0300-729 00

www.specialwheels.com